

# CATALOGO GENERALE 2014

# INDICE INDEX

LAME CIRCOLARI  
IN HM

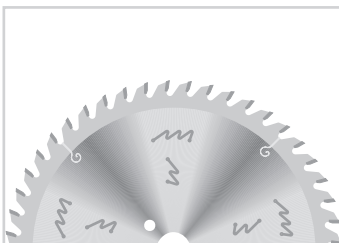

HW CIRCULAR SAW BLADES  
LAMES CIRCULAIRES EN HW  
HOJAS DE SIERRA DE HW

3

TRUCIOLATORI  
HM E PCD



TRIMMING HOGGERS  
DÉCHIQUETEURS  
DESMENUZADORES

85

UTENSILI IN  
DIAMANTE PCD

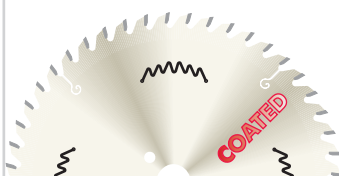

DIAMOND PCD TOOLS  
OUTILS EN DIAMANT PCD  
HERRAMIENTAS DE DIAMANTE PCD

100

PUNTE



BITS  
CONSEILS  
PUNTAS

115

FRESE



MILLING CUTTERS  
CUTTERS  
FRESAS

137

TESTE



HEADS  
TÊTES  
CABEZAS

145

COLTELLI

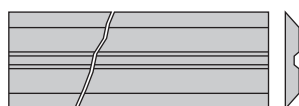

KNIVES  
COUTEAUX  
CUCHILLAS

184



L'azienda è nata nel 1982 in Besenello; i fondatori Oliviero e Zita Adami le hanno dato il nome IMMER e dalla sua fondazione si è sempre distinta per la ricerca di nuovi prodotti e la grande cura qualitativa degli utensili. Nel 1992 con l'entrata dei figli Gianluca e Donatella ha assunto l'attuale nome "G.D.A" e la produzione è stata ulteriormente potenziata e automatizzata fino ad arrivare ad oggi, dove tutte le fasi sono robotizzate. L'ottimo risultato ottenuto ha permesso l'introduzione della G.D.A. in ogni continente, facendone una delle maggiori realtà nella costruzione di lame circolari in metallo duro. Nel 2006 il continuo sviluppo dell'azienda ha permesso la realizzazione della "G.D.A. Trade", con sede e deposito in Repubblica Ceca e l'obiettivo di aumentare maggiormente la presenza e il servizio offerto nei paesi del centro-est Europa.



The production started in 1982 in Besenello with IMMER's name from Oliviero and Zita Adami. From the beginning the factory's been distinguished for the constant development, particularly for the research of new products and for the quality and the improvement of the articles already in production. In 1992 with the entry of their children Gianluca and Donatella it took the actual name "G.D.A." and actually after the continuous development, all the lines of production are robotized. Thanks to the excellent result, the G.D.A.'s circular saw blades have been exported in every continent and G.D.A. is now one of the most important producers. In 2006 the G.D.A has realized the "G.D.A. trade" with office and warehouse in the Ceca Republic in order to better satisfy the customers in the middle-east Europe and to be always more representative in the market.



La société a été fondée en 1982 à Besenello avec le nom IMMER par Oliviero et Zita Adami. L'usine s'est toujours distinguée pour le constant développement en particulier pour la recherche de nouveaux produits et pour l'amélioration et le perfectionnement des articles déjà en production. En 1992 avec l'entrée des fils Gianluca et Donatella, l'entreprise a pris le nom « G.D.A. » et la production a été encore améliorée jusqu'à présent où toutes les étapes sont automatisées. L'excellent résultat a permis l'introduction des scies circulaires GDA dans chaque continent, en y faisant de la même, un des plus importants producteurs des scies circulaires actuellement existantes. En 2006, le développement de l'entreprise a permis la réalisation de la GDA Trade avec le siège et l'entrepôt dans la République Ceca, visée à accroître la présence et le service dans les pays de l'Europe du centre est.



La empresa nació en el 1982 a Besenello; los fundadores Oliviero y Zita Adami le han dado el nombre IMMER y desde su fundación siempre se ha caracterizada por la búsqueda de nuevos productos y la gran cura de calidad de los utensilios. En el 1992 con la entrada de los hijos Gianluca e Donatella han tomado el actual nombre "G.D.A." y la producción tomo ulteriormente potencialidad y con automatización hasta llegar a hoy día, donde todas las fases son robotizadas. El óptimo resultado alcanzado ha permitido la introducción de la G.D.A. en cada continente, haciendo una de las mejores realidades en la construcción de hojas circulares en metal duro. En el 2006 el continuo desarrollo de la empresa ue ha permitido la realización de la "G.D.A. Trade", con sede y deposito en República Checa con el objetivo de aumentar mayormente la presencia y el servicio ofrecido en los países del centro - este Europa.

## GDA E L'AMBIENTE

la GDA è situata in Trentino Alto Adige, un luogo noto a tutto il mondo per la bellezza delle proprio montagne, le Dolomiti, da poco patrimonio dell'UNESCO, dei propri laghi ed in generale per la cura posta a tutto l'ambiente. Da sempre quindi la nostra azienda ha cercato, per quanto possibile, di usare al proprio interno sistemi e materiali che oltre a garantire un'ottima funzionalità per i nostri clienti, fossero il più possibile eco compatibili. L'ultimo grande investimento del 2009 è stato realizzato sul tetto dell'azienda, un impianto fotovoltaico della potenza di 150 KW, questo ci permetterà di produrre circa 180.000 KW/anno con un risparmio di 20 ton di CO2/anno immesse nell'ambiente. Un altro piccolo passo per la salvaguardia dell'ambiente in cui viviamo.

## GDA AND THE ENVIRONMENT

The company GDA is situated in Trentino Alto Adige, a place known worldwide for the beauty of its mountains, DOLOMITI recently UNESCO, its lakes and in general for the care to the whole environment. Then our company has always tried, wherever possible, to use its internal systems and materials as well as ensuring excellent functionality for our customers, were as environmentally friendly as possible. The last major investment in 2009 was carried out on the roof of the company, a photovoltaic power of 150 kW, this will enable us to produce about 180.000 Kw/year, with a saving of 20 Ton of CO2 of placing environmental NOT released. Another small step to safeguard our environment.



### Lame universali

Universal saw blades

Lames universelles

Hojas universales

#### IM 102



#### IM 104



#### IM 106



#### IM 108



#### IM 110



#### IM 112



#### IM 113



#### IM 114



#### IM 115



### Lame per pannelli

Saw blades for panel

Lames pour panneaux

Hojas para tobleros

#### IM 116



#### IM 117



#### IM 118



#### IM 119



#### IM 120

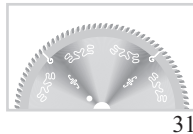

### Lame per cornici e materiali plastici

Saw blades for frames and plastic materials

Lames pour cadres et matériaux en plastiques

Hojas para molduras y materiales de plástica

#### IM 121



#### IM 122



### Lame per spessori sottili

Saw blades with thin thickness

Lames avec épaisseur fin

Hojas a espesor sotil

#### IM 123



#### IM 124



#### IM 125



#### IM 126

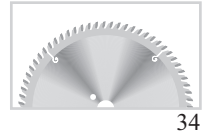

#### IM 127

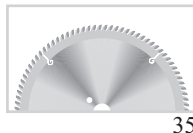

#### IM 128



#### IM 129



### Lame speciali regolabili e a grosso spessore

Adjustable and big thickness special saw blades

Lames speciaux réglables et à épaisseur grand

Hojas especiales regables y a espesor grande

#### IM 130



#### IM 132

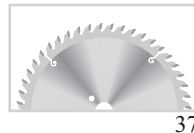

### Lame a grande diametro

Saw blades with big diameter

Lames avec diamètre grand

Hojas a diametro grande

#### IM 138



#### IM 139



### Lame per multilama

Saw blades for multirip saw machine

Lames pour machine multilames

Hojas para sierra multiple

#### IM 140



#### IM 141



#### IM 142



#### IM 143



#### IM 144



#### IM 145



#### IM 146



#### IM 147



#### IM 147/A



#### IM 148

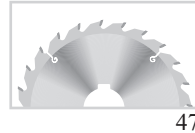

#### IM 149

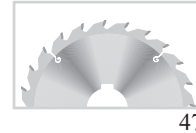

#### CANTER

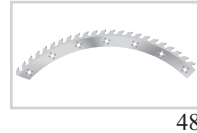

### Lame e incisori per sezionatrici

Saw blades and scores for panel saws

Lames et inciseurs pour scies à panneaux

Hojas y incisores para despieceado de tableros

#### IM 154

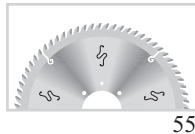

#### IM 156

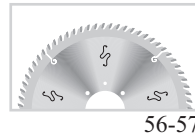

#### IM 157



#### IM 158

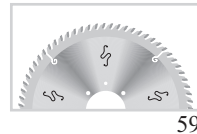

#### IM 160

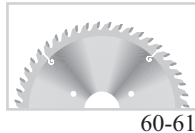

#### IM 162



#### IM 163



#### IM 165

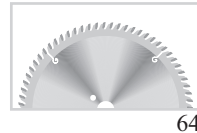

#### IM 166

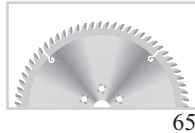

#### IM 168



### Lame per scanalature, macchine radiali e macchine ottimizzatrici

Grooving saw blades, radial and optimizing machines

Lames pour rainures, machines radiaux et optimisantes

Hojas para ranurar, maquinas radials y optimizantes

#### IM 170



#### IM 171

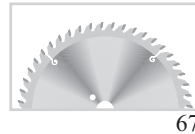

#### IM 172



### Lame per alluminio e PVC

Saw blades for aluminium and PVC

Lames pour aluminium et PVC

Hojas para aluminio y PVC

#### IM 174

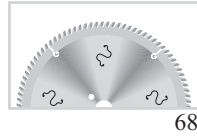

#### IM 176

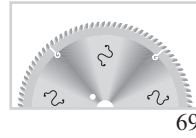

#### IM 177



#### IM 178

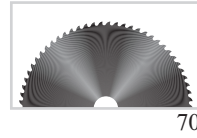

#### IM 179



### Lame per metalli ferrosi

Saw blades for ferrous metal

Lames pour métaux ferreux

Hojas para metales ferrosos

#### IM 180



#### IM 181



### Lame per edilizia

Saw blades for building

Lames pour construction

Hojas para construcciones

#### IM 182



#### IM 183



### Lame per portatili

Saw blades for portable machines

Lames pour machine portables

Hojas para maquinas portatiles

#### IM 186

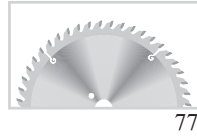

#### IM 187

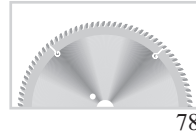

### Lame e settori per truciolatori

Saw blades and segments for trimming hogs

Lames et segments pour déchiqueteurs

Hojas y segmentos para desmenuzadores

#### IM 194

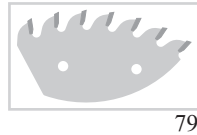

#### IM 196



### Lavorazioni speciali, riduzioni e anelli distanziali

Special productions, reduction and spacing rings

Travaux speciaux, bagues de réduction et de distance

Elaboraciones especiales, anillos de reduccion y distanciadores

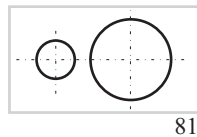

#### IM 198

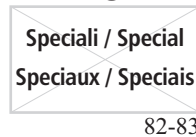

#### IM 199

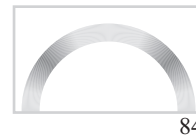

#### IM 199/A

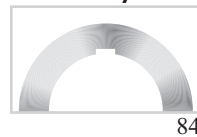

# MODO D'IMPIEGO DELLE LAME CIRCOLARI

## HOW TO USE CIRCULAR SAW BLADES

## MODE D'EMPLOI DES SCIES CIRCULAIRES

## MODO DE EMPLEO DE LAS HOJAS CIRCULARES

**I** Per ottenere un buon taglio è necessario che 2 o 3 taglienti lavorino contemporaneamente (Fig.1).

**GB** If you want to obtain a good cutting quality it is necessary to have two or three teeth working at the same time (Fig. 1).

**F** Pour obtenir une bonne qualité de coupe c'est nécessaire que 2 ou 3 dents travaillent en même temps (Fig.1).

**E** Para que una sierra pueda cortar satisfactoriamente es necesario que por los menos dos o tres dientes trabajen a la vez (Fig.1).

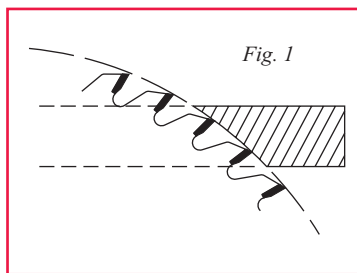

**I** Se lavora un solo tagliente non si ottiene una buona finitura (Fig.2).

**GB** It is impossible to obtain a good cutting quality if only one tooth is working (Fig. 2).

**F** C'est impossible obtenir une bonne qualité de coupe si seulement un dent travaille (Fig.2).

**E** Es imposible que una sierra pueda cortar satisfactoriamente si solo un diente trabaja (Fig.2).

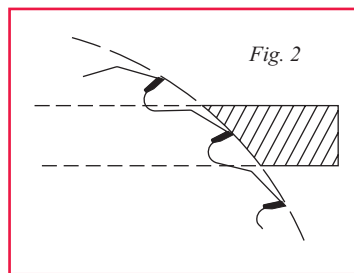

**I** Con l'aumentare di "C", diminuisce la scheggiatura della superficie "A" e aumenta quella della superficie "B". Quando "C" diminuisce avviene il contrario (Fig.3).

**GB** When "C" increases, the chipping of top face "A" decreases, and the chipping of bottom face "B" increases. When "C" decreases "B" decreases and "A" increases (Fig. 3).

**F** Quand "C" augmente, l'ébèchement de la surface "A" décroît et l'ébèchement de la surface "B" augmente. Quand "C" décroît, "B" décroît et "A" augmente (Fig.3).

**E** Con el aumentar de "C" decrece el astillado de la superficie "A" y aumenta así la superficie "B" cuando "C" decrece sucede el contrario (Fig.3).

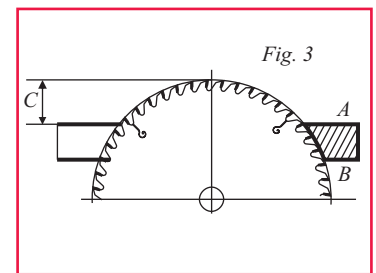

**ORDINAZIONI:** nella compilazione dell'ordine precisare:

- 1) Articolo dell'utensile
- 2) Dimensioni dell'utensile (D x B x d x Z)
- 3) Numero di codice

- = Lame pronte a magazzino
- △ = Lame con consegna rapida
- = Lame da costruire
- \* = Prezzo a richiesta
- 🚫 = Eco-sil
- 🚫 = Sil (Black Silent)
- 🚫 = Ultra-sil

**COMMANDE:** préciser les données:

- 1) Article de l'utensile
- 2) Dimension de l'utensile (D x B x d x Z)
- 3) Numero du code

- = Scies circulaires en magasin
- △ = Scies circulaires avec rapide livraison
- = Scies circulaires à construire
- \* = Prix sur demande
- 🚫 = Eco-sil
- 🚫 = Sil (Black Silent)
- 🚫 = Ultra-sil

**ORDERS:** data to be specified:

- 1) Article of the tool
- 2) Dimension of the tool (D x B x d x Z)
- 3) Number of the code

- = Saw blades in stock
- △ = Saw blades with fast delivery
- = Saw blades to be produced
- \* = Price on request
- 🚫 = Eco-sil
- 🚫 = Sil (Black Silent)
- 🚫 = Ultra-sil

**ORDENES:** datos para hacer el pedido:

- 1) Denominación de la herramienta
- 2) dimensiones de la herramienta (D x B x d x Z)
- 3) Numero del código

- = Hoja de sierra en stock
- △ = Hoja de sierra con entrega rapida
- = Hoja de sierra para construir
- \* = Precio a petición
- 🚫 = Eco-sil
- 🚫 = Sil (Black Silent)
- 🚫 = Ultra-sil

# ISTRUZIONI PER L'USO CORRETTO DELLE LAME

## INSTRUCTIONS FOR THE RIGHT USE OF THE SAW BLADES

### INSTRUCTIONS POUR LE CORRECT USAGE DES SCIES CIRCULAIRES

### INSTRUCCIONES PARA EL USO CORRECTO DE LAS HOJAS

Controllare che la lama che si sta montando sia idonea al lavoro da eseguire (ved. pag. 14), perfettamente pulita e non presenti alcuna alterazione provocata da urti o da altri incidenti.

Controllare che l'albero su cui va montata sia:  
- perfettamente diritto  
- del diametro del foro della lama e in tolleranza H7.

Le flange di bloccaggio devono essere:  
- di diametro uguale  
- di diametro minimo di 1/3 della lama  
- perfettamente parallele e ben pulite  
- con il foro ortogonale al piano di appoggio

Eventuali anelli distanziali devono essere paralleli e ben puliti.

Controllare spesso l'affilatura delle lame e riaffilarle appena necessario mantenendo inalterate le geometrie originali dei denti.

Prima di iniziare la lavorazione controllare che:  
- la lama sia ben bloccata.  
- la velocità di rotazione sia quella giusta per la lama montata.

You have to check that the saw blade that you are assembling should be perfectly cleaned and suitable for the job you have to do (see page 14) and it doesn't have alterations caused by bumps or other accidents.

The tree for the assemblage must be:  
- perfectly straight  
- with the same diameter of the hole of the blade and with tolerance H7

The blocking flanges must be:  
- with the same diameter between them.  
- with the diameter of minimum 1/3 of the diameter of the blade  
- perfectly parallels and cleaned  
- with the hole orthogonal to the support plan

If there are spacers, they must be parallels and perfectly cleaned.

You've to check frequently the sharp of the blade: the blades need to be immediately sharpened when it's necessary keeping unchanged the original geometries of the teeth.

Before working you have to check that:  
- the blade should be perfectly blocked  
- the rotation speedy should be right for the blade you've assembled

Vérifier que la lame que vous êtes en train de monter soit indiquée pour le travail que vous devez faire (voir page 14), qu'elle soit parfaitement nettoyée et qu'elle ne soit pas endommagée (heurts ou autres accidentes).

L'arbre pour l'assemblage doit être:  
- parfaitement droit  
- avec le même diamètre du trou de la lame et tolérance H7

Vérifier que les brides d'attachement (pour le blocage) soient:  
- du même diamètre  
- avec un diamètre minimum de 1/3 de la lame  
- parfaitement parallèles et nettoyées  
- avec le trou orthogonal au plan de soutien

Les éventuels bagues de distance doivent être parfaitement parallèles et nettoyées.  
Vérifier souvent l'affûtage des lames et leur donnez le fil toute suite s'il est nécessaire, en maintenant inaltérées les géométries originales des dents.

Avant de commencer le travail, vérifier que:  
- la lame soit bien bloquée  
- la vitesse de rotation soit celle exacte pour la lame que vous devez utiliser.

Controlar que la hoja que se está montando sea idonea al trabajo deseado (ver pag. 14) Perfectamente limpia y que no presente ninguna alteracion probocada por golpes u otros accidentes.

Controlar que el arbol de leva en el cual se monta sea:  
- perfectamente derecho  
- del diametro del orificio de la hoja y tolerancia H7

Controlar que las bridas del bloqueo sean:  
- de diametro igual  
- de diametro minimo de 1/3 de la hoja  
- perfectamente paralelas y bien limpias  
- con el orificio ortogonal al plano de apoyo

Eventuales anillos separadores deben ser paralelos y limpios.

Controlar muy seguido la afilacion de las hojas y reaflarlas apenas sea necesario manteniendo inalterada la geometria original de los dientes.

Controlar antes de iniciar el trabajo que:  
- la hoja sea bien blocada  
- la velocidad de rotacion sea la deseada para la hoja montada



# GEOMETRIA DELLE LAME CIRCOLARI

## GEOMETRY OF CIRCULAR SAW BLADES

### GEOMETRIE DES LAMES DES SCIES CIRCULAIRES

### GEOMETRIA DE LAS HOJAS DE SIERRA CIRCULARES

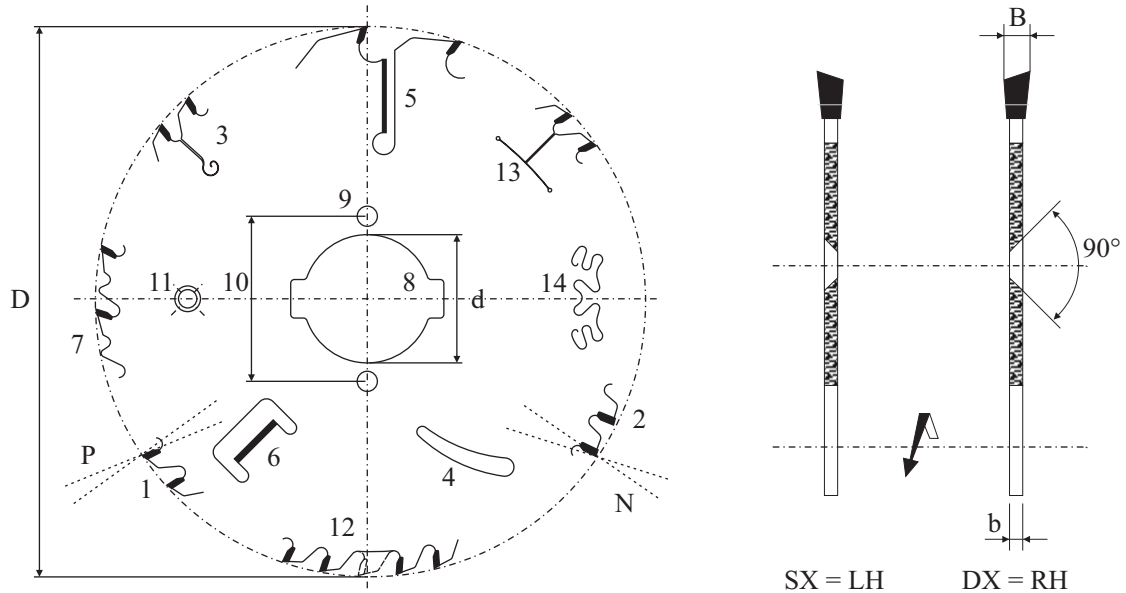

#### INFORMAZIONE TECNICA

1	Angolo di attacco positivo	8	Chiavetta singola o doppia	D	Diametro esterno
2	Angolo di attacco negativo	9	Foro di trascinamento	B	Spessore di taglio
3	Taglio di dilatazione	10	Interasse fori di trascinamento	b	Spessore del corpo della lama
4	Cava di raffreddamento	11	Foro svasato per vite di fissaggio	d	Diametro del foro
5	Rasante esterno	12	Vano dente del settore	DX	Rotazione destra
6	Rasante interno	13	Taglio di semi - silenziatura	SX	Rotazione sinistra
7	Limitatore di truciolo	14	Taglio di silenziatura	Z	Numero dei taglianti

#### TECHNICAL INFORMATION

1	Positive hook angle	8	Single or double keyway	D	Outside tool diameter
2	Negative hook angle	9	Pin hole	B	Tooth thickness
3	Expansion slot	10	Pitch circle	b	Saw body thickness
4	Cooling slot	11	Countersink holes	d	Bore diameter
5	Outside wiper slot	12	Recess for hogger attachment	DX	Right hand rotation
6	Inside wiper slot	13	Semi low noise cut	SX	Left hand rotation
7	Chip limiter	14	Low noise cut	Z	Number of teeth

#### INFORMATION TECHNIQUE

1	Angle d'attaque positif	8	Rainure de clavette	D	Diamètre extérieur
2	Angle d'attaque négatif	9	Trou d'entraînement	B	Épaisseur du dent
3	Fente de dilatation	10	Circle de perçage	b	Épaisseur du corps de lame
4	Fente de refroidissement	11	Trou fraisé pour le fixage	d	Diamètre de l'alesage
5	Racleur extérieur	12	Echancrure pour dechiqueteur	DX	Rotation a droite
6	Racleur intérieur	13	Taillage semi silencieux	SX	Rotation a gauche
7	Limiteur de coupe	14	Taillage silencieux	Z	Nombre de dents

#### INFORMACION TECNICA

1	Angulo de ataque positivo	8	Llave singular o doble	D	Diametro externo
2	Angulo de ataque negativo	9	Orificio arrastrador	B	Espesor de corte
3	Junta de dilatacion	10	Circula de referencia	b	Espesor del cuerpo de la hoja
4	Ranura de refrigeracion	11	Taladro avellanado	d	Diametro del orificio
5	Rasurador externo	12	Hueco para segmento	DX	Giro a la derecha
6	Rasurador interno	13	Corte para sierra semi silenciosa	SX	Giro a la izquierda
7	Limitador viruta	14	Corte para sierra silenciosa	Z	Numero de dientes

# GEOMETRIA DELLE LAME CIRCOLARI

## GEOMETRY OF CIRCULAR SAW BLADES

### GEOMETRIE DES LAMES DES SCIES CIRCULAIRES

### GEOMETRIA DE LAS HOJAS DE SIERRA CIRCULARES

#### INFORMAZIONE TECNICA

AT	Angolo di attacco ( positivo o negativo)
TA	Angolo di taglio
SP	Angolo di spoglia superiore
AS	Angolo assiale
SL	Angolo di spoglia laterale
SR	Angolo di spoglia radiale
IN	Angolo di incisione
CN	Angolo di conicità

#### TECHNICAL INFORMATION

AT	Rake angle (positive or negative)
TA	Wedge angle
SP	Clearance angle
AS	Axle angle
SL	Side clearance angle
SR	Radial side angle
IN	Top bevel angle
CN	Conical angle

#### INFORMATION TECHNIQUE

AT	Angle d'attaque (positif ou negatif)
TA	Angle de coupe
SP	Angle de depouille
AS	Angle d'axe
SL	Angle de depouille laterale
SR	Angle de depouille radiale
IN	Angle d'incision
CN	Angle conique

#### INFORMACION TECNICA

AT	Angulo de ataque (positivo o negativo)
TA	Angulo del diente cuna
SP	Angulo de salida
AS	Angulo axial
SL	Angulo de salida lateral
SR	Angulo de salida radial
IN	Angulo de inclinacion
CN	Angulo conico

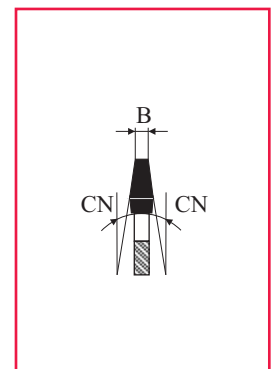
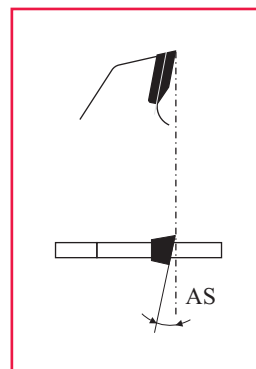
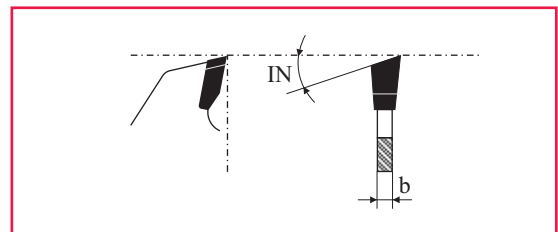
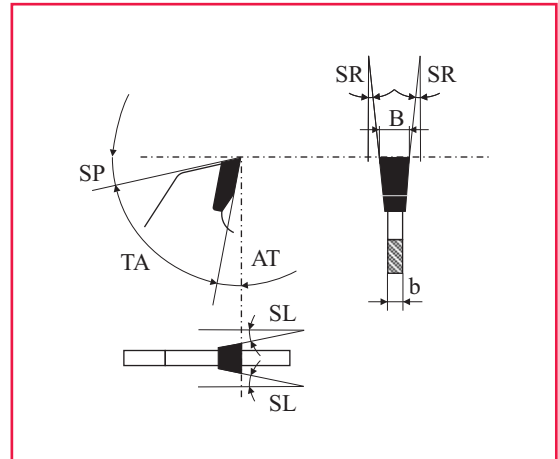

# TABELLA FORI TRASCINAMENTO

## TABLE FOR PIN HOLES

### TABLEAU POUR LES TROUS D'ENTRAÎNEMENT

### CUADRO POR LOS ORIFICIOS ARRASTRADORS

Sotto sono stati indicati i fori presenti nel catalogo con le principali macchine a cui si adattano. I disegni sono in scala 1:1 per cui in caso di dubbio, basta sovrapporre la lama al disegno per verificare se i propri fori sono compatibili. In ogni caso è sempre possibile produrre o modificare le lame circolari secondo le esigenze del cliente.

Below are shown the holes you can find in the catalogue with the most important machines that fit. Drawings are 1:1 scale so if in doubt, just overlap the blade to the design to see if their holes are compatible. In any case it is always possible to produce or modify the circular blades according to customer requirements.

Ci-dessous ils sont indiqués les alésages que vous pouvez trouver dans ce catalogue, avec les principales machines auxquelles ils s'ajustent. Les dessins sont à l'échelle de 1 : 1 et, en cas de doute, il suffira superposer la lame au dessin pour vérifier si vos alésages sont compatibles.

Aquí abajo estan indicados los orificios que se pueden encontrar en este catálogo, con las máquinas principales a que se acomodan. Los dibujos son en escala de 1 : 1 y, en caso de duda, es suficiente superponer la hoja a el dibujo para comprobar si los orificios son compatibles.

En tout cas, c'est toujours possible produire ou modifier les lames circulaires selon les exigences du client.

En cualquier caso, es siempre posible producir o modificar las hojas de sierra según los requisitos del cliente.

### MISURE FORI TRASCINAMENTO / PIN HOLES DIMENSION

### MEASURES TROUS D' ENTRAÎNEMENT / MEDIDAS ORIFICIOS ARRASTRADORS

Nome / Name Prénom / Nombre	Dimensioni / Dimension Dimensions / Dimensiones	Macchine / Machines Machines / Máquinas
PH2	2/7/42 + 2/9,5/46,5 + 2/10/60	Combinazione universale / Universal Combination
PH4	2/14/110 + 2/7/110 + 4/9/100 + 4/19/120 + 2/9/130	GABBIANI - SCM - SELCO
PH5	4/15/105 + 3/7/100	GIBEN - HOMAG - MACMAZZA

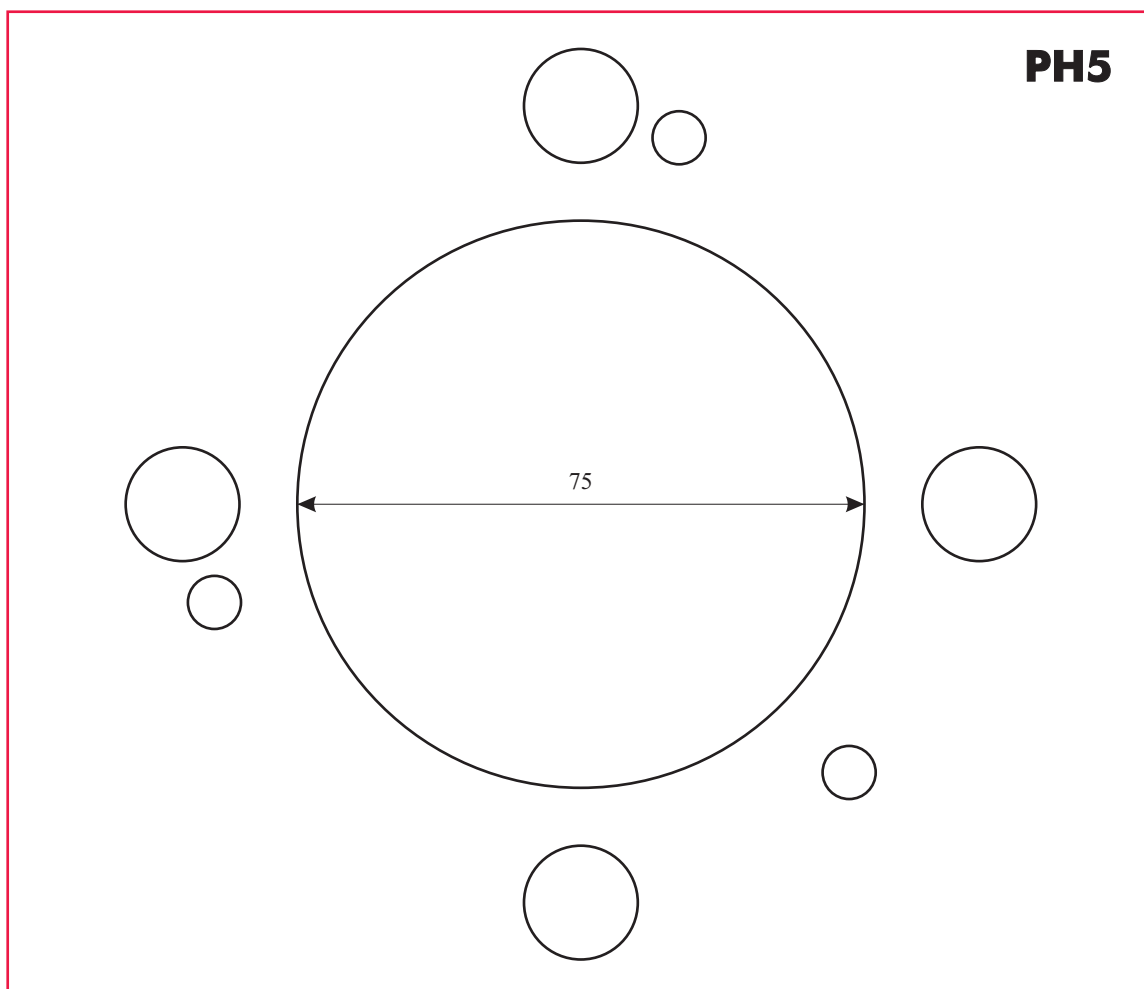

**TABELLA FORI TRASCINAMENTO**  
**TABLE FOR PIN HOLES**  
**TABLEAU POUR LES TROUS D'ENTRAÎNEMENT**  
**CUADRO POR LOS ORIFICIOS ARRASTRADOS**

**PH2**

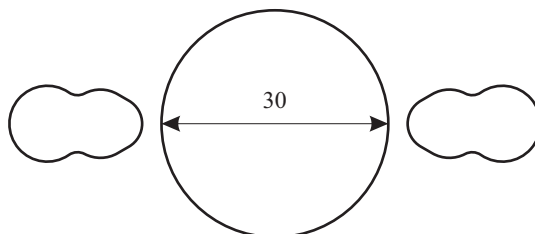

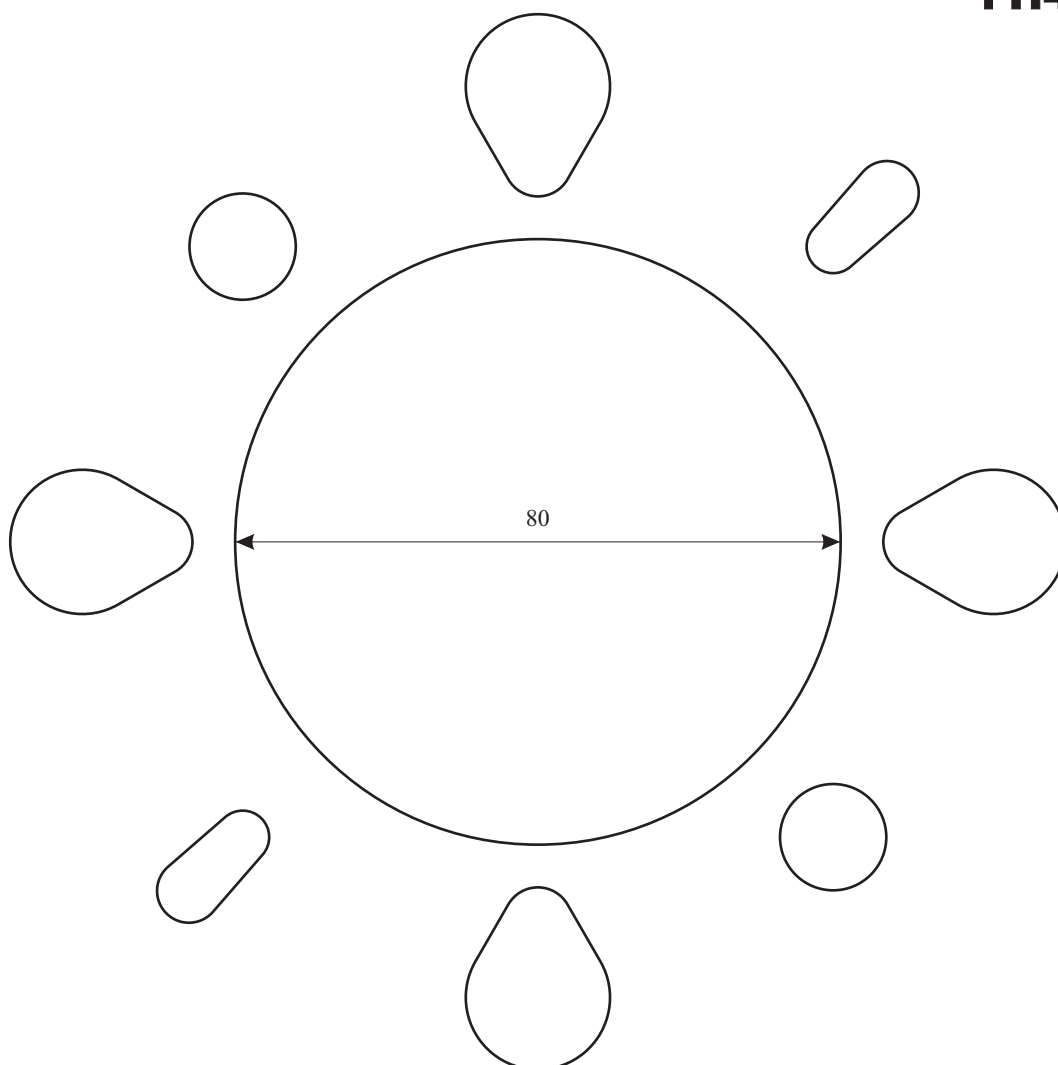

**PH4**

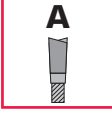
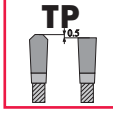
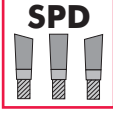
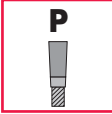
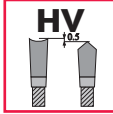
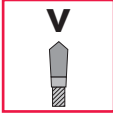
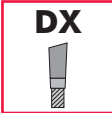
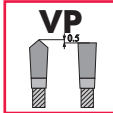
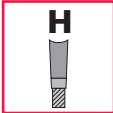

# FORMA DEI TAGLIANTI

## TEETH FORM FORME DE DENTURES FORME DE LOS DIENTES

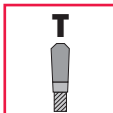
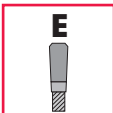
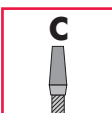
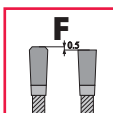
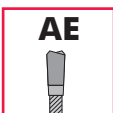
	Dente alternato Alternate bevel tooth Denture alternée Diente alterno		Dente trapezio-piano Trapezoidal-flat tooth Denture trapézoïdale-plate Diente trapezoidal-recto		Dente sinistro-piano-destro Left-flat-right tooth Denture gauche-plate-droite Diente izquierdo-recto-derecho
	Dente piano Flat tooth Denture plate Diente recto		Dente concavo punta Inverted V-hollow tooth Denture concave pointue Diente concavo en punta		Dente a punta Inverted V-tooth Denture pointue Diente en punta
	Dente destro Tooth with right-hand bevels Denture biaisée à droite Diente biselados a la derecha		Dente punta-piano Inverted-V-flat tooth Denture toit et plate Diente punta y recto		Dente concavo Hollow tooth Denture concave Diente concavo
	Dente sinistro Tooth with left-hand bevels Denture biaisée à gauche Diente biselados a la izquierda		Dente trapezoidale Trapezoidal tooth Denture trapézoïdale Diente trapezoidal		Dente sbozzatore Flat tooth with bevels Denture plate avec biseaux Diente recto con bisels
	Dente conico Conical tooth Denture conique Diente conico		Dente sbozzatore-piano Trapezoidal-flat tooth Denture trapézoïdale-plate Diente trapezoidal-recto		Dente alternato-sbozzatore Alternate tooth with bevels Denture alternée avec biseaux Diente alterno con bisels

## DETERMINAZIONE DELLA VELOCITÀ PERIFERICA (V<sub>c</sub>)

### HOW TO DETERMINE THE PERIPHERAL CUTTING SPEED (V<sub>c</sub>) DETERMINATION DE LA VITESSE PERIPHERIQUE DE COUPE (V<sub>c</sub>) DETERMINACIÓN DE LA VELOCIDAD PERIFERICA DE CORTE (V<sub>c</sub>)

$$V_c = \frac{\pi \times D \times n}{60 \times 1000}$$

D = diametro - diameter - diamètre - diámetro

n = numero giri - revolution number - nombre de tours - número de giros

V<sub>c</sub> (m/s) = velocità periferica - peripheral cutting speed - vitesse peripherique - velocidad periferica

n (g/min)	D (mm)														
	80	100	125	150	180	200	225	250	280	300	350	400	450	500	550
1000	-	-	-	-	-	10,5	12	13	14,5	16	18,5	21	23,5	26	29
1500	-	-	10	12	14	15,5	17,5	19,5	22	23,5	27,5	31,5	35,5	39,5	43
2000	-	10,5	13	15,5	19	21	23,5	26	29,5	31,5	36,5	42	47	52,5	57,5
2500	10,5	13	16,5	19,5	23,5	26	29,5	32,5	36,5	39	46	52,5	59	65,5	72
3000	13	15,5	19,5	23,5	28	31,5	35,5	39	44	47	55	63	70,5	78,5	86,5
3500	15	18,5	23	27,5	33	36,5	41	46	51,5	55	64	73,5	82,5	91,5	-
4000	17	21	26	31,5	37,5	42	47	52,5	58,5	63	73,5	84	94	-	-
4500	19	23,5	29,5	35,5	42,5	47	53	59	66	70,5	82,5	94	-	-	-
5000	21	26	32,5	39	47	52,5	59	65,5	73	78,5	91,5	-	-	-	-
5500	23	29	36	43	52	57,5	65	72	80,5	86,5	-	-	-	-	-
6000	25	31,5	39,5	47	56,5	63	70,5	78,5	88	94	-	-	-	-	-
6500	27	34	42,5	51	61,5	68	76,5	85	95,5	-	-	-	-	-	-
7000	29,5	36,5	46	55	66	73,5	82,5	91,5	-	-	-	-	-	-	-
7500	31,5	39,5	49	59	70,5	78,5	88,5	98	-	-	-	-	-	-	-
8000	33,5	42	52,5	63	75,5	84	94	-	-	-	-	-	-	-	-
8500	35,5	44,5	55,5	67	80	89	100	-	-	-	-	-	-	-	-
9000	37,5	47	59	70,5	85	94	-	-	-	-	-	-	-	-	-
9500	40	50	62	74,5	89,5	99,5	-	-	-	-	-	-	-	-	-
10000	42	52,5	65,5	78,5	94	-	-	-	-	-	-	-	-	-	-

# DETERMINAZIONE DELLA VELOCITÀ DI AVANZAMENTO DEL MATERIALE (Vf)

## HOW TO DETERMINE THE MATERIAL FEED RATE (Vf)

### DETERMINATION DE LA VITESSE D'AVANCEMENT DU MATÉRIEL (Vf)

### DETERMINACIÓN DE LA VELOCIDAD DE AVANCE DEL MATERIAL (Vf)

$$Vf = \frac{Z \times n \times Cz}{1000}$$

Z = numero dei denti - number of teeth - nombre de dents - numero de dientes

n = numero giri - revolution number - nombre de tours - numero de giros

Cz = avanzamento per dente - feed rate/tooth - avance/dents - avance/diente

Z										Cz (mm)	
6	12	24	36	48	60	72	80	96	120	FINITURA 0,03 ÷ 0,06	SGROSSATURA 0,1 ÷ 0,2
2000	1000	500	-	-	-	-	-	-	-	0,36 ÷ 0,72	1,2 ÷ 2,4
3000	1500	750	500	-	-	250	-	-	-	0,54 ÷ 1,08	1,8 ÷ 3,6
4000	2000	1000	-	500	-	-	-	-	-	0,72 ÷ 1,44	2,4 ÷ 4,8
5000	2500	1250	-	-	500	-	-	-	-	0,90 ÷ 1,80	3,0 ÷ 6,0
6000	3000	1500	1000	750	-	500	-	-	-	1,08 ÷ 2,16	3,6 ÷ 7,2
7000	3500	1750	-	-	-	-	-	-	-	1,26 ÷ 2,52	4,2 ÷ 8,4
8000	4000	2000	-	1000	800	-	-	500	-	1,44 ÷ 2,88	4,8 ÷ 9,6
9000	4500	2250	-	-	900	-	-	-	-	1,62 ÷ 3,24	5,4 ÷ 11,2
10000	5000	2500	-	1250	1000	-	-	-	-	1,80 ÷ 3,60	6,0 ÷ 12,0
12000	6000	3000	2000	1600	1200	1000	-	-	-	2,16 ÷ 4,32	7,2 ÷ 14,4
16000	8000	4000	-	2000	1600	-	-	1000	800	2,88 ÷ 5,76	9,6 ÷ 19,2
-	9000	4500	3000	2250	1800	1500	1350	-	900	3,24 ÷ 6,48	10,8 ÷ 21,6
-	12000	6000	4000	3000	2400	2000	1800	1500	1200	4,32 ÷ 8,64	14,4 ÷ 28,8
-	-	7500	5000	3750	3000	2500	2250	-	1500	5,40 ÷ 10,8	18,0 ÷ 36,0
-	16000	8000	-	4000	3200	-	2400	2000	1600	5,76 ÷ 11,52	19,2 ÷ 38,4
-	-	9000	6000	-	3600	3000	2700	2250	1800	6,48 ÷ 12,96	21,6 ÷ 43,2
-	-	10000	-	5000	4000	-	3000	2500	2000	7,20 ÷ 14,40	24,0 ÷ 48,0
-	-	12000	8000	6000	4800	4000	3600	3000	2400	8,64 ÷ 17,28	28,8 ÷ 57,6

n (g/min)

Vf (m/min)

La presente tabella rappresenta il numero massimo di giri (limite di sicurezza) a cui possono essere sottoposte le lame, ma non rappresenta il numero di giri ideale.

This table does not represent the ideal number of revolutions, but only the highest number of revolutions to keep (observe) the safety-limit.

Cette tableau ne représente pas le nombre idéal de tours, mais le maximum nombre de tours consenti pour respecter la limite de sûreté.

Este prospecto no representa el número ideal de giros, sino el número máximo de giros consentido para respetar el límite de seguridad.

D (mm)																
100	125	150	180	200	250	300	350	400	450	500	550	600	650	700	760	800
15.000	12.000	12.000	10.000	10.000	8.000	6.000	6.000	4.500	4.000	3.500	3.000	2.800	2.500	2.300	2.100	2.000

n max (g/min)

Le quote riportate su questo catalogo sono espresse in millimetri

All the measures in this catalogue are in millimetres

Toutes les mesures de ce catalogue sont en millimètres

Las cuotas de este catalogo son expresadas en milímetros

# ARTICOLI CONSIGLIATI

## ADVISED ARTICLES

## ARTICLES CONSEILLES

## HERRAMIENTAS ACONSEJADOS

	MATERIALI MATERIALS	MATÉRIAUX MATERIALES
<b>LEGNI NATURALI NATURAL WOOD BOIS NATUREL MADERAS</b>	<i>Legni teneri long. Soft wood along</i> <i>Legni teneri trasv. Soft wood across</i> <i>Legni duri long. Hard wood along</i> <i>Legni duri trasv. Hard wood across</i> <i>Legni esotici long. Exotic wood along</i> <i>Legni esotici trasv. Exotic wood across</i> <i>Impiallacciati long. Veneers along</i> <i>Impiallacciati trasv. Veneers across</i>	<i>Bois tendres en long Maderas blan. longitudinal</i> <i>Bois tendres en travers Maderas blan. transversal</i> <i>Bois durs en long Maderas duras longitudinal</i> <i>Bois durs en travers Maderas duras transversal</i> <i>Bois exotiques en long Maderas exòt. longitudinal</i> <i>Bois exotiques en travers Maderas exòt. transversal</i> <i>Placages en long Chappas finas longitudinal</i> <i>Placages en travers Chappas finas transversal</i>
<b>LEGNI PRESSATI TREATED WOOD BOIS AMELIORES MADERAS AMEJORADOS</b>	<i>Compensati Plywood</i> <i>Compresso (truciolari) Compressed wood</i>	<i>Bois contre-plaquès Contrachapados</i> <i>Bois comprimès Madera prensada</i>
<b>PANNELLI BOARD MATERIALS PANNEAUX TABLEROS</b>	<i>Listellari Blockboard</i> <i>Impiallacciati Board veneered on both sides</i> <i>Fibra dura Hard board</i> <i>Fibra tenera Medium density board</i> <i>Rivestimento plastico Plastic laminated chipboard</i> <i>Rivestimento plastico High pressure laminate chipboard</i>	<i>Panneaux lattes Tableros alistonados</i> <i>Panneaux plaquès 2 faces Tableros rechapados en ambas caras</i> <i>Panneaux-fibres durs Tableros de fibras</i> <i>Panneaux-fibres tendres Tableros blandos</i> <i>Panneaux Lamifiès Tableros aglomerados con estratificado</i> <i>Panneaux de particules stratifiès Tableros aglomerados con melamin</i>
<b>PANNELLI PLASTICI PLASTICS MATÉRIAUX PLASTIQUES PLASTICOS</b>	<i>Termoplastici Solid thermoplastics</i> <i>Duroplastici Solid duroplastics</i> <i>Con legante in plastica Concrete bonded chipboard</i>	<i>Panneaux massifs thermoplastiques Tableros termoplàsticos</i> <i>Panneaux massifs duroplastiques Tableros estratificados</i> <i>Panneaux de particules à l'ant de ciment Tableros aglomerados a basa de cemento</i>
<b>METALLI NON FERROSI NON-FERROUS METALS MÉTAUX NON FERREUX METALES NO FERREOS</b>	<i>Profilati di alluminio Aluminium sections</i> <i>Alluminio Aluminium</i> <i>Leghe di alluminio Aluminium alloys</i>	<i>Profilés d'aluminium Perfilados de aluminio</i> <i>Alluminio Aluminio</i> <i>Alliages de aluminium Alliages aluminio</i>
<b>METALLI FERROSI FERROUS METALS MÉTAUX FERREUX METALES FERREOS</b>	<i>Profilati Profil</i> <i>Pieni Full</i> <i>Inox Inox</i>	<i>Profilés Perfilados</i> <i>Plein Lleno</i> <i>Inox Inox</i>

● Possibile / Possible / Possible / Possible

●● Buono / Good / Bon / Bueno

●●● Ottimo / Excellent / Excellent / Optimo





# ARTICOLI CONSIGLIATI

## ADVISED ARTICLES

## ARTICLES CONSEILLES

## HERRAMIENTAS ACONSEJADOS

	MATERIALI MATERIALS	MATÉRIAUX MATERIALES
<b>LEGNI NATURALI NATURAL WOOD BOIS NATUREL MADERAS</b>	<i>Legni teneri long. Soft wood along</i> <i>Legni teneri trasv. Soft wood across</i> <i>Legni duri long. Hard wood along</i> <i>Legni duri trasv. Hard wood across</i> <i>Legni esotici long. Exotic wood along</i> <i>Legni esotici trasv. Exotic wood across</i> <i>Impiallacciati long. Veneers along</i> <i>Impiallacciati trasv. Veneers across</i>	<i>Bois tendres en long Maderas blan. longitudinal</i> <i>Bois tendres en travers Maderas blan. transversal</i> <i>Bois durs en long Maderas duras longitudinal</i> <i>Bois durs en travers Maderas duras transversal</i> <i>Bois exotiques en long Maderas exòt. longitudinal</i> <i>Bois exotiques en travers Maderas exòt. transversal</i> <i>Placages en long Chappas finas longitudinal</i> <i>Placages en travers Chappas finas transversal</i>
<b>LEGNI PRESSATI TREATED WOOD BOIS AMELIORES MADERAS AMEJORADOS</b>	<i>Compensati Plywood</i> <i>Compresso (truciolari) Compressed wood</i>	<i>Bois contre-plaquès Contrachapados</i> <i>Bois comprimès Madera prensada</i>
<b>PANNELLI BOARD MATERIALS PANNEAUX TABLEROS</b>	<i>Listellari Blockboard</i> <i>Impiallacciati Board veneered on both sides</i> <i>Fibra dura Hard board</i> <i>Fibra tenera Medium density board</i> <i>Rivestimento plastico Plastic laminated chipboard</i> <i>Rivestimento plastico High pressure laminate chipboard</i>	<i>Panneaux lattes Tableros alistonados</i> <i>Panneaux plaquès 2 faces Tableros rechapados en ambas caras</i> <i>Panneaux-fibres durs Tableros de fibras</i> <i>Panneaux-fibres tendres Tableros blandos</i> <i>Panneaux Lamifiès Tableros aglomerados con estratificado</i> <i>Panneaux de particules stratifiès Tableros aglomerados con melamin</i>
<b>PANNELLI PLASTICI PLASTICS MATÉRIAUX PLASTIQUES PLASTICOS</b>	<i>Termoplastici Solid thermoplastics</i> <i>Duroplastici Solid duroplastics</i> <i>Con legante in plastica Concrete bonded chipboard</i>	<i>Panneaux massifs thermoplastiques Tableros termoplàsticos</i> <i>Panneaux massifs duroplastiques Tableros estratificados</i> <i>Panneaux de particules à l'ant de ciment Tableros aglomerados a basa de cemento</i>
<b>METALLI NON FERROSI NON-FERROUS METALS MÉTAUX NON FERREUX METALES NO FERREOS</b>	<i>Profilati di alluminio Aluminium sections</i> <i>Alluminio Aluminium</i> <i>Leghe di alluminio Aluminium alloys</i>	<i>Profilés d'aluminium Perfilados de aluminio</i> <i>Alluminio Aluminio</i> <i>Alliages de aluminium Alliages aluminio</i>
<b>METALLI FERROSI FERROUS METALS MÉTAUX FERREUX METALES FERREOS</b>	<i>Profilati Profil</i> <i>Pieni Full</i> <i>Inox Inox</i>	<i>Profilés Perfilados</i> <i>Plein Lleno</i> <i>Inox Inox</i>

● Possibile / Possible / Possible / Possible

●● Buono / Good / Bon / Bueno

●●● Ottimo / Excellent / Excellent / Optimo



PER OGNI LAMA CIRCOLARE ED OGNI  
APPLICAZIONE UNA SPECIFICA SILENZIATURA

FOR EACH CIRCULAR SAW BLADE AND  
EACH APPLICATION SPECIFIC NOISELESS

POUR CHAQUE LAME CIRCULAIRE ET CHAQUE  
APPLICATION UN TAILLAGE SILENCIEUX SPÉCIFIQUE

PARA CADA HOJA DE SIERRA Y CADA APLICACIÓN  
UN CORTE PARA SIERRA SILENCIOSA PARTICULAR

## LAME CIRCOLARI ECO-SIL GDA

### GDA ECO-SIL CIRCULAR SAW BLADES

### SCIES CIRCULAIRES GDA ECO-SIL

### HOJAS CIRCULARES ECO-SIL GDA

Una serie di intagli con una particolare geometria contribuisce a ridurre il rumore.

Su ogni diametro di lama circolare la posizione è diversa in modo da non influenzare la tensionatura; questi intagli laser non riempiti sono il sistema più economico per diminuire il normale rumore durante il taglio. Particolarmente adatti su lame universali per tagli trasversali e longitudinali.

Sul catalogo sono identificate dal simbolo  posto vicino al numero di denti "Z".

A series of grooves with a particular geometry help to reduce noise; on each diameter of circular saw blades the position of the grooves is different, in this way they don't ruin the tension.

These laser grooves are the cheapest system to decrease noise during normal cutting. Particularly suitable for universal saw blades for transverse and longitudinal cutting.

On the catalogue are identified by the symbol  placed near the number of teeth "Z".

Une série de taillages avec une géométrie particulière contribue à diminuer le bruit.

Sur chaque diamètre de la lame circulaire, la position est différente pour ne pas influencer la tension ; ces taillages en laser et pas remplis sont la façon plus économique pour réduire le bruit, qui normalement se produit pendant le débit. Particulièrement indiqués sur les lames universelles pour les débits transversaux et longitudinaux.

Dans le catalogue elles sont identifiés par le symbole  placé à côté du nombre des dents « Z ».

Una serie de cortes con una geometría particular contribuye a reducir el ruido.

Sobre cada diámetro de hojas de sierra, la posición es diferente para no influir sobre la tensión; estos cortes en láser y no llenados son el modo más económico para reducir el ruido, que normalmente se produce durante el corte. Particularmente indicados sobre las hojas de sierra para los cortes transversales y longitudinales.

En el catálogo se identifican por el símbolo  colocados al lado del número de dientes "Z".

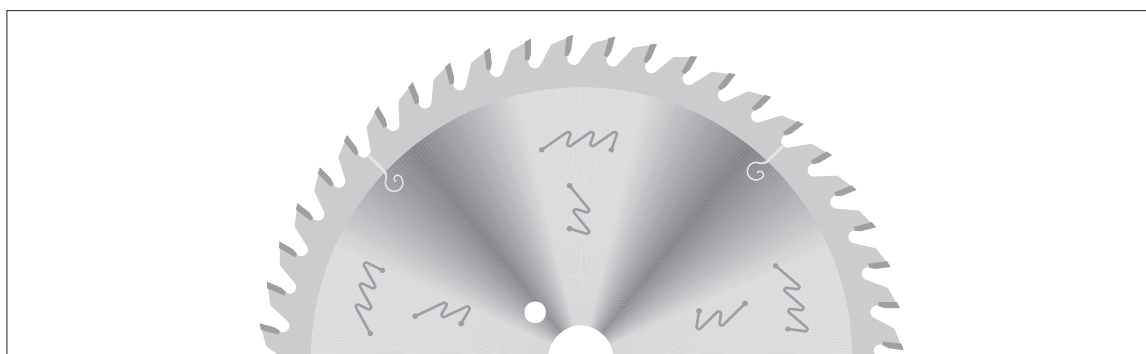

PER OGNI LAMA CIRCOLARE ED OGNI  
APPLICAZIONE UNA SPECIFICA SILENZIATURA

FOR EACH CIRCULAR SAW BLADE AND  
EACH APPLICATION SPECIFIC NOISELESS

POUR CHAQUE LAME CIRCULAIRE ET CHAQUE  
APPLICATION UN TAILLAGE SILENCIEUX SPÉCIFIQUE

PARA CADA HOJA DE SIERRA Y CADA APLICACIÓN  
UN CORTE PARA SIERRA SILENCIOSA PARTICULAR

## LAME CIRCOLARI SIL (BLACK SILENT) GDA

**GDA SIL (BLACK SILENT) CIRCULAR SAW BLADES**  
**SCIES CIRCULAIRES GDA SIL (BLACK SILENT)**  
**HOJAS CIRCULARES SIL (BLACK SILENT) GDA**

Uno speciale materiale fonoassorbente viene inserito all'interno di specifici intagli messi in posizioni particolari e diverse per ogni diametro di lama circolare. Tagli di dimensione non troppo grande e particolare forma sono stati studiati per lame da sezionatura, dove la robustezza del corpo sottoposto a grandi sforzi non deve essere compromessa.

Con questa soluzione assorbiamo il rumore e le vibrazioni e rendiamo unica la qualità di taglio e la durata della lama BLACK SILENT GDA da sezionatura.

Concetto simile ma geometria diversa per le lame da alluminio, anche qui uno speciale disegno è stato studiato per esaltare al massimo la prestazione di questa tipologia di lama. La speciale resina BLACK SILENT è resistente agli ultrasuoni e alle temperature elevate, quindi anche dopo numerose riaffilature l'efficienza del trattamento è garantita.

Sul catalogo sono identificate dal simbolo  posto vicino al numero di denti "Z".

Special sound-absorbing material is placed in specific laser grooves placed in special positions and different for each diameter of circular saw blade. Size of laser cuts not too big, and special shape were studied for circular saw blades for panel, where the strength of the body subjected to great efforts must not be compromised.

With this solution the noise and vibration are absorbed and obtained cutting quality and the duration of the circular saw blade BLACK SILENT GDA for panel are unique.

Similar concept but different geometry for aluminium circular saw blades, again a special cut was designed to bring out the best performance of this type of blade. The BLACK SILENT special resin is resistant to ultrasonic and high temperatures, so even after several regrinding the treatment efficiency is guaranteed.

On the catalogue are identified by the symbol  placed next to the number of teeth "Z".

Un matériel spécial insonorisant est inséré dans des taillages spécifiques placés en positions particulières et différentes pour chaque diamètre de lame circulaire. Des taillages de dimension pas trop grand et faits en forme particulière sont états étudiés pour les lames pour le débit de panneaux, où la robustesse du corps, soumis à des grands efforts, ne doit pas être compromise.

Avec cette solution, le bruit et la vibration sont absorbés et nous rendons unique la qualité du débit et la durée des lames BLACK SILENT GDA pour le débit de panneaux.

Le concept est le même, mais la géométrie est différente, pour les lames pour l'acier, ici aussi un dessin spécial a été étudié pour améliorer au maximum la prestation de cette typologie de lame. La résine spéciale BLACK SILENT est résistante aux ultrasons et aux hautes températures ; donc, même après beaucoup d'affûtages, l'efficiencia du traitement est garantie.

Dans le catalogue elles sont identifiées par le symbole  placé à côté du nombre des dents « Z ».

Un material especial que insonoriza es insertado en cortes específicos colocados en posiciones particulares y diferentes para cada diámetro de hoja de sierra. Cortes de dimensión no más grande y en forma particular son estados estudiado para la hoja para el despiezado de tableros, donde la robustez del cuerpo, sometido a grandes esfuerzos, no debe ser comprometida.

Con esta solución, el ruido y la vibración son absorbidos y hacemos única la calidad del corte y la duración de la hoja BLACK SILENT GDA para el despiezado de tableros.

El concepto es lo mismo, pero la geometría es diferente, para las hojas para el acero, aquí también un dibujo especial fue estudiado para mejorar como máximo la prestación de esta tipología de hoja. La resina especial BLACK SILENT es resistente a los ultrasonidos y a las temperaturas altas; pues, hasta después de muchas afiladuras, la eficiencia del tratamiento es garantizada.

En el catálogo se identifican por el símbolo  colocados al lado del número de dientes "Z".

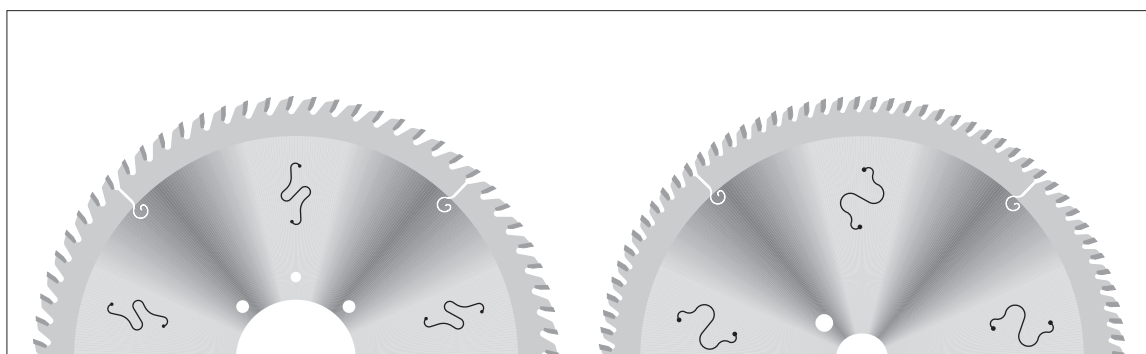

PER OGNI LAMA CIRCOLARE ED OGNI  
APPLICAZIONE UNA SPECIFICA SILENZIATURA

FOR EACH CIRCULAR SAW BLADE AND  
EACH APPLICATION SPECIFIC NOISELESS

POUR CHAQUE LAME CIRCULAIRE ET CHAQUE  
APPLICATION UN TAILLAGE SILENCIEUX SPÉCIFIQUE

PARA CADA HOJA DE SIERRA Y CADA APLICACIÓN  
UN CORTE PARA SIERRA SILENCIOSA PARTICULAR

## LAME CIRCOLARI ULTRA-SIL GDA

**GDA ULTRA-SIL CIRCULAR SAW BLADES**  
**SCIES CIRCULAIRES GDA ULTRA-SIL**  
**HOJAS CIRCULARES ULTRA-SIL GDA**

Dove è richiesto il massimo abbattimento possibile del rumore, adatta su qualsiasi tipo di lama in particolare per universali su taglio trasverso e lungo vena.

La superiorità delle lame silenziate GDA nasce da una serie di studi e dall'impegno di nuove tecnologie; infatti grazie alla oculata posizione dei tagli "silenzianti", alla loro forma, dimensione, numero, ma soprattutto al materiale fono-assorbente inserito, si ottengono degli ottimi risultati.

Gli speciali "silenzianti" GDA permettono di assorbire sia longitudinalmente che trasversalmente le "onde sonore" che si generano durante il taglio.

Numerosi sono perciò i vantaggi:

- assenza di vibrazioni
- miglior finitura di taglio
- rumorosità notevolmente ridotta

Sul catalogo sono identificate dal simbolo  posto vicino al numero di denti "Z".

The superiority of the GDA low-noise saw blades results from a series of studies and from the use of new technologies; in fact, thanks to the ingenious position of our "silent cuts", to their form, dimension, number and most of all to the noise absorbing material inside, you can obtain very good results.

The special GDA "silent cuts" enable the absorption of the "sound-waves" that are produced during the cutting both longitudinally and transversally.

Therefore there are many advantages:

- absence of vibration
- better finished cut
- noise level drastically reduced

In the catalog are identified by the symbol  placed next to the number of teeth "Z".

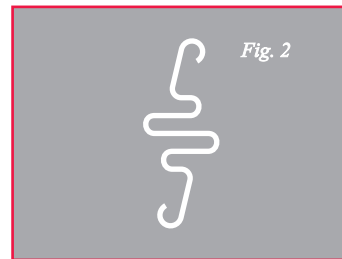
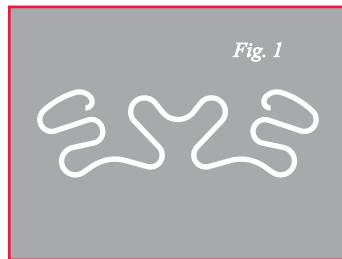

La supériorité des lames silencieuses GDA est née depuis longues études et avec l'emploi des nouvelles technologies : en effet, grâce à la position des coups "silencieux", à leur forme, dimension, numéro, mais surtout au matériel insonorisant inséré, nous pouvons obtenir des excellents résultats.

Les spéciaux "silencieux" GDA nous permettent d'absorber soit longitudinalement que transversalement les ondes sonores que naissent pendant le découpage.

Les avantages sont nombreux :

- absence des vibrations
- meilleure finition de découpage
- bruit extrêmement réduit

Dans le catalogue sont identifiés par le symbole  placé à côté du nombre de dents "Z".

La superioridad de las hojas silenciadas GDA nace de una serie de estudios y del uso de nuevas tecnologías; por lo tanto, gracias a la atenta posición de los cortes "silenciadores", a las formas, dimensiones, número y sobretodo al material, fono - absorbente incluido, se logran óptimos resultados.

Los especiales "silenciadores" GDA permiten de absorber sea longitudinalmente que transversalmente las "ondas sonoras" que se generan durante el corte.

Numerosas son las ventajas:

- ausencia de vibraciones
- mejor ejecución de corte
- rumor notablemente reducido

En el catálogo se identifican por el símbolo  colocados al lado del número de dientes "Z".

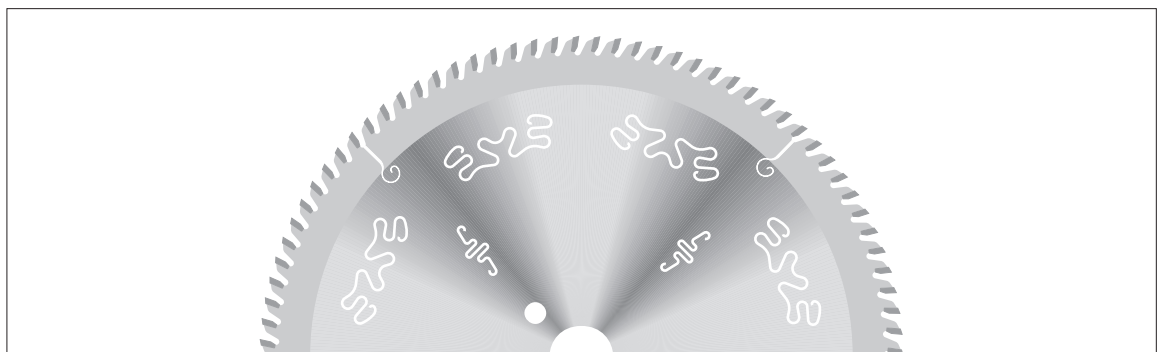

# NUOVO RIVESTIMENTO "GDA - COATED"

## NEW SAW BLADE "GDA - COATED" NOUVEAU REVETEMENT "GDA - COATED" NUEVO REVESTIMIENTO "GDA - COATED"

La ditta G.D.A. nel suo programma di ricerca e sviluppo ha creato una nuova tipologia di lame denominate "GDA COATED". Dette lame hanno la particolarità di non essere soggette alla corrosione e alla ruggine, di essere antiaderenti, di avere minore attrito durante la lavorazione, di ridurre notevolmente la temperatura del corpo lama durante il taglio, di diminuire l'assorbimento di corrente elettrica e sono perciò particolarmente indicate in tutte quelle situazioni ove c'è un'alta percentuale di umidità, all'aria aperta (cantieri edili), nelle segherie, dove si lavora con materiale bagnato, molto umido o con tendenza ad incrostare (plastiche, gomme etc.), dove sono presenti resina o colle e dove è richiesto minor attrito (tagli sottili).

L'eccezionalità delle lame "GDA COATED" consiste nel fatto che il corpo della lama, anche nelle lavorazioni più difficili, tende a rimanere sempre pulito e diritto, quindi l'utensile risulterà sempre perfettamente efficiente.

Tutte le lame del presente catalogo possono essere richieste con tipologia "GDA COATED".

**La funzionalità del sistema "GDA COATED" è garantita per tutta la durata della lama.**

La G.D.A. pendant le programme de recherche et développement a créé une nouvelle typologie de lames appelées "GDA COATED". Pour leur propriétés de ne subir pas de corrosion et de rouille, d'être anti-adhérent, de ne produire pas de frottement, de réduire considérablement la température du corps de la lame pendant le travail et de réduire l'absorption d'électricité ces lames sont particulièrement indiquées pour toutes les situations où il y a une haute pourcentage de humidité, à l'air ouverte (chantiers de constructions), dans les scieries, avec le matériel mouillé, très humide au avec la tendance à incruster (plastique et gomme), où il y a résine et colle, et où c'est nécessaire un moindre frottement (coupes fines).

L'exceptionnalité de la lame "GDA COATED" est le fait que le corps de la lame tend à rester net et droit aussi pendant le travail plus difficile, donc l'outil sera toujours parfaitement efficient.

Toutes les lames de ce catalogue peuvent être demandées avec la typologie "GDA COATED".

**La fonctionnalité du système "GDA COATED" est garantie pour toute la vie de la lame.**

During his program of research and development, the GDA company has built a new kind of saw blades called "GDA COATED". These saws don't suffer the corrosion and the rust, they're not sticking, they produce less friction during the use, they reduce the temperature of the body of the saw blade during the cut, they reduce the absorption of electricity and so, they're particularly indicated for all the situations where there is an high percentage of humidity, at the open air (building sites), in the saw-mills, when it's necessary working with wet material or with material very humid or with tendency to encrust (plastic and rubber etc.), where there are resin or glue, and where it's necessary less friction (thin cut).

The exceptionality of the saw "GDA COATED" is that the body remains cleaned and straight even during difficult working and so the tool will be always very efficient.

All the saw blades in this catalogue could be ordered with the typology "GDA COATED".

**The functionality of the system "GDA COATED" is guaranteed for all the life of the saw.**

La empresa G.D.A. en su programa de búsqueda y desarrollo ha creado una nueva tipología de hojas llamadas "GDA COATED". Dichas hojas tienen la particularidad de no ser sujetas a la corrosión ni al herrumbre, de ser anti-adherente, de tener menor frotamiento durante la elaboración, de reducir notablemente la temperatura del cuerpo de la hoja durante el corte, de disminuir el consumo de corriente eléctrica y son por lo tanto particularmente indicadas en todas aquellas situaciones donde hay un alto porcentaje de humedad, al aire abierto (barraca de la edificación), en los aserraderos, donde se trabaja con material bañado, muy húmedo o con tendencia a incrustaciones (plástico, gomas, etc) donde se presentan resinas o colas y donde se pide menor frotamiento (cortes finos).

La excepcionalidad de las hojas "GDA COATED" consiste en el hecho que el cuerpo de la hoja, también en las elaboraciones más difíciles tiende a quedarse siempre limpio y derecho, por lo tanto, los utensilios resultan siempre perfectamente eficaces.

Todas las hojas del presente catalogo pueden ser pedidas con tipología "GDA COATED".

**La funcionalidad del sistema "GDA COATED" es garantizada por toda la duración de la hoja.**



# SISTEMA DI FISSAGGIO HYDRO

## HYDRO CLAMPING SYSTEM LE SYSTEM DE FIXAGE HYDRO SISTEMA DE FIJACION HYDRO

Il sistema Hydro consiste in due manicotti d'acciaio tra i quali c'è uno strato di grasso che trasmette la pressione e li fa espandere verso l'albero e l'utensile, eliminando errori di centratura.

In the Hydro system a layer of grease between two hardened steel sleeves transmits the pressure and permits their expansion towards the spindle and the tool so the error of centring is eliminated.

Le system Hydro est composé par deux manchons en acier entre lesquels il y a une couche de graisse qui transmette la pression et permette leur expansion vers l'arbre et l'outil éliminant ainsi les erreurs de centrage.

El sistema Hydro consiste en dos manguitos de acero entre los cuales hay un estrato de grasa que transmite la presión y lo hace derramar hacia el árbol de ceva y al utensilio, eliminando errores de centrado.



TIPO	d	D1	L	L1	L2	KG	COD
B-35/60-75	35	60	75	40	55	1,9	AH3575
B-35/60-115	35	60	115	80	95	2,5	AH35115
B-35/60-140	35	60	140	105	120	2,8	AH35140
B-35/60-165	35	60	165	130	145	3,0	AH35165
B-40/60-75	40	60	75	40	55	1,7	AH4075
B-40/60-115	40	60	115	80	95	2,2	AH40115
B-40/60-140	40	60	140	105	120	2,5	AH40140
B-40/60-165	40	60	165	130	145	2,8	AH40165
B-40/60-215	40	60	215	180	195	3,4	AH40215
B-50/60-75	50	60	75	40	55	1,3	AH5075
B-50/60-95	50	60	95	60	75	1,4	AH5095
B-50/60-115	50	60	115	80	95	1,6	AH50115
B-50/60-140	50	60	140	105	120	1,7	AH50140
B-50/60-190	50	60	190	155	170	2,1	AH50190
B-50/60-230	50	60	230	195	210	2,4	AH50230
B-50/60-240	50	60	240	205	220	2,5	AH50240

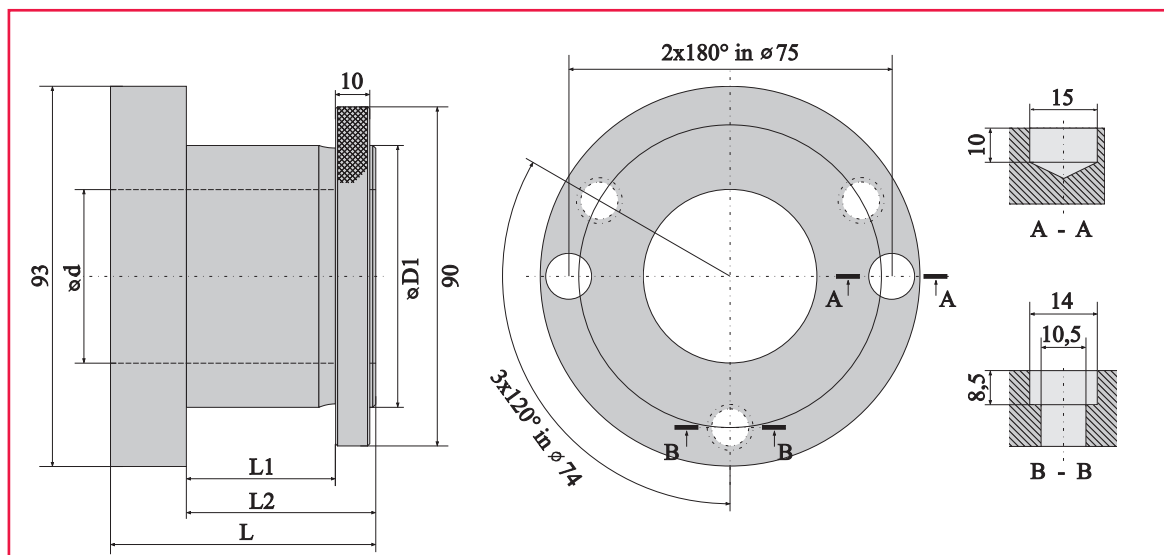

# LAMA CIRCOLARE UNIVERSALE

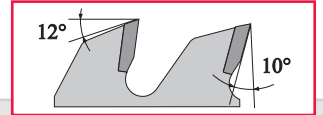
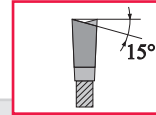

**GB** Universal circular saw blade

**F** Scie circulaire universelle

**E** Hoja de sierra para empleo universal

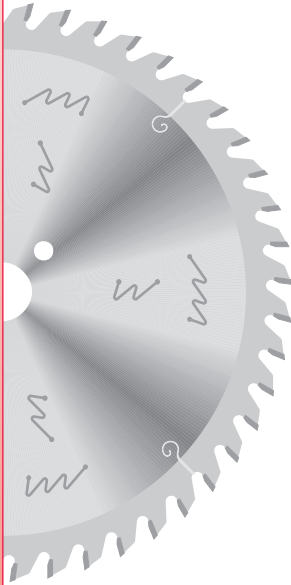

	D	B	b	d	●●●	Z	COD	€
○	100	3,2	2,2	20		20	LU100322020	34,00
○	120	3,2	2,2	20		20	LU120322020	34,20
○	125	3,2	2,2	20		24	LU125322024	35,00
○	140	3,2	2,2	30		24	LU140323024	37,00
○	150	3,2	2,2	30		24	LU150323024	37,00
○	160	3,2	2,2	30		24	LU160323024	39,80
○	180	3,2	2,2	30		30	LU180323030	42,00
○	200	3,2	2,2	30		34	LU200323034	42,70
○	220	3,2	2,2	30		34	LU220323034	50,00
○	225	3,2	2,2	30		36	LU225323036	51,00
○	250	3,2	2,2	30	PH2	40	LU2503230F40	38,00
○	275	3,2	2,2	30	PH2	44	LU2753230F44	72,00
○	280	3,2	2,2	30	PH2	48	LU2803230F48	57,50
○	300	3,2	2,2	30	PH2	48	LU3003230F48	48,60
□	330	3,2	2,2	30	PH2	52	LU3303230F52	86,00
○	350	3,5	2,5	30	PH2	54	LU3503530F54	60,00
○	400	4,0	2,8	30	PH2	60	LU4004030F60	87,20
○	450	4,2	2,8	30	2/10/60	66	LU4504230F66	105,80
△	450	4,2	2,8	35		66	LU450423566	125,80
○	450	4,2	2,8	30	2/10/60	72	LU4504230F72	112,00
△	450	4,2	2,8	35		72	LU450423572	132,00
○	500	4,2	2,8	30	2/10/60	72	LU5004230F72	128,60
△	500	4,2	2,8	35		72	LU500423572	148,60
○	550	5,2	3,6	30	2/10/60	80	LU5505230F80	205,00
○	550	5,2	3,6	35		80	LU550523580	205,00
○	600	5,2	3,6	30	2/10/60	80	LU6005230F80	238,00
○	600	5,2	3,6	35		80	LU600523580	238,00
□	650	6,2	4,0	35		84	LU650623584	390,00
○	700	6,2	4,0	40		84	LU700624084	428,00
○	700	6,2	4,0	80		84	LU700628084	428,00



IM

104

GDA High-tech tools

# LAMA CIRCOLARE UNIVERSALE

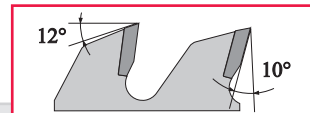
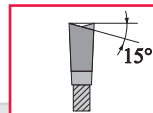

**(GB)** Universal circular saw blade

**(F)** Scie circulaire universelle

**(E)** Hoja de sierra para empleo universal

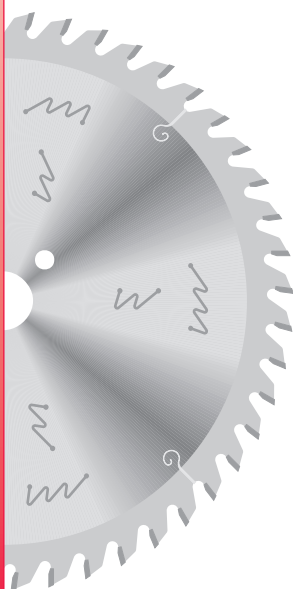

	D	B	b	d	●●●	Z	COD	€
○	140	3,2	2,2	30		32	LU140323032	42,50
□	150	3,2	2,2	30		30	LU150323030	40,50
○	160	3,2	2,2	30		36	LU160323036	42,00
○	170	3,2	2,2	30		36	LU170323036	42,60
○	180	3,2	2,2	30		36	LU180323036	43,00
○	200	3,2	2,2	30		42	LU200323042	46,50
○	250	3,2	2,2	30	PH2	48	LU2503230F48	40,00
○	300	3,2	2,2	30	PH2	60	LU3003230F60	55,90
○	350	3,5	2,5	30	PH2	72	LU3503530F72	70,10
○	400	4,0	2,8	30	PH2	80	LU4004030F80	97,10
○	450	4,2	2,8	30	2/10/60	88	LU4504230F88	148,00
△	450	4,2	2,8	35		88	LU450423588	168,00
○	500	4,2	3,0	30	2/10/60	96	LU5004230F96	190,00
△	500	4,2	3,0	35		96	LU500423596	210,00
△	550	5,2	3,6	30	2/10/60	96	LU5505230F96	242,00
△	550	5,2	3,6	35		96	LU550523596	242,00
△	600	5,2	3,6	30	2/10/60	96	LU6005230F96	308,00
△	600	5,2	3,6	35		96	LU600523596	308,00
△	700	6,2	4,0	40		120	LU7006240120	480,00

IM

106

GDA High-tech tools

# LAMA CIRCOLARE UNIVERSALE

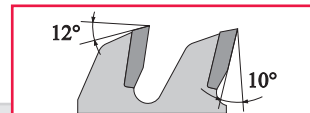
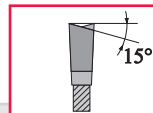

**(GB)** Universal circular saw blade

**(F)** Scie circulaire universelle

**(E)** Hoja de sierra para empleo universal

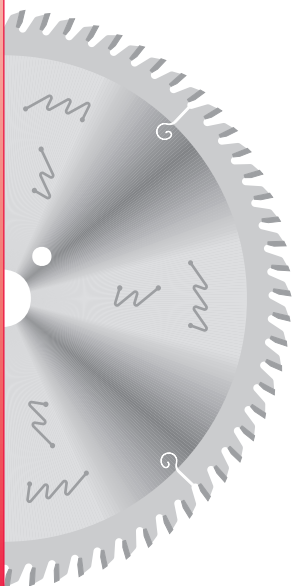

	D	B	b	d	●●●	Z	COD	€
△	120	3,2	2,2	30		30	LU120323030	39,40
△	125	3,2	2,2	30		30	LU125323030	39,50
○	150	3,2	2,2	30		36	LU150323036	40,50
○	180	3,2	2,2	30		48	LU180323048	52,50
○	200	3,2	2,2	30		48	LU200323048	52,80
○	220	3,2	2,2	30		48	LU220323048	54,00
○	250	3,2	2,2	30	PH2	60	LU2503230F60	42,90
△	275	3,2	2,2	30	PH2	68	LU2753230F68	82,00
○	300	3,2	2,2	30	PH2	72	LU3003230F72	57,20
□	330	3,2	2,2	30	PH2	72	LU3303230F72	98,50
○	350	3,5	2,5	30	PH2	84	LU3503530F84	73,00
○	400	4,0	2,8	30	PH2	96	LU4004030F96	108,60
○	450	4,2	2,8	30	2/10/60	108	LU4504230F108	144,00
△	450	4,2	2,8	35		108	LU4504235108	164,00
○	500	4,2	3,0	30	2/10/60	120	LU5004230F120	200,00
△	500	4,2	3,0	35		120	LU5004235120	220,00

○ △ □ \* ⓧ Ⓣ Ⓤ = vedi pagina 6 / see page 6 / voir page 6 / vease pagina 6

I  
M

1  
0  
8

# LAMA CIRCOLARE AD ALTO RENDIMENTO

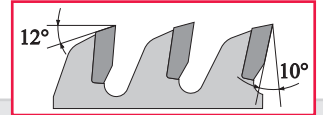
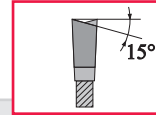

**GB** High - efficiency circular saw blade

**F** Scie circulaire avec haut rendement

**E** Hoja de sierra de alto rendimiento

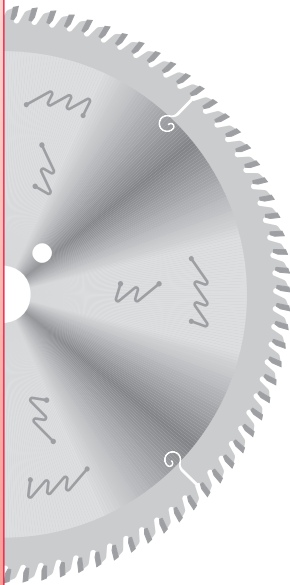

	D	B	b	d	●●●	Z	COD	€
□	100	3,2	2,2	30		30	LU100323030	45,00
△	120	3,2	2,2	30		36	LU120323036	46,20
△	125	3,2	2,2	30		40	LU125323040	46,50
○	150	3,2	2,2	30		48	LU150323048	46,80
○	160	3,2	2,2	30		48	LU160323048	50,20
○	180	3,2	2,2	30		56	LU180323056	55,20
○	200	3,2	2,2	30		64	LU200323064	58,60
○	220	3,2	2,2	30	PH2	64	LU2203230F64	60,80
□	225	3,2	2,2	30		72	LU225323072	79,50
○	250	3,2	2,2	30	PH2	80	LU2503230F80	57,20
△	275	3,2	2,2	30	PH2	88	LU2753230F88	95,00
○	300	3,2	2,2	30	PH2	96	LU3003230F96	71,50
□	320	3,2	2,2	30	PH2	96	LU3203230F96	122,00
△	330	3,2	2,2	20		96	LU330322096	114,50
△	330	3,2	2,2	30	PH2	96	LU3303230F96	114,50
○	350	3,5	2,5	30	PH2	108	LU3503530F108	88,60
○	400	4,0	2,8	30	PH2	120	LU4004030F120	121,60
○	450	4,2	3,0	30	2/10/60	132	LU4504230F132	180,00
△	450	4,2	3,0	35		132	LU4504235132	200,00
○	500	4,2	3,0	30	2/10/60	144	LU5004230F144	232,00
△	500	4,2	3,0	35		144	LU5004235144	252,00

I  
M

1  
1  
0

GDA  
High-tech tools

## LAMA CIRCOLARE PER TAGLI LONGITUDINALI

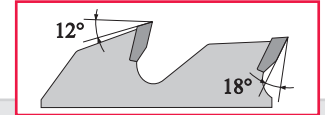
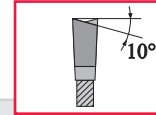

**(GB)** Lengthwise cutting circular saw blade

**(F)** Scie circulaire pour coupes longitudinales

**(E)** Hoja de sierra para empleo cortes longitudinales

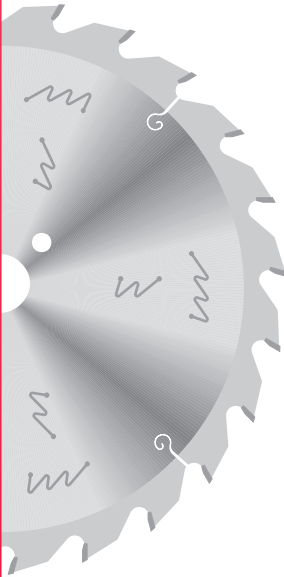

	D	B	b	d	●●●	Z	COD	€
□	200	3,2	2,2	30		16	LN200323016	40,20
○	250	3,2	2,2	30	PH2	20	LN2503230F20	41,30
□	275	3,2	2,2	30	PH2	20	LN2753230F20	57,00
○	300	3,2	2,2	30	PH2	24	LN3003230F24	41,50
○	350	3,5	2,5	30	PH2	28	LN3503530F28	55,80
○	400	4,0	2,8	30	PH2	32	LN4004030F32	67,20
○	450	4,2	2,8	30	2/10/60	36	LN4504230F36	91,50
△	450	4,2	2,8	35		36	LN450423536	111,50
○	500	4,2	2,8	30	2/10/60	40	LN5004230F40	98,70
△	500	4,2	2,8	35		40	LN500423540	118,70
○	550	5,2	3,6	30	2/10/60	44	LN5505230F44	180,00
△	550	5,2	3,6	35		44	LN550523544	180,00
○	600	5,2	3,6	30	2/10/60	48	LN6005230F48	215,00
△	600	5,2	3,6	35		48	LN600523548	215,00
□	650	6,2	4,0	35		48	LN650623548	372,00
△	700	6,2	4,0	30	2/10/60	48	LN7006230F48	398,00
△	700	6,2	4,0	40		48	LN700624048	398,00

## LAMA CIRCOLARE PER TAGLI TRASVERSALI

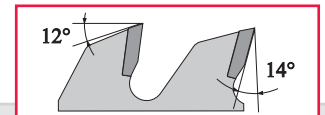
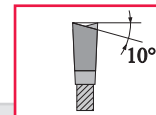

**(GB)** Transversal cutting circular saw blade

**(F)** Scie circulaire pour débits transversaux

**(E)** Hoja de sierra para cortes transversales

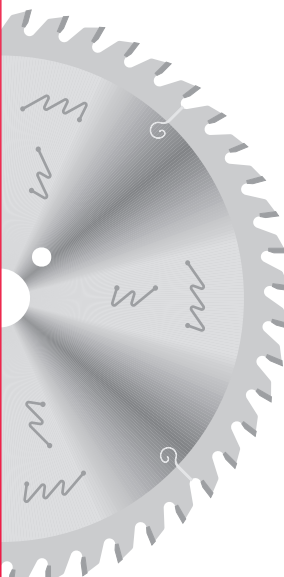

	D	B	b	d	●●●	Z	COD	€
□	150	3,2	2,2	30		18	LU150323018	38,50
○	180	3,2	2,2	30		24	LU180323024	40,90
○	200	3,2	2,2	30		24	LU200323024	41,50
○	210	3,2	2,2	30		24	LU210323024	46,50
○	220	3,2	2,2	30		24	LU220323024	46,50
○	250	3,2	2,2	30	PH2	30	LU2503230F30	48,50
□	275	3,2	2,2	30	PH2	32	LU2753230F32	61,40
○	300	3,2	2,2	30	PH2	36	LU3003230F36	50,80
□	330	3,2	2,2	30	PH2	40	LU3303230F40	76,50
○	350	3,5	2,5	30	PH2	42	LU3503530F42	64,20
○	400	4,0	2,8	30	PH2	48	LU4004030F48	81,50
○	450	4,2	2,8	30	2/10/60	54	LU4504230F54	102,90
△	450	4,2	2,8	35		54	LU450423554	122,90
○	500	4,2	2,8	30	2/10/60	60	LU5004230F60	122,90
△	500	4,2	2,8	35		60	LU500423560	142,90
○	550	5,2	3,6	30	2/10/60	60	LU5505230F60	196,00
○	550	5,2	3,6	35		60	LU550523560	196,00
○	600	5,2	3,6	30	2/10/60	60	LU6005230F60	228,00
○	600	5,2	3,6	35		60	LU600523560	228,00
□	650	6,2	4,0	35		64	LU650623564	398,00
△	700	6,2	4,0	30	2/10/60	64	LU7006230F64	419,00
△	700	6,2	4,0	40		64	LU700624064	419,00

GDA  
High-tech tools

○ △ □ \* Ⓢ Ⓣ Ⓤ = vedi pagina 6 / see page 6 / voir page 6 / vease pagina 6



# LAMA CIRCOLARE AD ALTO RENDIMENTO - HIGH LINE

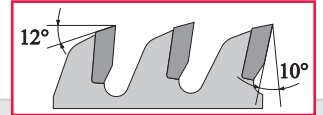
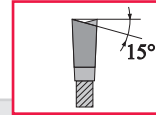

High-efficiency circular saw blade  
high line



Scie circulaire avec haut rendement  
high line



Hoja de sierra de alto rendimiento  
high line

I  
M

1  
1  
5

HIGH  
LINE

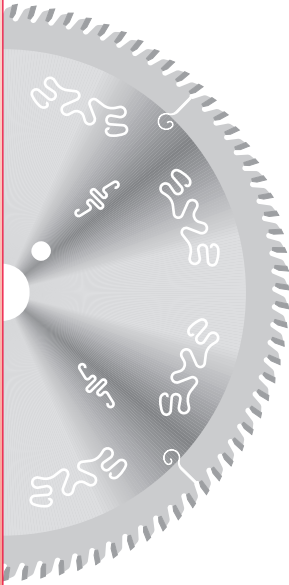

	D	B	b	d	●●●	Z	COD	€
○	250	3.2	2.2	30	PH2	40	LU2503230F40I	46.80
○	250	3.2	2.2	30	PH2	60	LU2503230F60I	53.90
○	250	3.2	2.2	30	PH2	80	LU2503230F80I	68.20
○	300	3.2	2.2	30	PH2	48	LU3003230F48I	61.60
○	300	3.2	2.2	30	PH2	60	LU3003230F60I	68.90
○	300	3.2	2.2	30	PH2	72	LU3003230F72I	70.20
○	300	3.2	2.2	30	PH2	96	LU3003230F96I	84.50
○	350	3.5	2.5	30	PH2	54	LU3503530F54I	76.00
○	350	3.5	2.5	30	PH2	72	LU3503530F72I	86.10
○	350	3.5	2.5	30	PH2	84	LU3503530F84I	89.00
○	350	3.5	2.5	30	PH2	108	LU3503530F108I	104.60
○	400	4.0	2.8	30	PH2	60	LU4004030F60I	87.20
○	400	4.0	2.8	30	PH2	80	LU4004030F80I	118.10
○	400	4.0	2.8	30	PH2	96	LU4004030F96I	108.60
○	400	4.0	2.8	30	PH2	120	LU4004030F120I	142.60

I  
M

1  
1  
6

GDA  
High-tech tools

## LAMA CIRCOLARE PER PANNELLI RIVESTITI

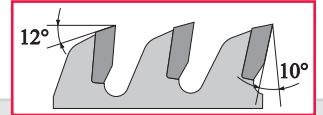
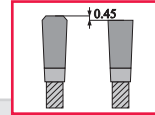

**(GB)** Circular saw blade for cutting plastic laminated panels

**(F)** Scie circulaire pour panneaux stratifiés

**(E)** Hoja de sierra para tableros estratificados

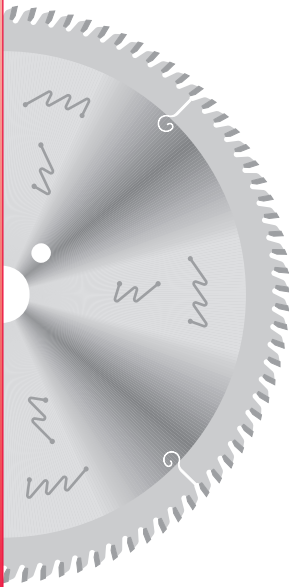

	D	B	b	d	●●●	Z	COD	€
○	200	3,2	2,2	30		64	LS200323064T	66,70
○	220	3,2	2,2	30	PH2	64	LS2203230F64T	66,70
○	250	3,2	2,2	30	PH2	60	LS2503230F60T	48,60
○	250	3,2	2,2	30	PH2	80	LS2503230F80T	60,00
○	300	3,2	2,2	30	PH2	72	LS3003230F72T	60,00
○	300	3,2	2,2	30	PH2	96	LS3003230F96T	73,00
□	320	3,2	2,2	30	PH2	72	LS3203230F72T	129,40
□	320	3,2	2,2	30	PH2	96	LS3203230F96T	144,80
○	350	3,5	2,5	30	PH2	84	LS3503530F84T	84,40
○	350	3,5	2,5	30	PH2	108	LS3503530F108T	91,50
□	400	4,0	2,8	30	PH2	120	LS4004030F120T	146,50
□	450	4,2	3,0	30	2/10/60	132	LS4504230F132T	212,00
□	450	4,2	3,0	35		132	LS4504235132T	232,00
□	500	4,2	3,0	30	2/10/60	144	LS5004230F144T	262,00
□	500	4,2	3,0	35		144	LS5004235144T	282,00

## LAMA CIRCOLARE CON TAGLIENTI CONCAVI

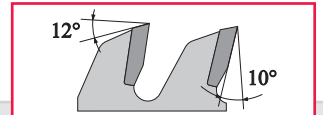
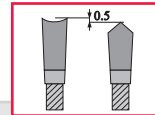

**(GB)** Circular saw blade with hollow / inverted - V tooth

**(F)** Scie circulaire avec denture concave

**(E)** Hoja de sierra con dientes concave

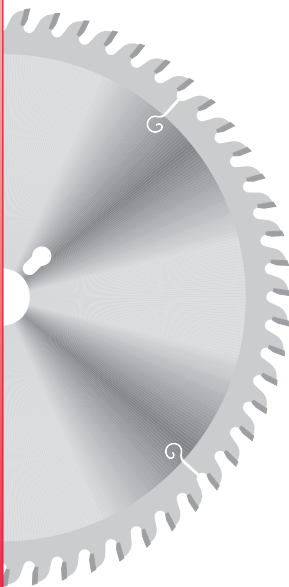

	D	B	b	d	●●●	Z	COD	€
○	220	3,2	2,2	30	PH2	42	LH2203230F42P	80,50
○	250	3,2	2,2	30	PH2	48	LH2503230F48P	81,90
○	300	3,2	2,2	30	PH2	60	LH3003230F60P	93,60
□	303	3,2	2,2	30	PH2	60	LH3033230F60P	104,80
○	350	3,5	2,5	30	PH2	72	LH3503530F72P	125,90

GDA  
High-tech tools

## LAMA CIRCOLARE PER PANNELLI RIVESTITI - HIGH LINE

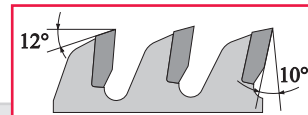
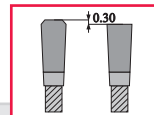

**(GB)** Circular saw blade for cutting plastic laminated panels high line

**(F)** Scie circulaire pour panneaux stratifiés high line

**(E)** Hoja de sierra para tableros estratificados high line

I  
M

1  
1  
8

HIGH  
LINE

GDA  
High-tech tools

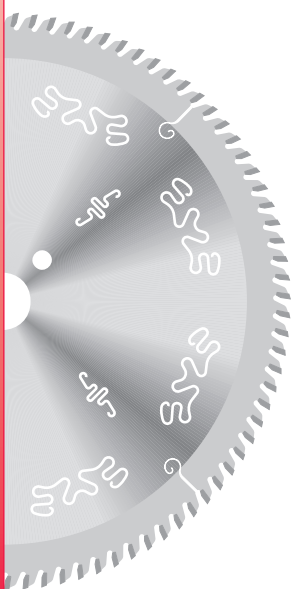

	D	B	b	d	●●●	Z	COD	€
○	250	3.2	2.2	30	PH2	60	LS2503230F60TI	59.60
○	250	3.2	2.2	30	PH2	80	LS2503230F80TI	71.00
○	300	3.2	2.2	30	PH2	72	LS3003230F72TI	73.00
○	300	3.2	2.2	30	PH2	96	LS3003230F96TI	86.00
○	350	3.5	2.5	30	PH2	84	LS3503530F84TI	100.40
○	350	3.5	2.5	30	PH2	108	LS3503530F108TI	107.50

## LAMA CIRCOLARE PER PANNELLI RIVESTITI - HIGH LINE

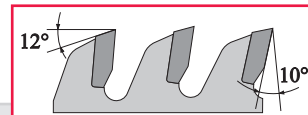
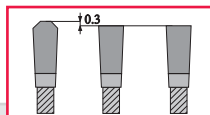

**(GB)** Circular saw blade for cutting plastic laminated panels high line

**(F)** Scie circulaire pour panneaux stratifiés high line

**(E)** Hoja de sierra para tableros estratificados high line

I  
M

1  
1  
9

HIGH  
LINE

GDA  
High-tech tools

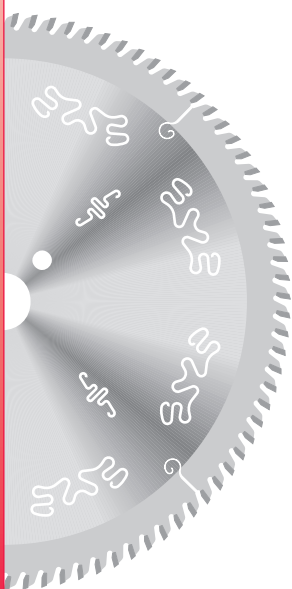

	D	B	b	d	●●●	Z	COD	€
□	250	3.2	2.2	30	PH2	78	LS2503230F78TFFI	74,50
□	300	3.2	2.2	30	PH2	96	LS3003230F96TFFI	90,30
□	350	3.5	2.5	30	PH2	108	LS3503530F108TFFI	112,90

OTTIMA FINITURA ANCHE SENZA INCISORE  
DURATA MAGGIORE DATA DALL'AFFILATURA TFF

EXCELLENT FINISHED CUT, WITHOUT SCORER TOO  
GREATER LIFETIME THANKS TO THE SHARPENING TFF

EXCELLENTE FINITION, MÊME SANS L'INCISEUR  
DURÉE PLUS GRANDE GRÂCE À L'AFFÛTAGE TFF

ÓPTIMO ACABADO TAMBIÉN SIN INCISOR  
MAYOR DURACIÓN GRACIAS A L'AFILADURA TFF

# LAMA CIRCOLARE PER PANNELLI RIVESTITI - HIGH LINE

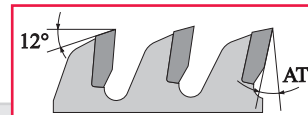
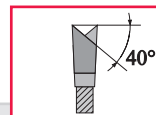

**GB** Circular saw blade for cutting plastic laminated panels high line

**F** Scie circulaire pour panneaux stratifiés high line

**E** Hoja de sierra para tableros estratificados high line

I  
M

1  
2  
0

HIGH  
LINE

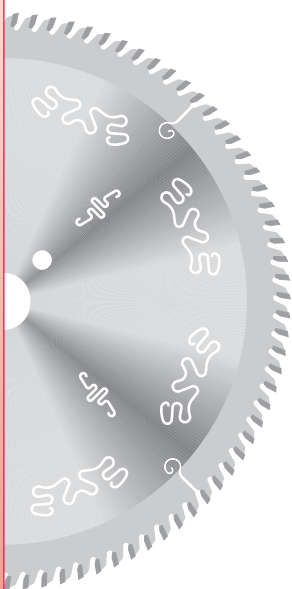

	D	B	b	d	●●●	Z	AT	COD	€
<input type="checkbox"/>	250	3.2	2.2	30	PH2	80	-2°	LS2503230F80GNI	74,50
<input type="checkbox"/>	300	3.2	2.2	30	PH2	96	2°	LS3003230F96GI	90,30
<input type="checkbox"/>	350	3.5	2.5	30	PH2	108	5°	LS3503530F108GI	112,90

OTTIMA FINITURA ANCHE SENZA INCISORE  
EXCELLENT FINISHED CUT, WITHOUT SCORER TOO  
EXCELLENTE FINITION, MÊME SANS L'INCISEUR  
ÓPTIMO ACABADO TAMBIÉN SIN INCISOR



I  
M

## LAMA CIRCOLARE PER TAGLI DI CORNICI

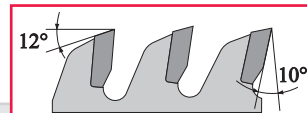
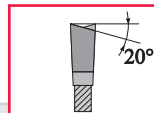
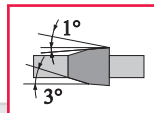

**(GB)** Circular saw blade for frames

**(F)** Scie circulaire pour cadres

**(E)** Hoja de sierra para molduras

1  
2  
1



	D	B	b	d	●●●	Z	COD	€
○	200	3,0	2,5	30		64	LQ200303064/C	82,00
△	250	3,0	2,5	30	PH2	60	LQ250303060/C	70,20
○	250	3,0	2,5	30	PH2	80	LQ250303080/C	92,50
△	300	3,0	2,5	30	PH2	72	LQ3003030F72/C	86,20
○	300	3,0	2,5	30	PH2	96	LQ3003030F96/C	112,30
△	350	3,2	2,5	30	PH2	84	LQ3503230F84/C	102,20
△	350	3,2	2,5	30	PH2	108	LQ3503230F108/C	119,80

GDA  
High-tech tools

## LAMA CIRCOLARE PER TAGLIO MATERIALI PLASTICI

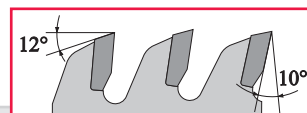
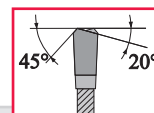

**(GB)** Circular saw blade for plastic material

**(F)** Scie circulaire pour matériel plastique

**(E)** Hoja de sierra para material plastico

I  
M

1  
2  
2



	D	B	b	d	●●●	Z	COD	€
○	200	3,0	2,5	30		64	LV200303064/C	86,20
△	200	3,0	2,5	35		64	LV200303564/C	94,20
○	250	3,0	2,5	30	PH2	80	LV250303080/C	95,80
○	300	3,0	2,5	30	PH2	96	LV3003030F96/C	116,20
○	350	3,2	2,5	30	PH2	108	LV3503230F108/C	126,50

GDA  
High-tech tools

I  
M

## LAMA CIRCOLARE A SPESSORE EXTRASOTTILE

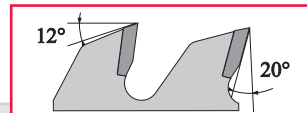
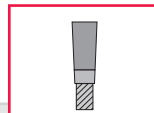
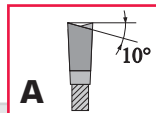

**(GB)** Extra thin circular saw blade

**(F)** Scie circulaire extra mince

**(E)** Hoja de sierra extra - delgada

1  
2  
3



	D	B	b	d	●●●	Z	COD	€
□	180	1,8	1,3	40		28	LF180184028	74,80
□	180	1,8	1,3	60		28	LF1801860F28	74,80
□	200	1,8	1,3	40		32	LF200184032	82,20
□	200	1,8	1,3	60	3/9/74	32	LF2001860F32	82,20
□	225	1,8	1,3	40		36	LF225184036	89,60
□	225	1,8	1,3	60	3/9/74	36	LF2251860F36	89,60
□	225	2,0	1,4	40		36	LF225204036	74,30
□	225	2,0	1,4	60	3/9/74	36	LF2252060F36	74,30
○	250	2,0	1,4	30	PH2	40A	LF2502030F40	72,80
□	250	2,0	1,4	40		40	LF250204040	77,60
□	250	2,0	1,4	60	3/9/74	40	LF2502060F40	77,60

GAA  
High-tech tools

I  
M

## LAMA CIRCOLARE A SPESSORE EXTRASOTTILE

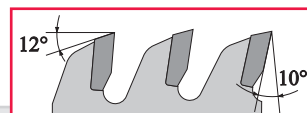
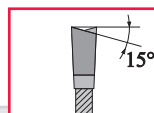

**(GB)** Extra thin circular saw blade

**(F)** Scie circulaire extra mince

**(E)** Hoja de sierra extra - delgada

1  
2  
4



	D	B	b	d	●●●	Z	COD	€
□	150	1,6	1,1	30		48	LF150163048	78,60
△	150	2,0	1,4	30		36	LF150203036	60,20
□	180	1,8	1,3	30		56	LF180183056	89,50
□	180	2,0	1,4	30		48	LF180203048	70,00
△	200	2,0	1,4	30		48	LF200203048	72,00
△	200	2,0	1,4	30		64	LF200203064	82,80
○	250	2,0	1,4	30	PH2	60	LF2502030F60	84,50
○	250	2,0	1,4	30	PH2	80	LF2502030F80	101,20
○	300	2,0	1,4	30	PH2	72	LF3002030F72	100,80
○	300	2,0	1,4	30	PH2	96	LF3002030F96	118,80
□	350	2,5	1,8	30	PH2	84	LF3502530F84	124,00
□	350	2,5	1,8	30	PH2	108	LF3502530F108	146,60

GAA  
High-tech tools

I  
M

## LAMA CIRCOLARE UNIVERSALE A SPESSORE SOTTILE

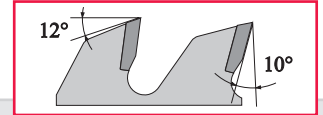
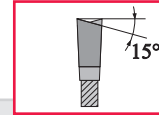

**GB** Universal thin circular saw blade

**F** Scie circulaire universelle avec épaisseur mince

**E** Hoja de sierra delgada para empleo universal

1  
2  
5

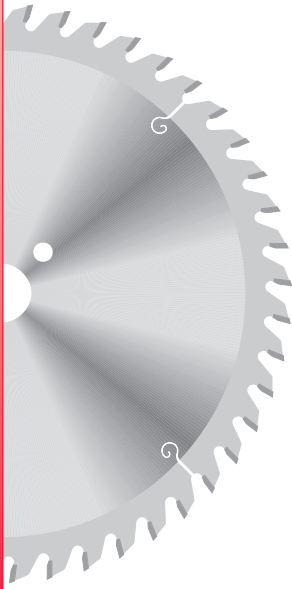

	D	B	b	d	●●●	Z	COD	€
○	150	2,5	1,8	30		24	LF150253024	38,00
○	180	2,5	1,8	30		30	LF180253030	43,30
○	200	2,5	1,8	30		34	LF200253034	44,10
○	250	2,5	1,8	30	PH2	40	LF2502530F40	51,70
○	300	2,5	1,8	30	PH2	48	LF3002530F48	58,60
○	350	2,8	2,0	30	PH2	54	LF3502830F54	80,00
△	400	3,6	2,5	30	PH2	60	LF4003630F60	108,60

**GDA**  
High-tech tools

I  
M

## LAMA CIRCOLARE UNIVERSALE A SPESSORE SOTTILE

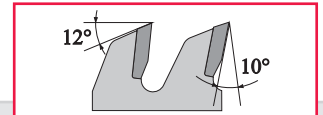
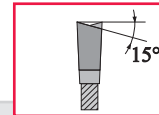

**GB** Universal thin circular saw blade

**F** Scie circulaire universelle avec épaisseur mince

**E** Hoja de sierra delgada para empleo universal

1  
2  
6

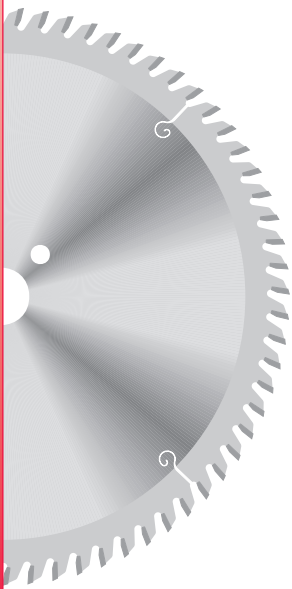

	D	B	b	d	●●●	Z	COD	€
□	150	2,5	1,8	30		36	LF150253036	52,00
□	180	2,5	1,8	30		48	LF180253048	68,00
○	200	2,5	1,8	30		48	LF200253048	54,40
○	250	2,5	1,8	30	PH2	60	LF2502530F60	61,50
○	300	2,5	1,8	30	PH2	72	LF3002530F72	73,00
□	350	2,8	2,0	30	PH2	84	LF3502830F84	88,90
△	400	3,6	2,5	30	PH2	96	LF4003630F96	139,50

**GDA**  
High-tech tools

○ △ □ \* Ⓢ Ⓣ Ⓤ = vedi pagina 6 / see page 6 / voir page 6 / vease pagina 6

I  
M

## LAMA CIRCOLARE A SPESSORE SOTTILE AD ALTO RENDIMENTO

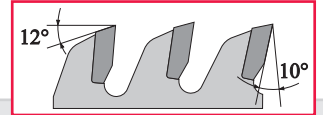
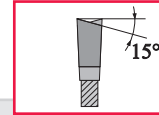

High - efficiency thin circular saw blade



Scie circulaire mince avec haut rendement



Hoja de sierra delgada de alto rendimiento

1  
2  
7

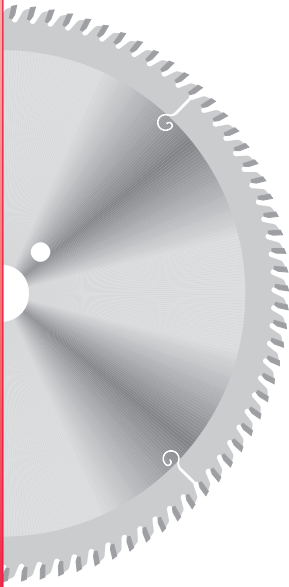

	D	B	b	d	●●●	Z	COD	€
○	150	2,5	1,8	30		48	LF150253048	48,20
○	200	2,5	1,8	30		64	LF200253064	60,50
○	250	2,5	1,8	30	PH2	80	LF2502530F80	73,60
○	300	2,5	1,8	30	PH2	96	LF3002530F96	84,30
○	350	2,8	2,0	30	PH2	108	LF3502830F108	101,70
△	400	3,6	2,5	30	PH2	120	LF4003630F120	147,30



I  
M

## LAMA CIRCOLARE PER TAGLI TRASVERSALI SENZA SCHEGGIATURE

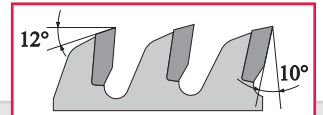
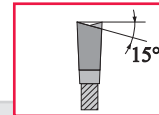

Transversal cutting circular saw blade without chipping



Scie circulaire pour débits transversaux sans ébrèchement



Hoja de sierra para cortes trasversales sin astillado

1  
2  
8



	D	B	b	d	●●●	Z	COD	€
○	200	2,5	1,8	30		80	LF200253080	100,00
○	250	2,5	1,8	30	PH2	100	LF2502530F100	112,00
○	300	2,5	1,8	30	PH2	120	LF3002530F120	130,00



I  
M

## LAMA CIRCOLARE CON RINFORZO A SPESSORE EXTRASOTTILE

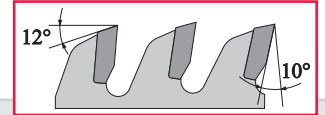
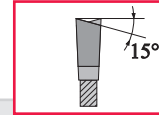

**(GB)** Extra thin circular saw blade with hub

**(F)** Scie circulaire extra mince avec corps renforcé

**(E)** Hoja de sierra extra - delgada con rebajes del cuerpo base

1  
2  
9



	D	B	b	d	●●●	NT	Z	COD	€
○	125	1,5	2,2/1,0	30		22	40	LX125153040	97,60
△	150	1,5	2,2/1,0	30		25	48	LX150153048	99,30
○	180	1,5	2,2/1,0	30		27	56	LX180153056	101,50
○	200	1,6	2,2/1,1	30		28	64	LX200163064	108,50
○	250	1,6	2,2/1,1	30	PH2	35	80	LX2501630F80	121,00
○	300	1,7	2,2/1,2	30	PH2	40	96	LX3001730F96	140,00

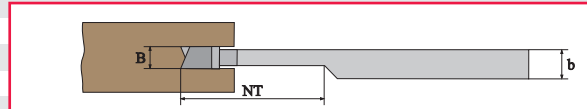

GDA High-tech tools

I  
M

## COPPIA DI LAME A SPESSORE REGOLABILE CON ANELLI

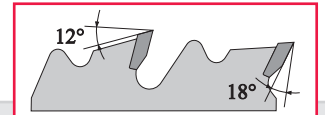
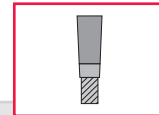

**(GB)** Adjustable thickness grooving saw blade with spacers

**(F)** Scie pour rainure avec épaisseur réglable et avec bagues

**(E)** Hoja de sierra para ranurar a espesor regulable con anillos

1  
3  
0

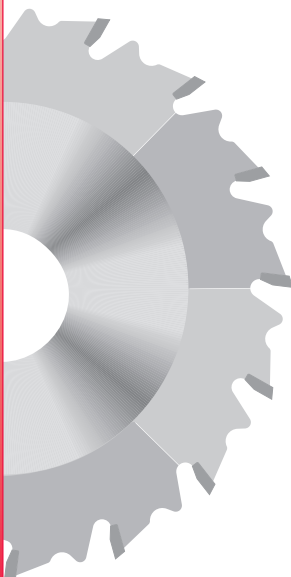

	D	B	b	d	NT	Z	COD	€
○	120	1,8/3,4	8,8	30	15	8+8 LT	LD120183016	160,00
○	120	1,8/3,4	8,8	35	15	8+8 LT	LD120183516	160,00
○	120	2,2/4,2	9,2	30	15	8+8 LT	LD120223016	160,00
○	120	2,2/4,2	9,2	35	15	8+8 LT	LD120223516	160,00
○	140	1,8/3,4	8,8	30	18	8+8 LT	LD140183016	175,00
○	140	1,8/3,4	8,8	35	18	8+8 LT	LD140183516	175,00
○	140	2,2/4,2	9,2	30	18	8+8 LT	LD140223016	175,00
○	140	2,2/4,2	9,2	35	18	8+8 LT	LD140223516	175,00
□	200	1,8/3,4	8,8	30	20	12+12 LT	LD200183024	225,00
□	200	1,8/3,4	8,8	35	20	12+12 LT	LD200183524	225,00
□	200	2,2/4,2	9,2	30	20	12+12 LT	LD200223024	225,00
□	200	2,2/4,2	9,2	35	20	12+12 LT	LD200223224	225,00

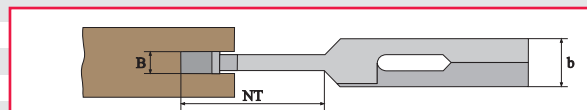

GDA High-tech tools

I  
M

1  
3  
2

# LAMA CIRCOLARE A GROSSO SPESSORE

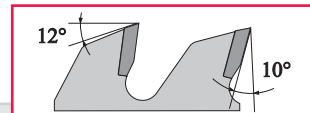
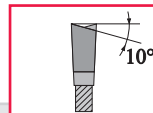

**GB** Universal circular saw blade with big thickness

**F** Scie circulaire universelle avec gros épaisseur

**E** Hoja de sierra espesa para empleo universal

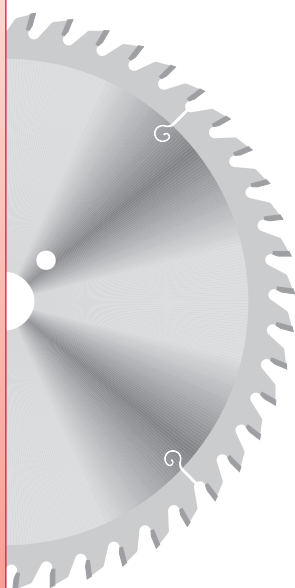

	D	B	b	d	●●●	Z	COD	€
○	150	4,0	2,8	30		24	LX150403024	41,10
□	150	4,0	2,8	30		36	LX150403036	46,30
○	200	4,0	2,8	30		36	LX200403036	53,00
□	200	4,0	2,8	30		48	LX200403048	60,80
○	250	4,0	2,8	30	PH2	40	LX2504030F40	60,80
□	250	4,0	2,8	30	PH2	48	LX2504030F48	74,00
○	250	4,0	2,8	30	PH2	60	LX2504030F60	66,30
□	250	5,0	3,6	30	PH2	48	LX2505030F48	89,00
○	300	4,0	2,8	30	PH2	48	LX3004030F48	71,40
□	300	4,0	2,8	30	PH2	60	LX3004030F60	102,00
○	300	4,0	2,8	30	PH2	72	LX3004030F72	92,60
□	300	5,0	3,6	30	PH2	60	LX3005030F60	121,50
□	350	4,0	2,8	30	PH2	72	LX3504030F72	109,00
□	350	5,0	3,6	30	PH2	72	LX3505030F72	148,60

I  
M

## LAMA CIRCOLARE PER TAGLI LONGITUDINALI E TRASVERSALI

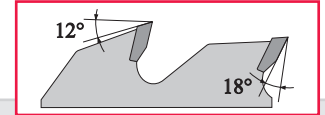
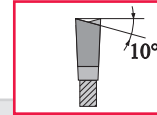

**(GB)** Lengthwise and transversal cutting circular saw blade

**(F)** Scie circulaire pour coupes longitudinales et transversales

**(E)** Hoja de sierra para empleo cortes longitudinales e transversales

1  
3  
8

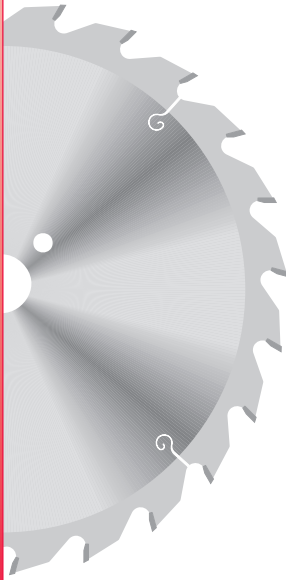

	D	B	b	d	•●•	Z	COD	€
□	720	6,0	4,4	30	2/10/60+2/8,5/90	72	LX7206030F72	665,00
□	735	6,0	4,4	30	2/10/60+2/8,5/90	48+LT	LL7356030F48	600,00
□	735	6,0	4,4	30	2/10/60+2/8,5/90	72	LX7356030F72	665,00
□	750	6,0	4,4	30	2/10/60+2/8,5/90	60	LX7506030F60	675,00
□	750	7,0	5,0	30	2/10/60+2/8,5/90	60	LX7507030F60	765,00
□	760	6,0	4,4	30	2/10/60+4/8,5/90	72	LX7606030F72	680,00
□	800	6,0	4,4	30	2/10/60+4/8,5/90	72	LX8006030F72	740,00
□	800	6,5	4,4	30	2/10/60+4/8,5/90	72	LX8006530F72	780,00
□	800	7,0	5,0	30	2/10/60+4/8,5/90	72	LX8007030F72	840,00
□	800	7,0	5,0	40		84	LX800704084	880,00
□	800	7,0	5,0	30	2/10/60+4/8,5/90	96	LX8007030F96	920,00

GDA  
High-tech tools

I  
M

## LAMA CIRCOLARE PER TAGLI LONGITUDINALI E TRASVERSALI CON RASANTI

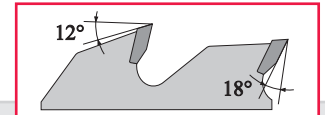
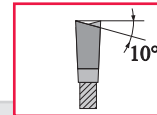

**(GB)** Lengthwise and transversal cutting circular saw blade with strobes

**(F)** Scie circulaire pour coupes longitudinaux et transversaux avec racleurs

**(E)** Hoja de sierra para empleo cortes longitudinales e transversales con rasuradores

1  
3  
9

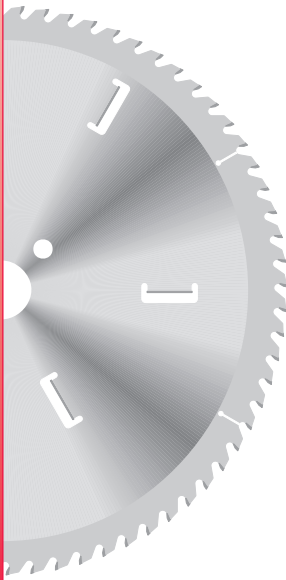

	D	B	b	d	•●•	Z	COD	€
△	735	6,0	4,4	30	2/10/60+2/8,5/90	48+6	LM7356030F488	770,00
△	735	6,0	4,4	30	2/10/60+2/8,5/90	72+6	LM7356030F728	835,00
□	750	6,0	4,4	30	2/10/60+2/8,5/90	48+6	LM7506030F488	845,00
○	760	6,0	4,4	30	2/10/60+4/8,5/90	72+6	LM7606030F728	850,00
□	800	6,0	4,4	30	2/10/60+4/8,5/90	72+6	LM8006030F728	915,00

GDA  
High-tech tools

# LAMA CIRCOLARE CON RASANTI PER MULTILAME

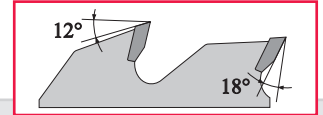
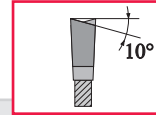

**GB** Circular saw blade with shavings for multirip saw machines

**F** Scie circulaire avec racleurs pour machine multilames

**E** Hoja de sierra con rasantes para sierra multiple

I  
M

1  
4  
0

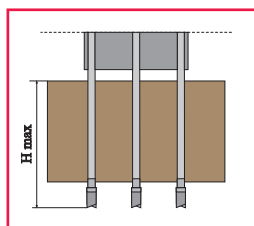
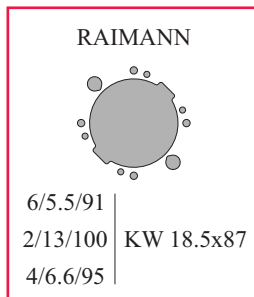
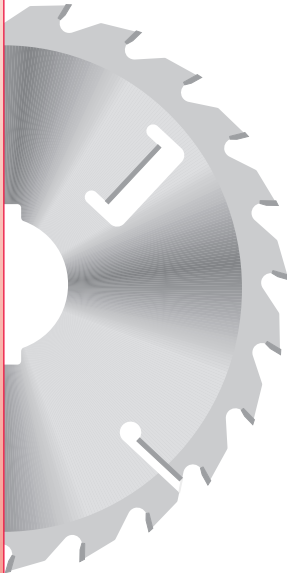

	D	B	b	d		Z+R	H	COD	€
○	250	3,2	2,2	30		20+2+2	65	Lm2503230204	59,90
○	250	3,2	2,2	60	21x74	20+2+2	65	LM2503260K204	59,90
○	250	3,2	2,2	70	21x84	20+2+2	65	LM2503270K204	59,50
○	250	3,2	2,2	80	13x90	20+2+2	65	LM2503280K204	59,50
○	280	3,2	2,2	70	21x84	24+2+2	70	LM2803270K244	69,10
○	280	3,2	2,2	80	13x90	24+2+2	70	LM2803280K244	69,10
○	300	3,2	2,2	30		24+2+2	80	LM3003230244	69,10
△	300	3,2	2,2	50		24+2+2	80	LM3003250244	69,10
○	300	3,2	2,2	60	21x74	24+2+2	80	LM3003260K244	69,10
○	300	3,2	2,2	70	21x84	24+2+2	80	LM3003270K244	68,60
○	300	3,2	2,2	75	21x91	24+2+2	80	LM3003275K244	69,10
○	300	3,2	2,2	80	13x90	24+2+2	80	LM3003280K244	68,60
□	300	3,2	2,2	80	RAIMANN	24+2+2	80	LM3003280KF244	71,90
□	300	3,4	2,2	80	13x90	24+2+2	80	LM3003480K244	71,90
△	320	3,2	2,2	70	21x84	24+2+2	90	LM3203270K244	81,20
○	320	3,2	2,2	80	13x90	24+2+2	90	LM3203280K244	81,20
□	320	3,2	2,2	90	21x110	24+2+2	85	LM3203290K244	81,20
□	320	3,2	2,2	100	13x110	24+2+2	85	LM32032100K244	81,20
○	350	3,5	2,5	30		24+2+4	105	LM3503530246	89,20
△	350	3,5	2,5	50		24+2+4	105	LM3503550246	89,20
□	350	3,5	2,5	60	21x74	24+2+4	105	LM3503560K246	89,20
○	350	3,5	2,5	70	21x84	24+2+4	105	LM3503570K246	88,80
○	350	3,5	2,5	75	21x91	24+2+4	105	LM3503575K246	89,20
○	350	3,5	2,5	80	14x92	24+2+4	105	LM3503580K246	88,80
□	350	3,5	2,5	80	RAIMANN	24+2+4	105	LM3503580KF246	92,60
○	350	3,5	2,5	90	21x110	24+2+4	95	LM3503590K246	89,20
□	350	3,5	2,5	95	21x109	24+2+4	95	LM3503595K246	89,20
□	350	3,5	2,5	100	13x112	24+2+4	95	LM35035100K246	89,20
□	350	3,5	2,5	105	21x119	24+2+4	95	LM35035105K246	89,20
□	350	3,8	2,5	30		24+2+4	105	LM3503830246	92,60
□	350	3,8	2,5	70	21x84	24+2+4	105	LM3503870K246	92,60
□	350	3,8	2,5	80	14x92	24+2+4	105	LM3503880K246	92,60
□	350	3,8	2,5	90	21x110	24+2+4	95	LM3503890K246	92,60
□	380	4,0	2,8	70	21x84	28+2+4	115	LM3804070K286	115,80
□	380	4,0	2,8	75	21x91	28+2+4	115	LM3804075K286	115,80
□	380	4,0	2,8	100	13x112	28+2+4	115	LM38040100K286	115,80
○	400	4,0	2,8	30		28+2+4	120	LM4004030286	113,30
△	400	4,0	2,8	50		28+2+4	120	LM4004050286	113,30
○	400	4,0	2,8	70	21x84	28+2+4	120	LM4004070K286	112,90
○	400	4,0	2,8	75	21x91	28+2+4	120	LM4004075K286	113,30
○	400	4,0	2,8	80	14x92	28+2+4	120	LM4004080K286	112,90
○	400	4,0	2,8	90	21x110	28+2+4	120	LM4004090K286	112,90
□	400	4,0	2,8	95	21x109	28+2+4	120	LM4004095K286	113,30
□	400	4,0	2,8	100	13x112	28+2+4	120	LM40040100K286	113,30
□	400	4,0	2,8	110	21x130	28+2+4	120	LM40040110K286	113,30



I  
M

1  
4  
1

# LAMA CIRCOLARE CON RASANTI PER MULTILAME

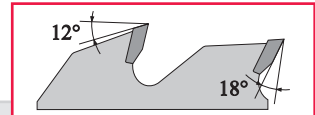
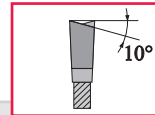

**GB** Circular saw blade with shavings  
for multirip saw machines

**F** Scie circulaire avec racleurs  
pour machine multilames

**E** Hoja de sierra con rasantes  
para sierra multiple

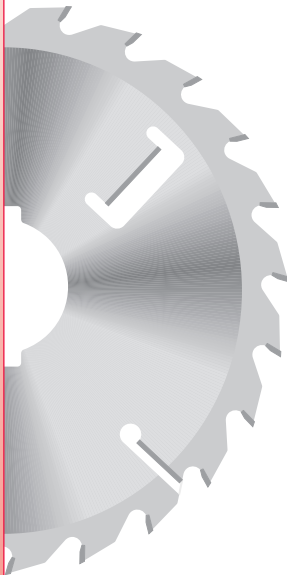

	D	B	b	d		Z+R	H	COD	€
○	450	4,6	3,2	30		24+2+4	135	LM4504630246	157,60
△	450	4,6	3,2	50		24+2+4	135	LM4504650246	157,60
○	450	4,6	3,2	70	21x84	24+2+4	135	LM4504670K246	157,60
○	450	4,6	3,2	75	21x91	24+2+4	135	LM4504675K246	157,60
○	450	4,6	3,2	80	13x92	24+2+4	135	LM4504680K246	157,60
○	450	4,6	3,2	90	21x110	24+2+4	135	LM4504690K246	157,60
○	500	4,6	3,2	30		26+2+6	175	LM5004630268	219,70
△	500	4,6	3,2	50		26+2+6	175	LM5004650268	219,70
□	500	4,6	3,2	70	21x84	26+2+6	175	LM5004670K268	219,70
□	500	4,6	3,2	80	13x92	26+2+6	175	LM5004680K268	219,70
□	500	4,6	3,2	110	18x130	26+2+6	165	LM50046110K268	219,70
□	500	4,6	3,2	130	18x146	26+2+4	135	LM50046130K266	219,70
□	550	4,8	3,6	30		28+2+6	175	LM5504830288	278,80
□	550	4,8	3,6	50		28+2+6	175	LM5504850288	278,80
□	550	4,8	3,6	80	13x92	28+2+6	175	LM5504880K288	278,80
□	550	4,8	3,6	110	21x130	28+2+6	175	LM55048110K288	278,80
□	550	4,8	3,6	130	18x146	28+2+6	165	LM55048130K288	278,80
□	550	4,8	3,6	150	21x167	28+2+6	165	LM55048150K288	278,80
□	600	4,8	3,6	30		32+2+6	175	LM6004830328	338,20
□	600	4,8	3,6	50		32+2+6	175	LM6004850328	338,20
□	600	4,8	3,6	80	13x92	32+2+6	175	LM6004880K328	338,20
□	600	4,8	3,6	90	21x110	32+2+6	175	LM6004890K328	338,20

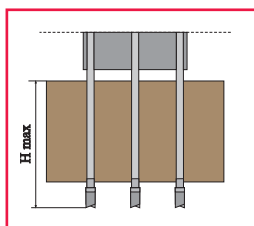

I  
M

1  
4  
2

# LAMA CIRCOLARE CON RASANTI PER MULTILAME TIPO "GDA-COATED"

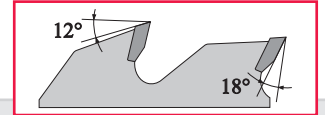
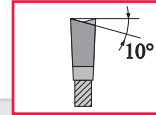

**GB** Circular saw "GDA - coated" with shavings for multirip saw machines

**F** Scie circulaire avec racleurs pour machine multilames "GDA - coated"

**E** Hoja de sierra con rasantes para sierra multiple "GDA - coated"



	D	B	b	d		Z+R	H	COD	€
□	300	3,2	2,2	70	21x84	24+2+2	80	LM3003270K244/C	75,60
□	300	3,2	2,2	80	13x90	24+2+2	80	LM3003280K244/C	75,60
□	350	3,5	2,5	70	21x84	24+2+4	105	LM3503570K246/C	97,40
□	350	3,5	2,5	80	14x92	24+2+4	105	LM3503580K246/C	97,40
□	350	3,5	2,5	90	21x110	24+2+4	105	LM3503590K246/C	97,40
□	400	4,0	2,8	70	21x84	28+2+4	120	LM4004070K286/C	123,50
□	400	4,0	2,8	80	14x92	28+2+4	120	LM4004080K286/C	123,50
□	400	4,0	2,8	90	21x110	28+2+4	120	LM4004090K286/C	123,50
○	450	5,2	3,2	70	21x84	28+2+4	135	LM4505270K286/C	195,20
○	450	5,2	3,2	75	21x91	28+2+4	135	LM4505275K286/C	195,20
○	450	5,2	3,2	80	13x92	28+2+4	135	LM4505280K286/C	195,20
□	450	5,2	3,2	90	21x110	28+2+4	135	LM4505290K286/C	195,20
□	450	5,2	3,2	55	6/16-22/112	28+2+4	135	LM4505255F286/C	195,20
□	450	5,2	3,2	a richiesta / upon request		28+2+4			195,20
□	500	5,2	3,6	70	21x84	32+2+6	175	LM5005270K328/C	276,10
□	500	5,2	3,6	80	13x92	32+2+6	175	LM5005280K328/C	276,10
□	500	5,2	3,6	110	18x130	32+2+6	165	LM50052110K328/C	276,10
□	500	5,2	3,6	130	18x146	32+2+4	135	LM50052130K326/C	276,10
□	500	5,2	3,6	55	6/16-22/112	32+2+6	175	LM5005255F328/C	276,10
□	500	5,2	3,6	a richiesta / upon request		32+2+6			276,10
□	550	5,2	3,6	80	13x92	32+2+6	175	LM5505280K328/C	351,80
□	550	5,2	3,6	110	21x130	32+2+6	175	LM55052110K328/C	351,80
□	550	5,2	3,6	130	18x146	32+2+6	165	LM55052130K328/C	351,80
□	550	5,2	3,6	150	21x167	32+2+6	165	LM55052150K328/C	351,80
□	550	5,2	3,6	55	6/16-22/112	32+2+6	175	LM5505255F328/C	351,80
□	550	5,2	3,6	a richiesta / upon request		32+2+6			351,80
○	550	6,2	3,6	90	21x107	24+2+6	180	LM5506290K248/C	351,80
□	600	5,2	3,6	a richiesta / upon request		32+2+6	175		435,70
□	630	6,2	4,0	a richiesta / upon request		36+2+6	215		480,60
□	650	6,2	4,0	a richiesta / upon request		36+2+6	215		512,90
□	700	6,2	4,0	a richiesta / upon request		36+2+6	215		543,80

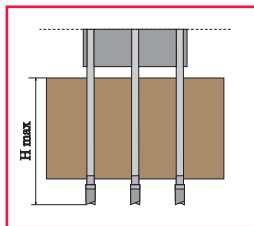

I  
M

1  
4  
3

# LAMA CIRCOLARE DI SPALLA CON RASANTI PER MULTILAME

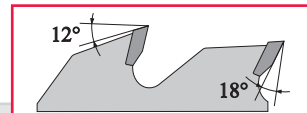
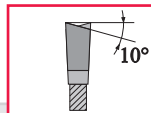

**GB** Thick saw blade with shavings for multirip saw machines

**F** Scie circulaire d'épaule avec racleurs pour machine multilames

**E** Hoja de sierra espesa con rasadores para multihojas

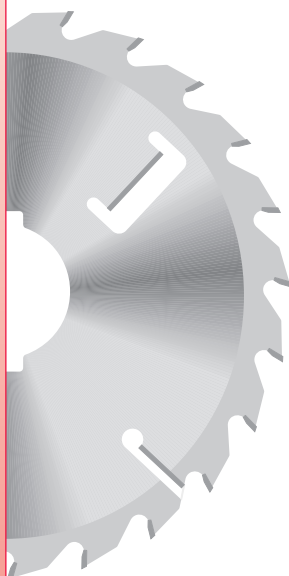

	D	B	b	d		Z+R	H	COD	€
△	250	4,0	2,8	70	21x84	20+2+2	65	LM2504070K204	73,20
□	250	4,0	2,8	80	13x90	20+2+2	65	LM2504080K204	73,20
○	300	4,0	2,8	70	21x84	24+2+2	80	LM3004070K244	83,60
△	300	4,0	2,8	75	21x91	24+2+2	80	LM3004075K244	83,60
○	300	4,0	2,8	80	13x90	24+2+2	80	LM3004080K244	83,60
○	300	5,2	3,6	70	21x84	24+2+2	80	LM3005270K244	108,70
○	300	5,2	3,6	75	21x91	24+2+2	80	LM3005275K244	108,70
○	300	5,2	3,6	80	13x90	24+2+2	80	LM3005280K244	108,70
△	320	4,0	2,8	70	21x84	24+2+2	90	LM3204070K244	89,60
○	320	4,0	2,8	80	13x90	24+2+2	90	LM3204080K244	89,60
○	350	4,2	2,8	70	21x84	24+2+4	105	LM3504270K246	95,40
○	350	4,2	2,8	75	21x91	24+2+4	105	LM3504275K246	95,40
○	350	4,2	2,8	80	14x92	24+2+4	105	LM3504280K246	95,40
○	350	4,5	3,2	70	21x84	24+2+4	105	LM3504570K246	111,60
○	350	4,5	3,2	75	21x91	24+2+4	105	LM3504575K246	111,60
○	350	4,5	3,2	80	14x92	24+2+4	105	LM3504580K246	111,60
△	350	4,5	3,2	90	21x110	24+2+4	95	LM3504590K246	111,60
○	350	5,2	3,6	70	21x84	24+2+4	105	LM3505270K246	128,50
○	350	5,2	3,6	75	21x91	24+2+4	105	LM3505275K246	128,50
○	350	5,2	3,6	80	14x92	24+2+4	105	LM3505280K246	128,50
□	350	6,0	4,0	30	4/11/80	24+2+4	105	LM3506030F246	141,00
□	400	4,5	3,2	70	21x84	28+2+4	120	LM4004570K286	128,70
□	400	4,5	3,2	75	21x91	28+2+4	120	LM4004575K286	128,70
□	400	4,5	3,2	80	14x92	28+2+4	120	LM4004580K286	128,70
□	400	4,5	3,2	90	21x110	28+2+4	120	LM4004590K286	128,70
□	400	6,0	4,0	30	4/11/80	28+2+4	120	LM4006030F286	162,00
□	450	6,0	4,0	30	4/11/80	28+2+4	135	LM4506030F286	210,60
□	500	6,0	4,0	30	4/13/90	32+2+6	175	LM5006030F328	264,60
□	550	6,0	4,0	30	4/13/90	32+2+6	175	LM5506030F328	305,40
□	600	6,0	4,0	40	4/13/105	36+2+6	175	LM6006040F368	370,00

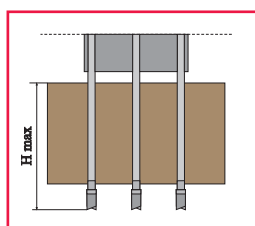

I  
M

1  
4  
4

# LAMA CIRCOLARE CON RASANTI PER MULTILAME A SPESSORE SOTTILE

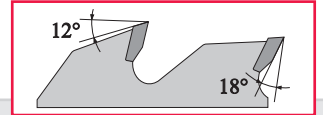
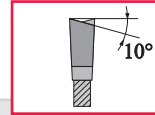

Circular saw blade with shavings  
for multirip saw machines with  
thin thickness



Scie circulaire avec racleurs et mince  
épaisseur pour machine multilames



Hoja circular con rasadores  
para multihojas a espesor sutil

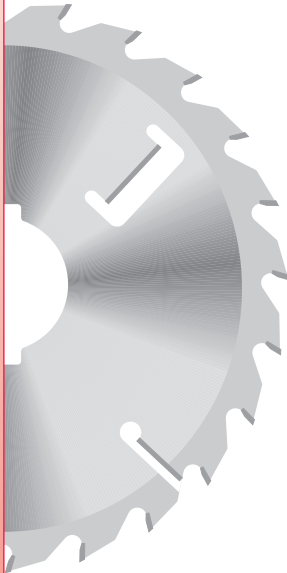

	D	B	b	d		Z+R	H	COD	€
○	180	2,5	1,8	35		21+3	30	LM1802535213	55,00
○	180	2,5	1,8	40		21+3	30	LM1802540213	55,00
○	200	2,5	1,8	35		21+3	35	LM2002535213	55,00
○	200	2,5	1,8	40		21+3	35	LM2002540213	55,00
□	225	2,5	1,8	40		21+3	40	LM2252540213	58,60
□	225	2,5	1,8	60		21+3	40	LM2252560213	58,60
△	250	2,5	1,8	60	21x74	20+2+2	50	LM2502560K204	60,50
△	250	2,5	1,8	70	21x84	20+2+2	50	LM2502570K204	60,50
△	250	2,5	1,8	80	13x90	20+2+2	50	LM2502580K204	60,50
○	250	2,7	1,8	60	21x74	20+2+2	50	LM2502760K204	59,50
○	250	2,7	1,8	70	21x84	20+2+2	50	LM2502770K204	59,50
○	250	2,7	1,8	80	13x90	20+2+2	50	LM2502780K204	59,50
△	300	2,5	1,8	60	21x74	24+2+2	60	LM3002560K244	70,10
△	300	2,5	1,8	70	21x84	24+2+2	60	LM3002570K244	70,10
△	300	2,5	1,8	80	13x90	24+2+2	60	LM3002580K244	70,10
○	300	2,7	1,8	60	21x74	24+2+2	60	LM3002760K244	69,10
○	300	2,7	1,8	70	21x84	24+2+2	60	LM3002770K244	69,10
○	300	2,7	1,8	80	13x90	24+2+2	60	LM3002780K244	69,10
□	350	3,0	2,0	70	21x84	24+2+4	70	LM3503070K246	89,20
□	350	3,0	2,0	80	14x92	24+2+4	70	LM3503080K246	89,20

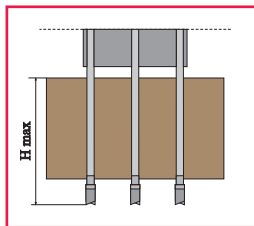

I  
M

1  
4  
5



## LAMA CIRCOLARE CON RASANTI PER MULTILAME A SPESSORE EXTRA - SOTTILE

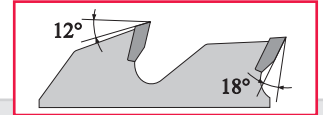
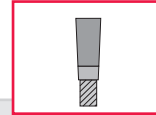

**(GB)** Circular saw blade with shavings for multiprip saw machines with extra thin thickness

**(F)** Scie circulaire avec racleurs et épaisseur extra mince pour machine multilames

**(E)** Hoja de sierra con rasadores para multihojas a espesor extra - sutil



	D	B	b	d		Z+R	H	COD	€
<input type="checkbox"/>	250	2,0	1,4	40		20+2+2	40	LM2502040204/C	78,90
<input type="checkbox"/>	250	2,0	1,4	60		20+2+2	40	LM2502060204/C	78,90
<input type="checkbox"/>	250	2,2	1,6	70	21x84	20+2+2	45	LM2502270K204/C	71,70
<input type="checkbox"/>	250	2,2	1,6	80	13x90	20+2+2	45	LM2502280K204/C	71,70
<input type="checkbox"/>	250	2,4	1,6	70	21x84	20+2+2	45	LM2502470K204/C	71,70
<input type="checkbox"/>	250	2,4	1,6	80	13x90	20+2+2	45	LM2502480K204/C	71,70
<input type="checkbox"/>	300	1,8	1,3	60		24+2+2	35	LM3001860244/C	104,80
<input type="checkbox"/>	300	1,8	1,3	70	21x84	24+2+2	35	LM3001870K244/C	104,80
<input type="checkbox"/>	300	1,8	1,3	80	13x90	24+2+2	35	LM3001880K244/C	104,80
<input type="checkbox"/>	300	2,0	1,4	60		24+2+2	40	LM3002060244/C	90,90
<input type="checkbox"/>	300	2,0	1,4	70	21x84	24+2+2	40	LM3002070K244/C	90,90
<input type="checkbox"/>	300	2,0	1,4	80	13x90	24+2+2	40	LM3002080K244/C	90,90
<input type="checkbox"/>	300	2,2	1,6	60		24+2+2	45	LM3002260244/C	82,60
<input type="checkbox"/>	300	2,2	1,6	70	21x84	24+2+2	45	LM3002270K244/C	82,60
<input type="checkbox"/>	300	2,2	1,6	80	13x90	24+2+2	45	LM3002280K244/C	82,60
<input type="checkbox"/>	300	2,4	1,6	70	21x84	24+2+2	50	LM3002470K244/C	82,60
<input type="checkbox"/>	300	2,4	1,6	80	13x90	24+2+2	50	LM3002480K244/C	82,60

## LAMA CIRCOLARE CON RASANTI PER MULTILAME A SPESSORE EXTRA - SOTTILE E LIMITATORE

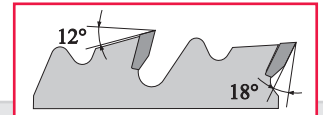
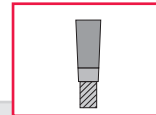

**(GB)** Circular saw blade with shavings and chip limiter for multiprip saw machines with extra thin thickness

**(F)** Scie circulaire avec racleurs et épaisseur extra mince et limiteur de coupe pour machine multilames

**(E)** Hoja de sierra con rasadores para multihojas a espesor extra - sutil y limitadores



	D	B	b	d		Z+R	H	COD	€
<input type="checkbox"/>	180	2,0	1,4	40		16 LT+2	30	LM1802040162X/C	70,50
<input type="checkbox"/>	180	2,0	1,4	60		16 LT+2	30	LM1802060162X/C	70,50
<input type="checkbox"/>	180	2,2	1,6	40		16 LT+2	35	LM1802240162X/C	64,10
<input type="checkbox"/>	180	2,2	1,6	60		16 LT+2	35	LM1802260162X/C	64,10
<input type="checkbox"/>	200	2,0	1,4	40		16 LT+2	35	LM2002040162X/C	70,90
<input type="checkbox"/>	200	2,0	1,4	60		16 LT+2	35	LM2002060162X/C	70,90
<input type="checkbox"/>	200	2,2	1,6	40		16 LT+2	40	LM2002240162X/C	64,50
<input type="checkbox"/>	200	2,2	1,6	60		16 LT+2	40	LM2002260162X/C	64,50
<input type="checkbox"/>	200	2,4	1,6	40		16 LT+2	40	LM2002440162X/C	64,50
<input type="checkbox"/>	200	2,4	1,6	60		16 LT+2	40	LM2002460162X/C	64,50
<input type="checkbox"/>	225	2,0	1,4	30		20 LT+2	40	LM2252030202X/C	77,40
<input type="checkbox"/>	225	2,0	1,4	40		20 LT+2	40	LM2252040202X/C	77,40
<input type="checkbox"/>	225	2,0	1,4	60		20 LT+2	40	LM2252060202X/C	77,40
<input type="checkbox"/>	225	2,0	1,4	70	21x84	20 LT+2	40	LM2252070K202X/C	77,40
<input type="checkbox"/>	225	2,2	1,6	30		20 LT+2	40	LM2252230202X/C	70,00
<input type="checkbox"/>	225	2,2	1,6	40		20 LT+2	40	LM2252240202X/C	70,00
<input type="checkbox"/>	225	2,2	1,6	60		20 LT+2	40	LM2252260202X/C	70,00
<input type="checkbox"/>	225	2,2	1,6	70	21x84	20 LT+2	40	LM2252270K202X/C	70,00
<input type="checkbox"/>	250	1,6	1,1	40		24 LT+3	35	LM2501640243X/C	98,80
<input type="checkbox"/>	250	1,6	1,1	60		24 LT+3	35	LM2501660243X/C	98,80



I  
M

1  
4  
7

# LAMA CIRCOLARE CON RASANTI PER MULTILAME

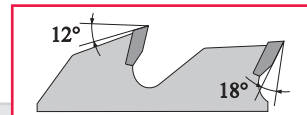
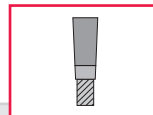

**GB** Circular saw blade with shavings  
for multirip saw machines

**F** Scie circulaire avec racleurs  
pour machine multilames

**E** Hoja de sierra con rasantes  
para sierra múltiple

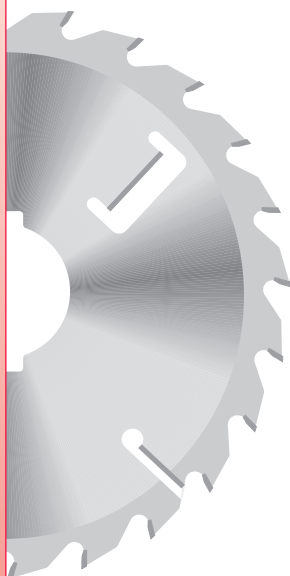

	D	B	b	d		Z+R	COD	€
<input type="checkbox"/>	370	3,7	2,5	150	37x170	36+2+2	LM37037150K364	128,70
<input type="checkbox"/>	390	3,7	2,5	150	37x170	36+2+2	LM39037150K364	128,70
<input type="checkbox"/>	400	3,5	2,5	135	13x145	28+2+4	LM40035135K286	128,70
<input type="checkbox"/>	400	4,0	2,8	120	18x136	28+2+4	LM40040120K286	118,90
<input type="checkbox"/>	400	4,0	2,8	135	13x145	28+2+4	LM40040135K286	118,90
<input type="checkbox"/>	440	3,5	2,5	150	37x170	24+2+2	LM44035150K244	180,40
<input type="checkbox"/>	450	4,4	3,0	110	21x126	36+2+4	LM45044110K366	165,60
<input type="checkbox"/>	450	4,4	3,0	150	37x170	32+2+2	LM45044150K324	165,60
<input type="checkbox"/>	460	4,4	3,0	150	37x170	40+2+2	LM46044150K404	219,00
<input type="checkbox"/>	470	4,4	3,0	115	21x135	28+2+4	LM47044115K286	205,00
<input type="checkbox"/>	500	4,4	3,0	165+8	28x180	28+2+4	LM50044165KF286	241,70
<input type="checkbox"/>	500	4,6	3,2	120	18x136	24+2+4	LM50046120K246	241,70
<input type="checkbox"/>	500	5,2	3,6	135	13x145	28+2+4	LM50052135K286	252,60
<input type="checkbox"/>	500	5,2	3,6	140+8	//	24+2+4	LM50052140F246	252,60
<input type="checkbox"/>	500	5,2	3,6	145+8	20x155	54+2+4	LM50052145KF546	264,00
<input type="checkbox"/>	500	5,2	3,6	150	13x160	24+2+4	LM50052150K246	252,60
<input type="checkbox"/>	510	4,2	2,8	150	37x170	30+2+4	LM51042150K306	275,00
<input type="checkbox"/>	510	5,2	3,6	150	37x170	32+2+6	LM51052150K328	288,00
<input type="checkbox"/>	520	3,6	2,2	150	37x170	36+2+4	LM52036150K366	288,00
<input type="checkbox"/>	530	3,7	2,5	150	37x170	44+2+2	LM53037150K446	275,00
<input type="checkbox"/>	530	5,2	3,6	150	37x170	24+2+6	LM53052150K248	292,00
<input type="checkbox"/>	540	5,2	3,6	165+8	28x180	28+2+6	LM54052165KF288	292,00
<input type="checkbox"/>	550	4,8	3,6	120	18x136	24+2+6	LM55048120K248	292,00
<input type="checkbox"/>	550	5,2	3,6	110	18x126	32+2+6	LM55052110K328	292,00
<input type="checkbox"/>	550	5,2	3,6	140+8	17x150	32+2+6	LM55052140KF328	292,00
<input type="checkbox"/>	580	6,0	4,0	150	37x170	32+2+6	LM58060150K328	370,00
<input type="checkbox"/>	600	5,5	4,0	165+8	28x180	36+2+6	LM60055165KF368	370,00
<input type="checkbox"/>	620	5,6	4,0	170+18	//	36+2+6	LM62056170F368	390,00
<input type="checkbox"/>	660	5,8	4,0	165+8	28x180	52+2+6	LM66058165KF528	460,00
<input type="checkbox"/>	700	5,8	4,0	165+8	28x180	54+2+6	LM70058165KF548	490,00

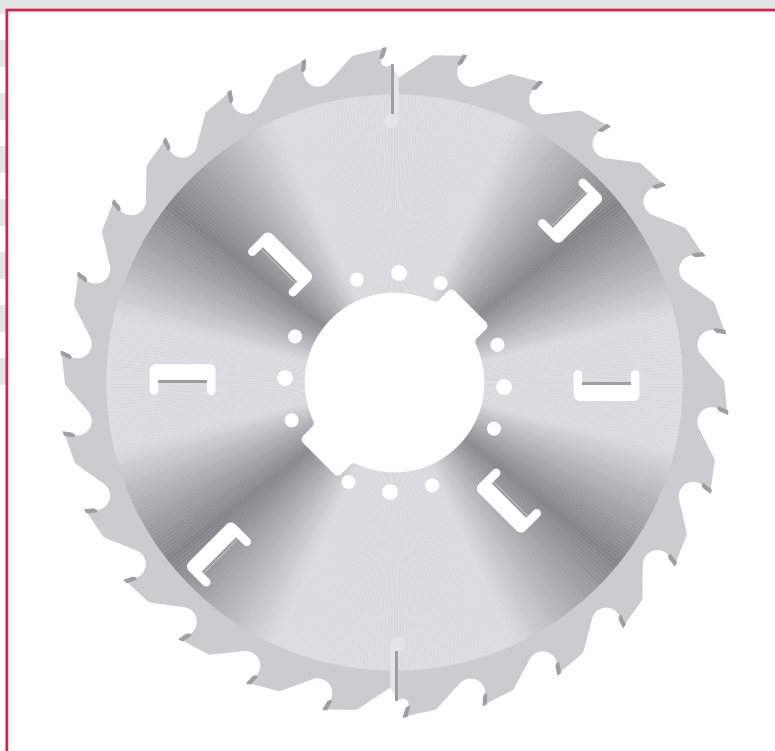

# LAMA CIRCOLARE CON RASANTI PER MULTILAME

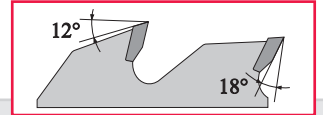
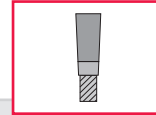

**GB** Circular saw blade with shavings for multirip saw machines

**F** Scie circulaire avec racleurs pour machine multilames

**E** Hoja de sierra con rasantes para sierra múltiple

	D	B	b	b1	d	Z+R	COD DX-RH	COD SX-LH	€
□	440	3,5	2,5	4,7	150	24+3	LM44035150F243D/C	LM44035150F243S/C	300,00
□	440	4,1	3,1	5,4	150	24+2+2	LM44041150F244D/C	LM44041150F244S/C	330,00
□	440	4,6	3,0	6,8	120	24+2+2	LM44046120F244D/C	LM44046120F244S/C	350,00
□	520	5,2	3,6	6,8	120	24+2+4	LM52052120F246D/C	LM52052120F246S/C	410,00
□	550	4,6	3,2	6,8	150	26+2+4	LM55046150F266D/C	LM55046150F266S/C	430,00
□	550	5,5	3,5	6,8	150	26+2+6	LM55055150F268D/C	LM55055150F268S/C	430,00
□	600	5,2	3,6	7,2	80	28+2+4	LM6005280F286D/C	LM6005280F286S/C	580,00
□	600	5,5	3,6	6,8	150	28+2+4	LM60055150F286D/C	LM60055150F286S/C	520,00
□	620	5,6	4,0	6,8	170	36+2+6	LM62056170F368D/C	LM62056170F368S/C	550,00
□	650	5,6	4,0	6,8	150	28+2+6	LM65056150F288D/C	LM65056150F288S/C	550,00

SU RICHIESTA SI PRODUCONO MISURE SPECIALI A DISEGNO

ON REQUEST WE PRODUCE SPECIAL MEASURES DESIGNED

SUR DEMANDE ON PRODUIT MESURES SPÉCIAUX À DESSIN

SU PREGUNTA PRODUCIMOS MEDIDAS ESPECIALES A DIBUJO

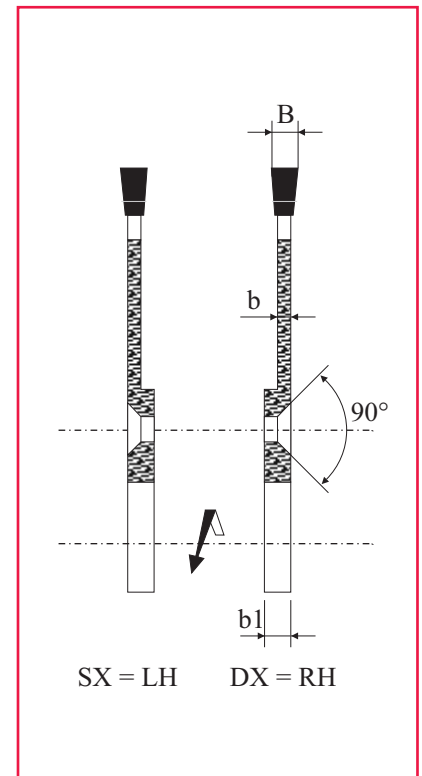
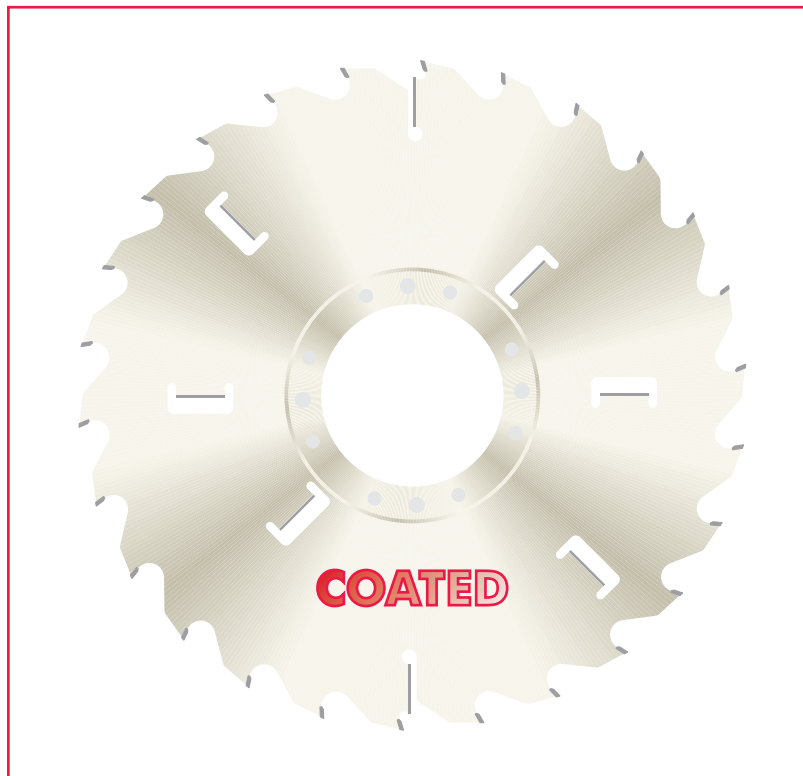

I  
M

1  
4  
8

GDA  
High-tech tools

## LAMA CIRCOLARE PER MULTILAME

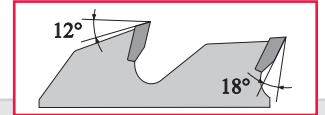
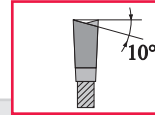

**(GB)** Circular saw blade for multirip saw machines

**(F)** Scie circulaire pour machine multilames

**(E)** Hoja de sierra para sierras multiples

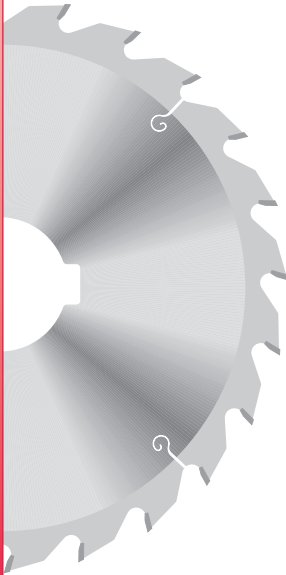

	D	B	b	d		Z	COD	€
○	250	3,2	2,2	70	21x84	20	LN2503270K20	42,50
△	250	3,2	2,2	80	13x90	20	LN2503280K20	42,50
□	300	3,2	2,2	60	21x74	24	LN3003260K24	56,50
○	300	3,2	2,2	70	21x84	24	LN3003270K24	49,90
□	300	3,2	2,2	80	13x90	24	LN3003280K24	49,90
○	350	3,5	2,5	70	21x84	28	LN3503570K28	59,20
□	350	3,5	2,5	80	14x92	28	LN3503580K28	59,20

## LAMA CIRCOLARE DI SPALLA PER MULTILAME

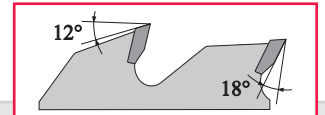
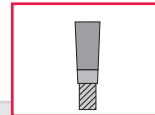

**(GB)** Thick circular saw blade for multirip saw machines

**(F)** Scie circulaire d'épaule pour machine multilames

**(E)** Hoja de sierra espesa para sierras multiples

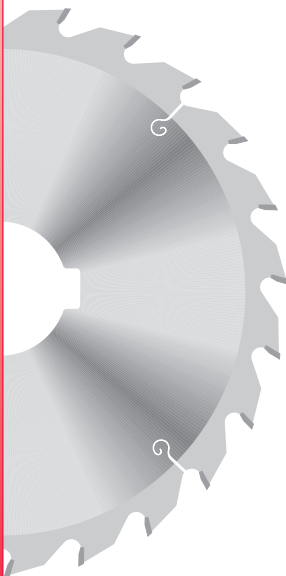

	D	B	b	d		Z	COD	€
○	250	4,0	2,8	70	21x84	20	LN2504070K20	49,50
□	250	4,0	2,8	80	13x90	20	LN2504080K20	49,50
○	250	8,0	6,0	70	21x84	20	LN2508070K20	166,00
□	250	8,0	6,0	80	13x90	20	LN2508080K20	166,00
○	300	4,0	2,8	70	21x84	24	LN3004070K24	55,90
○	300	4,0	2,8	80	13x90	24	LN3004080K24	55,90
○	300	8,0	6,0	70	21x84	24	LN3008070K24	172,00
○	300	8,0	6,0	80	13x90	24	LN3008080K24	172,00
○	350	4,5	3,2	70	21x84	28	LN3504570K28	75,90
○	350	4,5	3,2	80	14x92	28	LN3504580K28	75,90
○	350	8,0	6,0	70	21x84	28	LN3508070K28	188,00
○	350	8,0	6,0	80	14x92	28	LN3508080K28	188,00

GDA  
High-tech tools



# PRODUZIONI SPECIALI

## SPECIAL PRODUCTION

## PRODUCTIONS SPÉCIAUX

## PRODUCCIONES ESPECIALES

*Su richiesta si producono a disegno segmenti, lame circolari e coltelli per Canter per tutti i tipi di macchine (Bongiovanni, EWD, Linck, Mohringer, Primultini, SAB, ecc....)*

*On request we can produce special design of segments, circular saw blades, knives for Canter for all the machines (Bongiovanni, EWD, Linck, Mohringer, Primultini, SAB, ecc....)*

*Sur demande on produit des dessins spéciaux de segments, lames circulaires et couteaux pour Canter pour tous les types de machines (Bongiovanni, EWD, Linck, Mohringer, Primultini, SAB, etc.).*

*Sobre solicitud producimos dibujos especiales de segmentos, hojas de sierra y cuchillas por Canter por todos los tipos de máquinas (Bongiovanni, EWD, Linck, Mohringer, Primultini, SAB, etc.).*

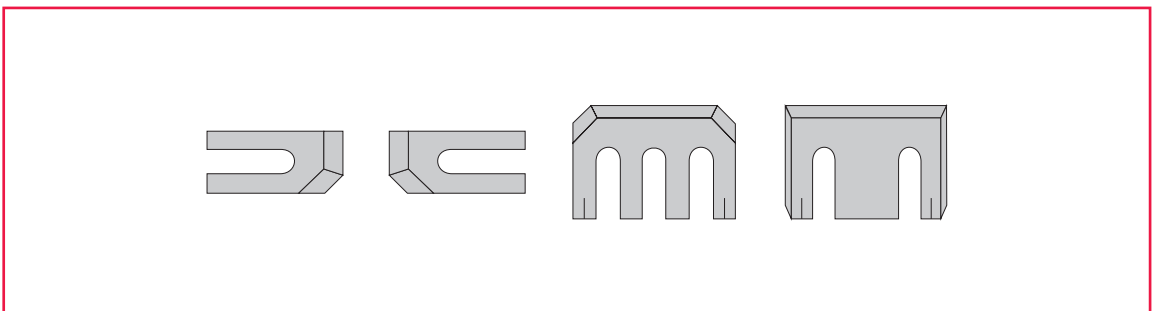
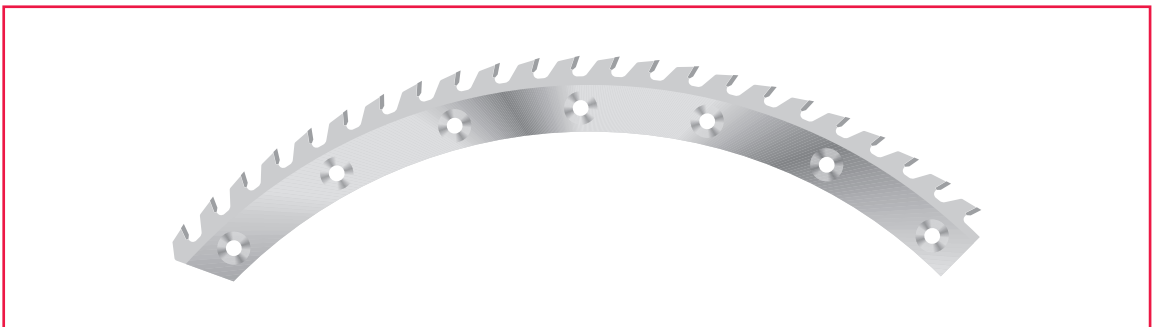
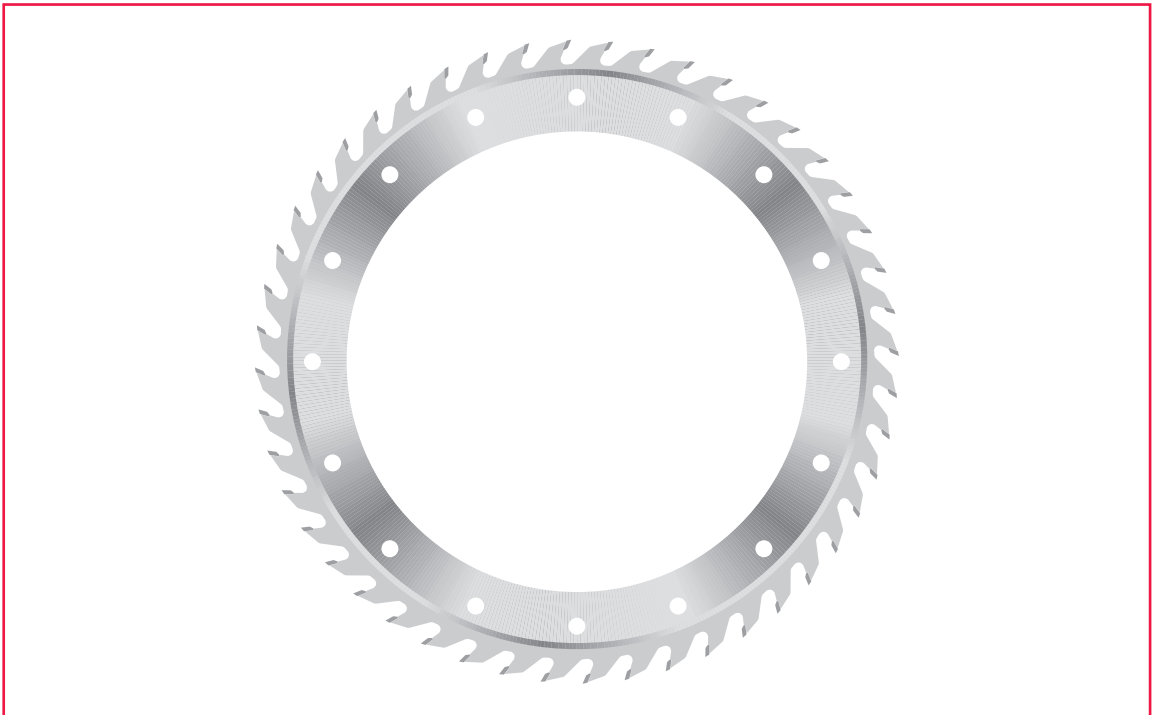

## ANTHON

### Lama / Saw blade / Scie / Hoja de sierra

400x4.4/3.2x60+2 Z=72 TP	LS4004460F72T/B
430x4.4/3.2x60+2 Z=72 TP	LS4304460F72T/B
450x4.4/3.2x60+4 Z=72 TP	LS4504460F72T
530x5.8/4.0x60+2 Z=60 TP	LS5305860F60T/B
400x4.4/3.2x60+2 Z=72 PCD	LSD4004460F72T/B
2/11/85	
730x6.2/4.4x80+2 Z=60 TP	LS7306280F60T/B
2/17/110	

### Incisore / Scorer / Inciseur / Incisor

180x4.3/5.5x20 Z=36	LC180432036
180x5.8/7.0x20 Z=36	LC180582036
180x6.2/7.2x20 Z=36	LC180622036
180x4.4/5.0x20 Z=36 PCD	LCD180442036
180x5.8/6.6x20 Z=36 PCD	LCD180582036

## GABBIANI

### Lama / Saw blade / Scie / Hoja de sierra

300x4.4/3.2x80+PH4 Z=60 TP	LS3004430F60T
300x4.4/3.2x80+PH4 Z=72 TP	LS3004480F72T
320x4.4/3.2x80+PH4 Z=60 TP	LS3204480F60T
350x4.4/3.2x80+PH4 Z=54 TP	LS3504480F54T
350x4.4/3.2x80+PH4 Z=72 TP	LS3504480F72T
350x4.6/3.2x80+PH4 Z=72 TP	LS3504680F72T
355x4.4/3.2x80+PH4 Z=72 TP	LS3554480F72T
380x4.4/3.2x80+PH4 Z=72 TP	LS3804480F72T
400x4.4/3.2x80+PH4 Z=60 TP	LS4004480F60T
400x4.4/3.2x80+PH4 Z=72 TP	LS4004480F72T
400x4.6/3.2x80+PH4 Z=72 TP	LS4004680F72T
420x4.4/3.2x80+PH4 Z=72 TP	LS4204480F72T
450x4.4/3.2x80+PH4 Z=72 TP	LS4504480F72T
350x4.4/3.2x80+PH4 Z=54 A	LS3504480F54
350x4.4/3.2x80+PH4 Z=72 A	LS3504480F72
400x4.4/3.2x80+PH4 Z=36 A	LS4004480F36
400x4.4/3.2x80+PH4 Z=48 A	LS4004480F48
400x4.4/3.2x80+PH4 Z=60 A	LS4004480F60
400x4.4/3.2x80+PH4 Z=72 A	LS4004480F72
400x4.6/3.2x80+PH4 Z=60 A	LS4004680F60
450x4.4/3.2x80+PH4 Z=36 A	LS4504480F36
450x4.4/3.2x80+PH4 Z=54 A	LS4504480F54
350x4.4/3.2x80+PH4 Z=72 TFF	LS3504480F72TFF
350x4.6/3.2x80+PH4 Z=72 TFF	LS3504680F72TFF
400x4.4/3.2x80+PH4 Z=72 TFF	LS4004480F72TFF
350x4.4/3.2x80+PH4 Z=72 TT	LS3504480F72TT
350x4.6/3.2x80+PH4 Z=72 TT	LS3504680F72TT
400x4.4/3.2x80+PH4 Z=72 TT	LS4004480F72TT
350x4.4/3.2x80+PH4 Z=72 PCD	LSD3504480F72T
400x4.4/3.2x80+PH4 Z=72 PCD	LSD4004480F72T
450x4.4/3.2x80+PH4 Z=72 PCD	LSD4504480F72T
2/14/110+2/7/110+4/9/100	

### Incisore / Scorer / Inciseur / Incisor

125x4.0/4.8x20+4+1 Z=20+20	LD125404420F20
125x4.0/4.4x20+4+1 Z=20+20 PCD	LDD125404420F20
4/17/50+1/7/68	
150x4.3/5.5x55+3 Z=36	LC1504355F36
160x4.3/5.5x55+3 Z=36	LC1604355F36
160x4.5/5.7x55+3 Z=36	LC1604555F36
160x4.7/6.0x55+3 Z=36	LC1604755F36
160x4.4/5.0x55+3 Z=36 PCD	LCD1604455F36
180x4.3/5.5x55+3 Z=36	LC1804355F36
3/7/66	
200x4.3/5.5x80+2 Z=36	LC2004380F36
2/14/110	

## GIBEN

### Lama / Saw blade / Scie / Hoja de sierra

320x4.4/3.2x50+8 Z=60 TP	LS3204450F60T
320x4.4/3.2x50+8 Z=72 TP	LS3204450F72T
330x4.4/3.2x50+8 Z=60 TP	LS3304450F60T
350x4.4/3.2x50+8 Z=72 TP	LS3504450F72T
360x4.4/3.2x50+8 Z=72 TP	LS3604450F72T
380x4.4/3.2x50+8 Z=72 TP	LS3804450F72T
320x4.4/3.2x50+8 Z=36 A	LS3204452F36
320x4.4/3.2x50+8 Z=60 PCD	LSD3204450F60T
330x4.4/3.2x50+8 Z=60 PCD	LSD3304450F60T
350x4.4/3.2x50+8 Z=72 PCD	LSD3504450F72T
360x4.4/3.2x50+8 Z=72 PCD	LS3604450F72T
6/12.5/80+2/12.5/80	
320x4.4/3.2x75+3 Z=72 TP	LS3204475F72T
3/13/95	
350x4.4/3.2x75+PH5 Z=54 TP	LS3504475F54T
350x4.4/3.2x75+PH5 Z=72 TP	LS3504475F72T
355x4.4/3.2x75+PH5 Z=72 TP	LS3554475F72T
380x4.4/3.2x75+PH5 Z=72 TP	LS3804475F72T

### Incisore / Scorer / Inciseur / Incisor

125x4.3/5.5x45 Z=24	LC125434524
125x4.0/4.8x45 Z=20+20	LD12540484520
125x4.0/4.8x45 Z=20+20 PCD	LDD12540484520
150x4.3/5.5x45+3 Z=36	LC1504345F36
160x4.3/5.5x45+3 Z=36	LC1604345F36
160x4.5/5.7x45+3 Z=36	LC1604545F36
160x4.4/5.0x45+3 Z=36 PCD	LCD1604445F36
3/11/70	
180x4.3/5.5x50+3 Z=44	LC1804350F44
180x4.4/5.0x50+3 Z=44 PCD	LCD1804450F44
180x4.7/6.0x50+3 Z=36	LC1804750F36
3/12.5/80	
180x5.0/6.2x55 Z=36	LC180505536
190x4.0/5.1x50+2 Z=36	LC1904050F36
2/7/80	
215x4.3/5.5x50+3 Z=42	LC2154350F42
215x4.5/5.7x50+3 Z=42	LC2154550F42
300x4.3/5.5x50+3 Z=32+32	LD30043550F32
300x4.3/5.5x50+3 Z=48	LC3004350F48
300x4.5/5.7x50+3 Z=48	LC3004550F48
215x4.4/5.0x50+3 Z=42 PCD	LCD2154450F42
3/15/80	

## Lama / Saw blade / Scie / Hoja de sierra

400x4.4/3.2x75+4 Z=60 TP	LS4004475F60T
400x4.4/3.2x75+4 Z=72 TP	LS4004475F72T
430x4.4/3.2x75+4 Z=72 TP	LS4304475F72T
430x4.4/3.2x75+4 Z=96 TP	LS4304475F96T
470x4.4/3.2x75+4 Z=72 TP	LS4704475F72T
470x4.4/3.2x75+4 Z=96 TP	LS4704475F96T
350x4.4/3.2x75+PH5 Z=54 A	LS3504475F54
350x4.4/3.2x75+PH5 Z=72 A	LS3504475F72
400x4.4/3.2x75+4 Z=60 A	LS4004475F60
400x4.4/3.2x75+4 Z=72 A	LS4004475F72
400x4.6/3.2x75+4 Z=60 A	LS4004675F60
400x4.4/3.2x75+4 Z=72 TFF	LS4004475F72TFF
430x4.4/3.2x75+4 Z=72 TFF	LS4304475F72TFF
470x4.4/3.2x75+4 Z=72 TFF	LS4704475F72TFF
400x4.4/3.2x75+4 Z=72 TT	LS4004475F72TT
430x4.4/3.2x75+4 Z=72 TT	LS4304475F72TT
470x4.4/3.2x75+4 Z=72 TT	LS4704475F72TT
350x4.4/3.2x75+4 Z=72 PCD	LSD3504475F72T
400x4.4/3.2x75+4 Z=72 PCD	LSD4004475F72T
430x4.4/3.2x75+4 Z=72 PCD	LSD4304475F72T
470x4.4/3.2x75+4 Z=72 PCD	LSD4704475F72T
4/15/105	
550x5.2/3.5x100 Z=72 TP	LS5505210072T
565x5.2/3.5x100 Z=72 TP	LS5655210072T

## Incisore / Scorer / Inciseur / Incisor

# HOLZMA

## Lama / Saw blade / Scie / Hoja de sierra

350x4.4/3.2x60+2 Z=72 TP	LS3504460F72T
380x4.4/3.2x60+2 Z=72 TP	LS3804460F72T
380x4.8/3.5x60+2 Z=72 TP	LS3804860F72T
380x4.8/3.5x60+2 Z=84 TP	LS3804860F84T
380x4.8/3.5x60+2 Z=72 TFF	LS3804860F72TFF
380x4.8/3.5x60+2 Z=72 TT	LS3804860F72TT
350x4.4/3.2x60+2 Z=72 PCD	LSD3504460F72T
380x4.8/3.5x60+2 Z=72 PCD	LSD3804860F72T
2/14/100	
400x4.8/3.5x60+4 Z=72 TP	LS4004860F72T
400x4.8/3.5x60+4 Z=72 TFF	LS4004860F72TFF
400x4.8/3.5x60+4 Z=72 TT	LS4004860F72TT
400x4.8/3.5x60+4 Z=72 PCD	LSD4004860F72T
2/14/100+2/14/125	
420x4.8/3.5x60+2 Z=72 TP	LS4204860F72T
450x4.4/3.2x60+2 Z=72 TP	LS4504460F72T
450x4.8/3.5x60+2 Z=72 TP	LS4504460F72T
420x4.8/3.5x60+2 Z=72 TFF	LS4204860F72TFF
450x4.8/3.5x60+2 Z=72 TFF	LS4504860F72TFF
420x4.8/3.5x60+2 Z=72 TT	LS4204860F72TT
450x4.8/3.5x60+2 Z=72 TT	LS4504860F72TT
420x4.8/3.5x60+2 Z=72 PCD	LSD4204860F72T
450x4.8/3.5x60+2 Z=72 PCD	LSD4504860F72T
2/14/125	
500x4.8/3.5x60+2 Z=60 TP	LS5004860F60T
500x4.8/3.5x60+2 Z=72 TP	LS5004860F72T
500x4.8/3.5x60+2 Z=72 TFF	LS5004860F72TFF
500x4.8/3.5x60+2 Z=72 TT	LS5004860F72TT
500x4.8/3.5x60+2 Z=72 PCD	LSD5004860F72T
2/11/115	
480x4.8/3.5x60+4 Z=72 TP	LS4804860F72T
520x4.8/3.5x60+4 Z=60 TP	LS5204860F60T
540x4.8/3.5x60+4 Z=84 TP	LS5404860F84T
540x5.8/4.0x60+4 Z=60 TP	LS5405860F60T
570x4.8/3.5x60+4 Z=60 TP	LS5704860F60T
570x5.8/4.0x60+4 Z=96 TP	LS5705860F96T
600x5.8/4.0x60+4 Z=60 TP	LS6005860F60T
600x5.8/4.0x60+4 Z=72 TP	LS6005860F72T
480x4.8/3.5x60+4 Z=72 TFF	LS4804860F72TFF
570x4.8/3.5x60+4 Z=60 TFF	
600x5.8/4.0x60+4 Z=72 TFF	LS6005860F72TFF

## Incisore / Scorer / Inciseur / Incisor

180x4.3/5.5x45 Z=36	LC180434536
180x4.4/5.5x45 Z=18+18	LD18044554518
180x4.7/6.0x45 Z=36	LC180474536
200x4.3/5.5x45 Z=36	LC200434536
200x4.7/6.0x45 Z=36	LC200474536
200x5.8/7.0x45 Z=36	LC200584536
200x6.2/7.2x45 Z=36	LC200624536
340x4.4/5.6x45 Z=32+32	LD34044564532
180x4.4/5.0x45 Z=36 PCD	LCD180444536
180x4.8/5.6x45 Z=36 PCD	LCD180484536
200x4.4/5.0x45 Z=36 PCD	LCD200444536
200x4.8/5.6x45 Z=36 PCD	LCD200484536
200x5.8/6.6x45 Z=36 PCD	LCD200584536

## HOLZMA

### Lama / Saw blade / Scie / Hoja de sierra

480x4.8/3.5x60+4 Z=72 TT	LS4804860F72TT
570x4.8/3.5x60+4 Z=60 TT	LS5704860F60TT
600x5.8/4.0x60+4 Z=72 TT	LS6005860F72TT
480x4.8/3.5x60+4 Z=72 PCD	LSD4804860F72T
520x4.8/3.5x60+4 Z=60 PCD	LSD5204860F60T
2/11/115+2/19/120	
670x5.8/4.0x60+4 Z=60 TP	LS6705860F60T
670x5.8/4.0x60+4 Z=72 TP	LS6705860F72T
730x6.2/4.4x60+4 Z=60 TP	LS7306260F60T
730x6.2/4.4x60+4 Z=72 TP	LS7306260F72T
670x5.8/4.0x60+4 Z=72 TFF	LS6705860F72TFF
670x5.8/4.0x60+4 Z=72 TT	LS6705860F72TT
2/19/120+2/11/148	

### Incisore / Scorer / Inciseur / Incisor

## HOMAG

### Lama / Saw blade / Scie / Hoja de sierra

300x4.4/3.2x75 Z=60 TP	LS3004475F60T
350x4.4/3.2x75 Z=54 TP	LS3504475F54T
350x4.4/3.2x75 Z=72 TP	LS3504475F72T
355x4.4/3.2x75 Z=72 TP	LS3554475F72T
400x4.4/3.2x75 Z=60 TP	LS4004475F60T
400x4.4/3.2x75 Z=72 TP	LS4004475F72T
350x4.4/3.2x75 Z=54 A	LS3504475F54
350x4.4/3.2x75 Z=72 A	LS3504475F72
400x4.4/3.2x75 Z=60 A	LS4004475F60
400x4.4/3.2x75 Z=72 A	LS4004475F72
400x4.6/3.2x75 Z=60 A	LS4004675F60
400x4.4/3.2x75 Z=72 TFF	LS4004475F72TFF
400x4.4/3.2x75 Z=72 TT	LS4004475F72TT
350x4.4/3.2x75 Z=72 PCD	LSD3504475F72T
400x4.4/3.2x75 Z=72 PCD	LSD4004475F72T

### Incisore / Scorer / Inciseur / Incisor

125x4.3/5.5x45 Z=24	LC125434524
150x4.3/5.5x45 Z=36	LC1504345F36
180x4.3/5.5x45 Z=36	LC180434536
200x4.3/5.5x45 Z=36	LC200434536
160x4.4/5.0x45 Z=36 PCD	LCD1604445F36
180x4.4/5.0x45 Z=36 PCD	LCD180444536
200x4.4/5.0x45 Z=36 PCD	LCD200444536

## MACMAZZA

### Lama / Saw blade / Scie / Hoja de sierra

350x4.4/3.2x75+3 Z=54 TP	LS3504475F54T
350x4.4/3.2x75+3 Z=72 TP	LS3504475F72T
355x4.4/3.2x75+3 Z=72 TP	LS3554475F72T
380x4.4/3.2x75+3 Z=72 TP	LS3804475F72T
350x4.4/3.2x75+3 Z=54 A	LS3504475F54
350x4.4/3.2x75+3 Z=72 A	LS3504475F72
350x4.4/3.2x75+3 Z=72 PCD	LSD3504475F72T
3/7/100	LS4504475F72T
450x4.4/3.2x75+3 Z=72 TP	
3/7/120	

### Incisore / Scorer / Inciseur / Incisor

160x4.3/5.5x55+3 Z=36	LC1604355F36
280x4.3/5.5x55+3 Z=48	LC2804355F48
280x4.5/5.6x55+3 Z=48	LC2804555F48
160x4.4/5.0x55+3 Z=36 PCD	LCD1604455F36
3/6/84	

## MAYER

### Lama / Saw blade / Scie / Hoja de sierra

300x4.4/3.2x30+PH2 Z=60 TP	LS3004430F60T
300x4.4/3.2x30+PH2 Z=72 TP	LS3004430F72T
350x4.4/3.2x30+PH2 Z=54 TP	LS3504430F54T
350x4.4/3.2x30+PH2 Z=72 TP	LS3504430F72T
400x4.4/3.2x30+2 Z=60 TP	LS4004430F60T
400x4.4/3.2x30+2 Z=72 TP	LS4004430F72T
300x4.4/3.2x30+PH2 Z=48 A	LS3004430F48
300x4.4/3.2x30+PH2 Z=60 A	LS3004430F60
300x4.4/3.2x30+PH2 Z=72 A	LS3004430F72
350x4.4/3.2x30+PH2 Z=54 A	LS3504430F54
350x4.4/3.2x30+PH2 Z=72 A	LS3504430F72
400x4.4/3.2x30+2 Z=60 A	LS4004430F60
400x4.4/3.2x30+2 Z=72 A	LS4004430F72
300x4.4/3.2x30+PH2 Z=60 TFF	LS3004430F60TFF
350x4.4/3.2x30+PH2 Z=72 TFF	LS3504430F72TFF

### Incisore / Scorer / Inciseur / Incisor

125x4.0/4.8x45 Z=20+20	LD12540484520
125x4.3/5.5x45 Z=24	LC125434524
150x4.3/5.5x30 Z=36	LC150433036
125x4.0/4.8x45 Z=20+20 PCD	LDD12540484520

## MAYER

### Lama / Saw blade / Scie / Hoja de sierra

400x4.4/3.2x30+PH2 Z=72 TFF	LS4004430F72TFF
300x4.4/3.2x30+PH2 Z=60 TT	LS3004430F60TT
350x4.4/3.2x30+PH2 Z=72 TT	LS3504430F72TT
400x4.4/3.2x30+PH2 Z=72 TT	LS4004430F72TT
300x4.4/3.2x30+PH2 Z=60 PCD	LSD3004430F60T
350x4.4/3.2x30+PH2 Z=72 PCD	LSD3504430F72T
400x4.4/3.2x30+2 Z=72 PCD	LS4004430F72T
2/10/60	

### Incisore / Scorer / Inciseur / Incisor

## PANHANS

### Lama / Saw blade / Scie / Hoja de sierra

300x4.4/3.2x30+PH2 Z=60 TP	LS3004430F60T
300x4.4/3.2x30+PH2 Z=72 TP	LS3004430F72T
350x4.4/3.2x30+PH2 Z=54 TP	LS3504430F54T
350x4.4/3.2x30+PH2 Z=72 TP	LS3504430F72T
400x4.4/3.2x30+PH2 Z=60 TP	LS4004430F60T
400x4.4/3.2x30+PH2 Z=72 TP	LS4004430F72T
450x4.4/3.2x30+2 Z=72 TP	LS4504430F72T
300x4.4/3.2x30+PH2 Z=48 A	LS3004430F48
300x4.4/3.2x30+PH2 Z=60 A	LS3004430F60
300x4.4/3.2x30+PH2 Z=72 A	LS3004430F72
350x4.4/3.2x30+PH2 Z=54 A	LS3504430F54
350x4.4/3.2x30+PH2 Z=72 A	LS3504430F72
400x4.4/3.2x30+2 Z=60 A	LS4004430F60
400x4.4/3.2x30+2 Z=72 A	LS4004430F72
450x4.4/3.2x30+2 Z=54 A	LS4504430F54
450x4.4/3.2x30+2 Z=72 A	LS4504430F72
300x4.4/3.2x30+PH2 Z=60 TFF	LS3004430F60TFF
350x4.4/3.2x30+PH2 Z=72 TFF	LS3504430F72TFF
400x4.4/3.2x30+PH2 Z=72 TFF	LS4004430F72TFF
300x4.4/3.2x30+PH2 Z=60 TT	LS3004430F60TT
350x4.4/3.2x30+PH2 Z=72 TT	LS3504430F72TT
400x4.4/3.2x30+PH2 Z=72 TT	LS4004430F72TT
300x4.4/3.2x30+PH2 Z=60 PCD	LSD3004430F60T
350x4.4/3.2x30+PH2 Z=72 PCD	LSD3504430F72T
400x4.4/3.2x30+2 Z=72 PCD	LS4004430F72T
2/10/60	

### Incisore / Scorer / Inciseur / Incisor

125x4.3/5.5x20 Z=24	LC125432024
180x4.3/5.5x30 Z=36	LC180433036
200x4.3/5.5x30 Z=36	LC200433036
200x4.4/5.0x30 Z=36 PCD	LCD200443036

## SHELLING

### Lama / Saw blade / Scie / Hoja de sierra

350x4.4/3.2x30+PH2 Z=54 TP	LS3504430F54T
350x4.4/3.2x30+PH2 Z=72 TP	LS3504430F72T
370x4.4/3.2x30+2 Z=72 TP	LS3704430F72T
400x4.4/3.2x30+PH2 Z=60 TP	LS4004430F60T
400x4.4/3.2x30+PH2 Z=72 TP	LS4004430F72T
350x4.4/3.2x30+PH2 Z=54 A	LS3504430F54
350x4.4/3.2x30+PH2 Z=72 A	LS3504430F72
400x4.4/3.2x30+2 Z=60 A	LS4004430F60
400x4.4/3.2x30+2 Z=72 A	LS4004430F72
300x4.4/3.2x30+PH2 Z=60 TFF	LS3004430F60TFF
350x4.4/3.2x30+PH2 Z=72 TFF	LS3504430F72TFF
400x4.4/3.2x30+PH2 Z=72 TFF	LS4004430F72TFF
300x4.4/3.2x30+PH2 Z=60 TT	LS3004430F60TT
350x4.4/3.2x30+PH2 Z=72 TT	LS3504430F72TT
400x4.4/3.2x30+PH2 Z=72 TT	LS4004430F72TT
300x4.4/3.2x30+PH2 Z=60 PCD	LSD3004430F60T
350x4.4/3.2x30+PH2 Z=72 PCD	LSD3504430F72T
370x4.4/3.2x30+2 Z=72 PCD	LSD3704430F72T
400x4.4/3.2x30+2 Z=72 PCD	LS4004430F72T
2/10/60	
450x4.4/3.2x30+2 Z=72 TP	LS4504430F72T
460x4.4/3.2x30+2 Z=72 TP	LS4604430F72T
480x4.4/3.2x30+2 Z=72 TP	LS4804430F72T
500x4.6/3.2x30+2 Z=72 TP	LS5004630F72T

### Incisore / Scorer / Inciseur / Incisor

180x4.3/5.5x20 Z=36	LC180432036
180x6.8/7.8x20 Z=36	LC180682036
200x4.3/5.5x20 Z=36	LC200432036
200x5.0/6.2x20 Z=36	LC200502036
200x6.2/7.2x20 Z=36	LC200622036
180x4.4/5.0x20 Z=36 PCD	LCD180442036
200x4.4/5.0x20 Z=36 PCD	LCD200442036
200x5.0/5.8x20 Z=36 PCD	LCD200502036

## SCHELLING

### Lama / Saw blade / Scie / Hoja de sierra

520x4.8/3.5x30+2 Z=72 TP	LS5204830F72T
530x5.0/3.5x30+2 Z=60 TP	LS5305030F60T
450x4.4/3.2x30+2 Z=54 A	LS4504430F54
450x4.4/3.2x30+2 Z=72 A	LS4504430F72
500x4.6/3.2x30+2 Z=72 A	LS5004630F72
460x4.4/3.2x30+2 Z=72 TFF	LS4604430F72TFF
480x4.4/3.2x30+2 Z=72 TFF	LS4804430F72TFF
520x4.8/3.5x30+2 Z=72 TFF	LS5204830F72TFF
460x4.4/3.2x30+2 Z=72 TT	LS4604430F72TT
480x4.4/3.2x30+2 Z=72 TT	LS4804430F72TT
520x4.8/3.5x30+2 Z=72 TT	LS5204830F72TT
450x4.4/3.2x30+2 Z=72 PCD	LSD4504430F72T
460x4.4/3.2x30+2 Z=72 PCD	LSD4604430F72T
480x4.4/3.2x30+2 Z=72 PCD	LSD4804430F72T

2/13/94  
550x5.2/3.5x40+2 Z=60 TP LS5505240F60T

2/13/122	
620x6.2/4.0x40+4 Z=60 TP	LS6206240F60T
650x6.2/4.0x40+4 Z=60 TP	LS6506240F60T
650x6.2/4.0x40+4 Z=72 TP	LS6506240F72T
680x6.2/4.0x40+4 Z=60 TP	LS6806240F60T
720x6.2/4.4x40+4 Z=60 TP	LS7206240F60T
2/13/114+2/17/140	

### Incisore / Scorer / Inciseur / Incisor

## SCM

### Lama / Saw blade / Scie / Hoja de sierra

300x4.4/3.2x80+PH4 Z=60 TP	LS3004430F60T
300x4.4/3.2x80+PH4 Z=72 TP	LS3004480F72T
350x4.4/3.2x80+PH4 Z=54 TP	LS3504480F54T
350x4.4/3.2x80+PH4 Z=72 TP	LS3504480F72T
350x4.6/3.2x80+PH4 Z=72 TP	LS3504680F72T
355x4.4/3.2x80+PH4 Z=72 TP	LS3554480F72T
380x4.4/3.2x80+PH4 Z=72 TP	LS3804480F72T
400x4.4/3.2x80+PH4 Z=60 TP	LS4004480F60T
400x4.4/3.2x80+PH4 Z=72 TP	LS4004480F72T
400x4.6/3.2x80+PH4 Z=72 TP	LS4004680F72T
350x4.4/3.2x80+PH4 Z=54 A	LS3504480F54
350x4.4/3.2x80+PH4 Z=72 A	LS3504480F72
400x4.4/3.2x80+PH4 Z=36 A	LS4004480F36
400x4.4/3.2x80+PH4 Z=48 A	LS4004480F48
400x4.4/3.2x80+PH4 Z=60 A	LS4004480F60
400x4.4/3.2x80+PH4 Z=72 A	LS4004480F72
400x4.6/3.2x80+PH4 Z=60 A	LS4004680F60
450x4.4/3.2x80+PH4 Z=36 A	LS4504480F36
450x4.4/3.2x80+PH4 Z=54 A	LS4504480F54
350x4.4/3.2x80+PH4 Z=72 TFF	LS3504480F72TFF
350x4.6/3.2x80+PH4 Z=72 TFF	LS3504680F72TFF
400x4.4/3.2x80+PH4 Z=72 TFF	LS4004480F72TFF
350x4.4/3.2x80+PH4 Z=72 TT	LS3504480F72TT
350x4.6/3.2x80+PH4 Z=72 TT	LS3504680F72TT
400x4.4/3.2x80+PH4 Z=72 TT	LS4004480F72TT
350x4.4/3.2x80+PH4 Z=72 PCD	LSD3504480F72T
400x4.4/3.2x80+PH4 Z=72 PCD	LSD4004480F72T
450x4.4/3.2x80+PH4 Z=72 PCD	LSD4504480F72T

2/14/110+2/7/110+4/9/100

### Incisore / Scorer / Inciseur / Incisor

125x4.0/4.8x20+4+1 Z=20+20	LD125404420F20
125x4.0/4.4x20+4+1 Z=20+20 PCD	LDD125404420F20
4/17/50+1/7/68	
150x4.3/5.5x55+3 Z=36	LC1504355F36
160x4.3/5.5x55+3 Z=36	LC1604355F36
160x4.5/5.7x55+3 Z=36	LC1604555F36
160x4.4/5.0x55+3 Z=36 PCD	LCD1604455F36
3/7/66	
200x4.3/5.5x80+2 Z=36	LC2004380F36
2/14/110	

## SELCO

### Lama / Saw blade / Scie / Hoja de sierra

300x4.4/3.2x65+4 Z=60 TP	LS3004465F60T/A
300x4.4/3.2x65+4 Z=72 TP	LS3004465F72T/A
320x4.4/3.2x65+4 Z=60 TP	LS3204465F60T/A
320x4.6/3.2x65+4 Z=60 TP	LS3204665F60T/A
350x4.4/3.2x65+4 Z=72 TP	LS3504465F72T/A
355x4.4/3.2x65+4 Z=72 TP	LS3554465F72T/A
360x4.6/3.2x65+4 Z=72 TP	LS3604665F72T/A

### Incisore / Scorer / Inciseur / Incisor

200x4.3/5.5x65+4 Z=36	LC2004365F36/A
200x4.5/5.7x65+4 Z=36	LC2004565F36/A
200x4.7/6.0x65+4 Z=36	LC2004765F36/A
200x5.0/6.2x65+4 Z=36	LC2005065F36/A
300x4.3/5.5x65+4 Z=72	LC3004365F72/A
300x4.5/5.7x65+4 Z=72	LC3004565F72/A

## Lama / Saw blade / Scie / Hoja de sierra

300x4.4/3.2x65+4 Z=60 PCD	LSD3004465F60T/A
320x4.4/3.2x65+4 Z=60 PCD	LSD3204465F60T/A
350x4.4/3.2x65+4 Z=72 PCD	LSD3504465F72T/A
360x4.4/3.2x65+4 Z=72 PCD	LSD3604465F72T/A
430x4.4/3.2x65+4 Z=72 TP	LS4304465F72T/A
400x4.6/3.2x65+4 Z=72 TP	LS4004665F72T/A
2/9/100+2/9/110	
430x4.8/3.5x70+4 Z=72 TP	LS4304870F72T/A
470x4.4/3.2x70+4 Z=72 TP	LS4704470F72T
520x4.8/3.5x70+4 Z=72 TP	LS5204870F72T
4/11/130	
350x4.4/3.2x80+PH4 Z=54 TP	LS3504480F54T
350x4.4/3.2x80+PH4 Z=72 TP	LS3504480F72T
350x4.6/3.2x80+PH4 Z=72 TP	LS3504680F72T
355x4.4/3.2x80+PH4 Z=72 TP	LS3554480F72T
400x4.4/3.2x80+PH4 Z=60 TP	LS4004480F60T
400x4.4/3.2x80+PH4 Z=72 TP	LS4004480F72T
400x4.6/3.2x80+PH4 Z=72 TP	LS4004680F72T
430x4.4/3.2x80+PH4 Z=72 TP	LS4304480F72T
450x4.4/3.2x80+PH4 Z=72 TP	LS4504480F72T
450x4.6/3.2x80+PH4 Z=72 TP	LS4504680F72T
450x4.8/3.5x80+PH4 Z=72 TP	LS4504880F72T
480x4.8/3.5x80+6 Z=72 TP	LS4804880F72T
480x5.2/3.5x80+6 Z=72 TP	LS4805280F72T
350x4.4/3.2x80+PH4 Z=54 A	LS3504480F54
350x4.4/3.2x80+PH4 Z=72 A	LS3504480F72
400x4.4/3.2x80+PH4 Z=36 A	LS4004480F36
400x4.4/3.2x80+PH4 Z=48 A	LS4004480F48
400x4.4/3.2x80+PH4 Z=60 A	LS4004480F60
400x4.4/3.2x80+PH4 Z=72 A	LS4004480F72
400x4.6/3.2x80+PH4 Z=60 A	LS4004680F60
450x4.4/3.2x80+PH4 Z=36 A	LS4504480F36
450x4.4/3.2x80+PH4 Z=54 A	LS4504480F54
450x4.8/3.5x80+PH4 Z=48 A	LS4504880F48
350x4.4/3.2x80+PH4 Z=72 TFF	LS3504480F72TFF
350x4.6/3.2x80+PH4 Z=72 TFF	LS3504680F72TFF
400x4.4/3.2x80+PH4 Z=72 TFF	LS4004480F72TFF
430x4.4/3.2x80+PH4 Z=72 TFF	LS4304480F72TFF
450x4.8/3.5x80+6 Z=72 TFF	LS4504880F72TFF
480x4.8/3.5x80+6 Z=72 TFF	LS4804880F72TFF
350x4.4/3.2x80+PH4 Z=72 TT	LS3504480F72TT
350x4.6/3.2x80+PH4 Z=72 TT	LS3504680F72TT
400x4.4/3.2x80+PH4 Z=72 TT	LS4004480F72TT
430x4.4/3.2x80+PH4 Z=72 TT	LS4304480F72TT
450x4.8/3.5x80+6 Z=72 TT	LS4504880F72TT
480x4.8/3.5x80+6 Z=72 TT	LS4804880F72TT
350x4.4/3.2x80+PH4 Z=72 PCD	LSD3504480F72T
400x4.4/3.2x80+PH4 Z=72 PCD	LSD4004480F72T
430x4.4/3.2x80+PH4 Z=72 PCD	LSD4304480F72T
450x4.4/3.2x80+PH4 Z=72 PCD	LSD4504480F72T
450x4.8/3.5x80+PH4 Z=72 PCD	LSD4504880F72T
480x4.8/3.5x80+6 Z=72 PCD	LSD4804880F72T
4/19/120+2/9/130	

## Incisore / Scorer / Inciseur / Incisor

300x4.7/6.0x65+4 Z=72	LC3004765F72/A
200x4.4/5.0x65+4 Z=36 PCD	LCD2004465F36/A
200x4.8/5.6x65+4 Z=36 PCD	LCD2004865F36/A
2/9/100+2/9/110	

# LAMA CIRCOLARE PER SEZIONATRICE DENTE ALTERNO

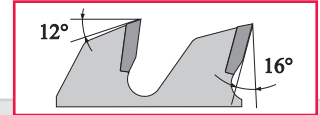
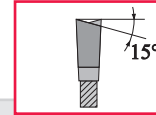

**GB** Circular panel sizing saw blades with alternate bevel tooth

**F** Scie circulaire pour panneaux avec denture alternée

**E** Hoja de sierra para despieadora con diente alterno

I  
M

1  
5  
4

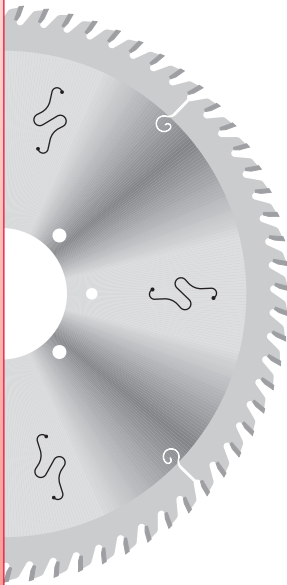

	D	B	b	d	●●●	Z	COD	€
□	300	4,4	3,2	30	PH2	48	LS3004430F48	84,30
○	300	4,4	3,2	30	PH2	60	LS3004430F60	92,10
□	300	4,4	3,2	30	PH2	72	LS3004430F72	107,70
□	320	4,4	3,2	50	GIBEN	36	LS3204450F36	82,50
○	350	4,4	3,2	30	PH2	54	LS3504430F54	90,90
○	350	4,4	3,2	75	PH5	54	LS3504475F54	90,90
○	350	4,4	3,2	80	PH4	54	LS3504480F54	90,90
○	350	4,4	3,2	30	PH2	72	LS3504430F72	103,50
○	350	4,4	3,2	75	PH5	72	LS3504475F72	103,50
○	350	4,4	3,2	80	PH4	72	LS3504480F72	103,50
□	400	4,4	3,2	30	2/10/60	36	LS4004430F36	85,00
□	400	4,4	3,2	80	PH4	36	LS4004480F36	85,00
□	400	4,4	3,2	30	2/10/60	48	LS4004430F48	93,00
□	400	4,4	3,2	80	PH4	48	LS4004480F48	93,00
○	400	4,4	3,2	30	2/10/60	60	LS4004430F60	104,00
○	400	4,4	3,2	75	GIBEN / HOMAG	60	LS4004475F60	104,00
○	400	4,4	3,2	80	PH4	60	LS4004480F60	104,00
○	400	4,4	3,2	30	2/10/60	72	LS4004430F72	117,70
○	400	4,4	3,2	75	GIBEN / HOMAG	72	LS4004475F72	117,70
○	400	4,4	3,2	80	PH4	72	LS4004480F72	117,70
○	400	4,6	3,2	75	GIBEN / HOMAG	60	LS4004675F60	108,20
○	400	4,6	3,2	80	PH4	60	LS4004680F60	108,20
□	450	4,4	3,2	80	PH4	36	LS4504480F36	116,60
□	450	4,4	3,2	30	2/10/60 + SCHELLING	54	LS4504430F54	128,50
□	450	4,4	3,2	80	PH4	54	LS4504480F54	128,50
○	450	4,4	3,2	30	2/10/60 + SCHELLING	72	LS4504430F72	142,80
□	450	4,8	3,5	80	PH4	48	LS4504880F48	147,40
□	500	4,6	3,2	30	2/10/60 + SCHELLING	72	LS5004630F72	172,70



# LAMA CIRCOLARE PER SEZIONATRICE CON DENTE TRAPEZOIDALE PIANO

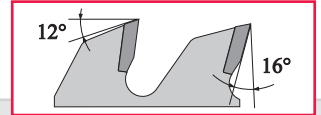
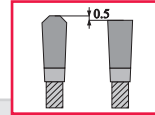

**(GB)** Circular panel sizing saw blades with trapezoidal - flat tooth

**(F)** Scie circulaire pour panneaux avec denture trapézoïdale - plate

**(E)** Hoja de sierra para despiedadora con diente trapezoidal - recto

I  
M

1  
5  
6

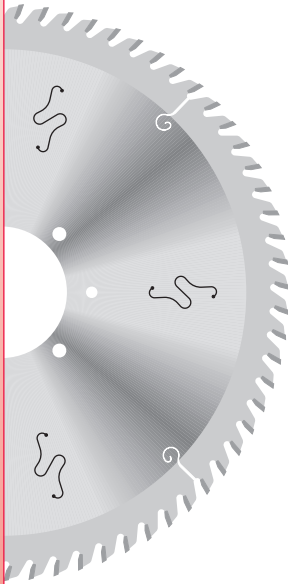

	D	B	b	d	●●●	Z	COD	€
○	300	4,4	3,2	30	PH2	60	LS3004430F60T	94,90
○	300	4,4	3,2	65	SELCO	60	LS3004465F60T/A	94,90
△	300	4,4	3,2	75	HOMAG/MACMAZZA	60	LS300447560T	102,90
○	300	4,4	3,2	80	GABBIANI	60	LS3004480F60T	94,90
□	300	4,4	3,2	30	PH2	72	LS3004430F72T	111,00
□	300	4,4	3,2	65	SELCO	72	LS3004465F72T/A	111,00
○	300	4,4	3,2	80	GABBIANI	72	LS3004480F72T	111,00
□	320	4,4	3,2	50	GIBEN	60	LS3204450F60T	119,60
○	320	4,4	3,2	65	SELCO	60	LS3204465F60T/A	108,20
○	320	4,4	3,2	80	PH4	60	LS3204480F60T	127,40
□	320	4,4	3,2	50	GIBEN	72	LS3204450F72T	127,40
□	320	4,4	3,2	75	GIBEN/MACMAZZA	72	LS3204475F72T	127,40
○	320	4,6	3,2	65	SELCO	60	LS3204665F60T/A	112,50
□	330	4,4	3,2	50	GIBEN	60	LS3304450F60T	119,60
△	350	4,25	3,2	30	PH2	72	LS35042530F72T	117,40
○	350	4,4	3,2	30	PH2	54	LS3504430F54T	93,80
○	350	4,4	3,2	75	PH5	54	LS3504475F54T	93,80
○	350	4,4	3,2	80	PH4	54	LS3504480F54T	93,80
○	350	4,4	3,2	30	PH2	72	LS3504430F72T	106,70
□	350	4,4	3,2	50	GIBEN	72	LS3504450F72T	117,40
□	350	4,4	3,2	60	HOLZMA	72	LS3504460F72T	117,40
□	350	4,4	3,2	65	SELCO	72	LS3504465F72T/A	117,40
○	350	4,4	3,2	75	PH5	72	LS3504475F72T	106,70
○	350	4,4	3,2	80	PH4	72	LS3504480F72T	106,70
□	350	4,6	3,2	80	PH4	72	LS3504680F72T	110,90
□	355	4,4	3,2	30	PH2	72	LS3554430F72T	138,60
□	355	4,4	3,2	65	SELCO	72	LS3554465F72T/A	138,60
△	355	4,4	3,2	75	PH5	72	LS3554475F72T	138,60
○	355	4,4	3,2	80	PH4	72	LS3554480F72T	138,60
□	360	4,4	3,2	50	GIBEN	72	LS3604450F72T	141,30
○	360	4,6	3,2	65	SELCO	72	LS3604665F72T/A	130,90
□	370	4,4	3,2	30	SCHELLING	72	LS3704430F72T	130,90
□	380	4,4	3,2	50	GIBEN	72	LS3804450F72T	133,40
□	380	4,4	3,2	60	HOLZMA	72	LS3804460F72T	121,30
□	380	4,4	3,2	75	PH5	72	LS3804475F72T	133,40
□	380	4,4	3,2	80	PH4	72	LS3804480F72T	133,40
○	380	4,8	3,5	60	HOLZMA	72	LS3804860F72T	146,80
○	380	4,8	3,5	60	HOLZMA	84	LS3804860F84T	160,00
△	400	4,25	3,2	30	2/10/60	72	LS40042530F72T	133,40
○	400	4,4	3,2	30	2/10/60	60	LS4004430F60T	107,20
○	400	4,4	3,2	75	GIBEN / HOMAG	60	LS4004475F60T	107,20
○	400	4,4	3,2	80	PH4	60	LS4004480F60T	107,20
○	400	4,4	3,2	30	2/10/60	72	LS4004430F72T	121,30
□	400	4,4	3,2	60	ANTHON	72	LS4004460F72T/B	133,40
○	400	4,4	3,2	75	GIBEN / HOMAG	72	LS4004475F72T	121,30
○	400	4,4	3,2	80	PH4	72	LS4004480F72T	121,30
□	400	4,6	3,2	65	SELCO	72	LS4004665F72T/A	133,40
○	400	4,6	3,2	80	PH4	72	LS4004680F72T	126,20
○	400	4,8	3,5	60	HOLZMA	72	LS4004860F72T	164,10

# LAMA CIRCOLARE PER SEZIONATRICE CON DENTE TRAPEZOIDALE PIANO

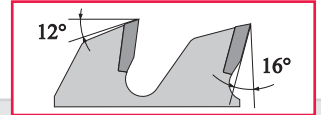
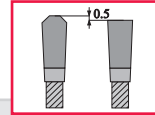

**(GB)** Circular panel sizing saw blades with trapezoidal - flat tooth

**(F)** Scie circulaire pour panneaux avec denture trapézoïdale - plate

**(E)** Hoja de sierra para despidadora con diente trapezoidal - recto

I  
M

1  
5  
6

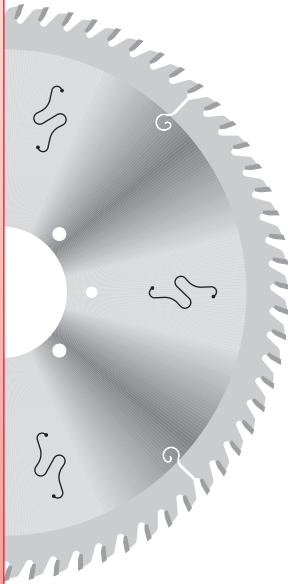

	D	B	b	d	●●●	Z	COD	€
□	420	4,4	3,2	80	PH4	72	LS4204480F72T	152,00
○	420	4,8	3,5	60	HOLZMA	72	LS4204860F72T	164,10
△	430	4,4	3,2	30	2/10/60	72	LS4304430F72T	152,00
□	430	4,4	3,2	60	ANTHON	72	LS4304460F72T/B	152,00
○	430	4,4	3,2	65	SELCO	72	LS4304465F72T/A	159,60
○	430	4,4	3,2	75	GIBEN	72	LS4304475F72T	144,70
○	430	4,4	3,2	80	PH4	72	LS4304480F72T	144,70
○	430	4,4	3,2	75	GIBEN	96	LS4304475F96T	169,50
○	430	4,6	3,2	80	PH4	72	LS4304680F72T	150,50
□	430	4,8	3,5	70	SELCO	72	LS4304870F72T/A	171,60
○	450	4,4	3,2	30	SCHELLING	72	LS4504430F72T	147,30
□	450	4,4	3,2	60	ANTHON / HOLZMA	72	LS4504460F72T	147,30
□	450	4,4	3,2	75	MACMAZZA	72	LS4504475F72T	154,60
□	450	4,4	3,2	80	PH4	72	LS4504480F72T	147,30
○	450	4,6	3,2	80	PH4	72	LS4504680F72T	153,20
○	450	4,8	3,5	60	HOLZMA	72	LS4504860F72T	171,60
○	450	4,8	3,5	80	PH4	72	LS4504880F72T	171,60
○	460	4,4	3,2	30	SCHELLING	72	LS4604430F72T	168,40
□	470	4,4	3,2	70	SELCO	72	LS4704470F72T	176,80
○	470	4,4	3,2	75	GIBEN	72	LS4704475F72T	168,40
○	470	4,4	3,2	75	GIBEN	96	LS4704475F96T	197,60
□	480	4,4	3,2	30	SCHELLING	72	LS4804430F72T	168,40
○	480	4,8	3,5	60	HOLZMA	72	LS4804860F72T	187,80
○	480	4,8	3,5	80	SELCO	72	LS4804880F72T/A	187,80
○	480	5,2	3,5	80	SELCO	72	LS4805280F72T/A	187,80
□	500	4,6	3,2	30	SCHELLING	72	LS5004630F72T	178,10
○	500	4,8	3,5	60	HOLZMA	60	LS5004860F60T	173,50
□	500	4,8	3,5	60	HOLZMA	72	LS5004860F72T	187,80
△	520	4,8	3,5	60	HOLZMA	60	LS5204860F60T	223,50
□	520	4,8	3,5	30	SCHELLING	72	LS5204830F72T	237,80
○	520	4,8	3,5	70	SELCO	72	LS5204870F72T	237,80
□	530	5,0	3,5	30	SCHELLING	60	LS5305030F60T	223,50
□	530	5,8	4,0	60	ANTHON	60	LS5305860F60T/B	258,60
□	540	4,8	3,5	60	HOLZMA	84	LS5404860F84T	233,40
△	540	5,8	4,0	60	HOLZMA	60	LS5405860F60T	258,60
□	550	5,2	3,5	40	SCHELLING	60	LS5505240F60T	221,30
△	550	5,2	3,5	100	GIBEN	72	LS5505210072T	235,80
△	565	5,2	3,5	100	GIBEN	72	LS5655210072T	272,40
△	570	4,8	3,5	60	HOLZMA	60	LS5704860F60T	260,80
□	570	5,8	4,0	60	HOLZMA	96	LS5705860F96T	337,80
□	600	5,8	4,0	60	HOLZMA	60	LS6005860F60T	313,40
□	600	5,8	4,0	60	HOLZMA	72	LS6005860F72T	327,80
□	620	6,2	4,0	40	SCHELLING	60	LS6206240F60T	428,50
□	650	6,2	4,0	40	SCHELLING	60	LS6506240F60T	446,30
□	650	6,2	4,0	40	SCHELLING	72	LS6506240F72T	460,80
□	670	5,8	4,0	60	HOLZMA	60	LS6705860F60T	493,50
□	670	5,8	4,0	60	HOLZMA	72	LS6705860F72T	507,80
□	680	6,2	4,0	40	SCHELLING	60	LS6806240F60T	493,50
□	720	6,2	4,4	40	SCHELLING	60	LS7206240F60T	620,00
□	730	6,2	4,4	60	HOLZMA	60	LS7306260F60T	620,00
□	730	6,2	4,4	60	HOLZMA	72	LS7306260F72T	640,00
□	730	6,2	4,4	80	ANTHON	60	LS7306280F60T/B	620,00

I  
M

1  
5  
7

# LAME CIRCOLARI PER SEZIONATRICE CON DENTE PIANO-PIANO-TRAPEZIO PER LA MASSIMA DURATA DELL'UTENSILE

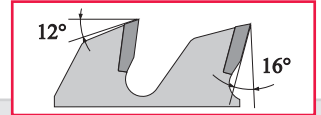
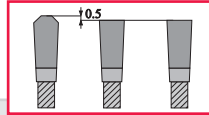

**GB** Circular panel sizing saw blades with teeth flat-flat-triple chip for the maximum tool life

**F** Scie circulaire pour panneaux avec denture trapézoïdale - plate -plate pour la durée de vie maximale

**E** Hoja de sierra para despiezadora con diente trapezoidal - recto - recto para la vida máxima de la herramienta

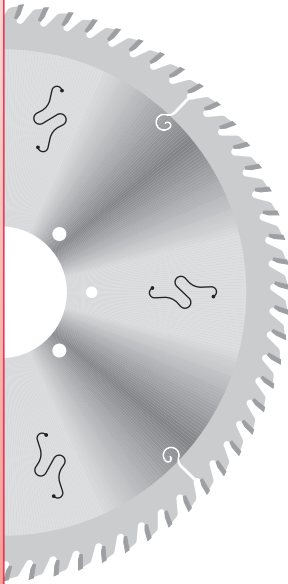

	D	B	b	d	●●●	Z	COD	€
□	300	4,4	3,2	30	PH2	60	LS3004430F60TFF	104,40
□	350	4,4	3,2	30	PH2	72	LS3504430F72TFF	117,40
□	350	4,4	3,2	80	PH4	72	LS3504480F72TFF	117,40
□	350	4,6	3,2	80	PH4	72	LS3504680F72TFF	122,00
□	380	4,8	3,5	60	HOLZMA	72	LS3804860F72TFF	161,50
□	400	4,25	3,2	30	2/10/60	72	LS40042530F72TFF	146,80
□	400	4,4	3,2	30	2/10/60	72	LS4004430F72TFF	133,40
□	400	4,4	3,2	75	GIBEN / HOMAG	72	LS4004475F72TFF	133,40
□	400	4,4	3,2	80	PH4	72	LS4004480F72TFF	133,40
□	400	4,8	3,5	60	HOLZMA	72	LS4004860F72TFF	180,50
□	420	4,8	3,5	60	HOLZMA	72	LS4204860F72TFF	180,50
□	430	4,4	3,2	75	GIBEN	72	LS4304475F72TFF	159,20
□	430	4,4	3,2	80	PH4	72	LS4304480F72TFF	159,20
□	450	4,8	3,5	60	HOLZMA	72	LS4504860F72TFF	188,80
□	450	4,8	3,5	80	PH4	72	LS4504880F72TFF	188,80
□	460	4,4	3,2	30	SCHELLING	72	LS4604430F72TFF	185,30
□	470	4,4	3,2	75	GIBEN	72	LS4704475F72TFF	185,30
□	480	4,4	3,2	30	SCHELLING	72	LS4804430F72TFF	185,30
□	480	4,8	3,5	60	HOLZMA	72	LS4804860F72TFF	206,60
□	480	4,8	3,5	80	SELCO	72	LS4804880F72TFF/A	206,60
□	500	4,8	3,5	60	HOLZMA	72	LS5004860F72TFF	206,60
□	520	4,8	3,5	30	SCHELLING	72	LS5204830F72TFF	261,50
□	570	4,8	3,5	60	HOLZMA	60	LS5704860F60TFF	286,90
□	600	5,8	4,0	60	HOLZMA	72	LS6005860F72TFF	360,60
□	670	5,8	4,0	60	HOLZMA	72	LS6705860F72TFF	558,70

I  
M

1  
5  
8

# LAMA CIRCOLARE PER SEZIONATRICE CON TUTTI I DENTI TRAPEZIO PER LA MASSIMA QUALITA' DI TAGLIO

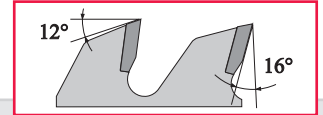
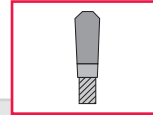

**GB** Circular panel sizing saw blade with trapezoidal tooth for a maximum cut quality

**F** Scie circulaire pour panneaux avec dénature trapézoïdale pour une excellente qualité de coupe

**E** Hoja de sierra para despidadora con dientes trapezoidales para una máxima calidad de corte

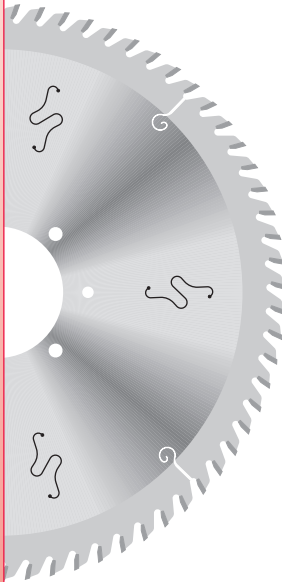

	D	B	b	d	●●●	Z	COD	€
□	300	4,4	3,2	30	PH2	60	LS3004430F60TT	104,40
□	350	4,4	3,2	30	PH2	72	LS3504430F72TT	117,40
□	350	4,4	3,2	80	PH4	72	LS3504480F72TT	117,40
□	350	4,6	3,2	80	PH4	72	LS3504680F72TT	122,00
□	380	4,8	3,5	60	HOLZMA	72	LS3804860F72TT	161,50
□	400	4,25	3,2	30	2/10/60	72	LS40042530F72TT	146,80
□	400	4,4	3,2	30	2/10/60	72	LS4004430F72TT	133,40
□	400	4,4	3,2	75	GIBEN / HOMAG	72	LS4004475F72TT	133,40
□	400	4,4	3,2	80	PH4	72	LS4004480F72TT	133,40
□	400	4,8	3,5	60	HOLZMA	72	LS4004860F72TT	180,50
□	420	4,8	3,5	60	HOLZMA	72	LS4204860F72TT	180,50
□	430	4,4	3,2	75	GIBEN	72	LS4304475F72TT	159,20
□	430	4,4	3,2	80	PH4	72	LS4304480F72TT	159,20
□	450	4,8	3,5	60	HOLZMA	72	LS4504860F72TT	188,80
□	450	4,8	3,5	80	PH4	72	LS4504880F72TT	188,80
□	460	4,4	3,2	30	SCHELLING	72	LS4604430F72TT	185,30
□	470	4,4	3,2	75	GIBEN	72	LS4704475F72TT	185,30
□	480	4,4	3,2	30	SCHELLING	72	LS4804430F72TT	185,30
□	480	4,8	3,5	60	HOLZMA	72	LS4804860F72TT	206,60
□	480	4,8	3,5	80	SELCO	72	LS4804880F72TT/A	206,60
□	500	4,8	3,5	60	HOLZMA	72	LS5004860F72TT	206,60
□	520	4,8	3,5	30	SCHELLING	72	LS5204830F72TT	261,50
□	570	4,8	3,5	60	HOLZMA	60	LS5704860F60TT	286,90
□	600	5,8	4,0	60	HOLZMA	72	LS6005860F72TT	360,60
□	670	5,8	4,0	60	HOLZMA	72	LS6705860F72TT	558,70

# LAMA INCISORE CONICO PER SEZIONATRICE

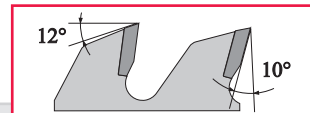
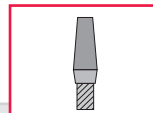

**GB** Dividing scoring saw blade

**F** Inciseur pour le débit de panneaux

**E** Incisor para el despieceado de tableros

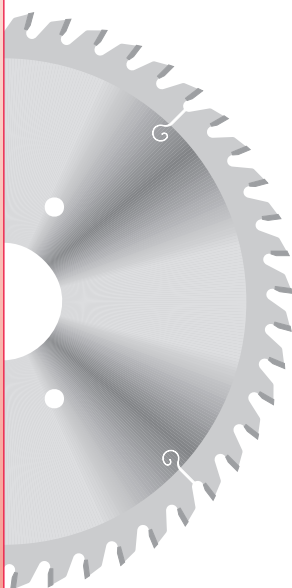

	D	B	b	d	•●•	Z	COD	€
○	80	3,1/4,0	2,2	20		12	LC80312012	38,40
○	90	3,0/4,1	2,2	30		12	LC90303012	40,20
○	100	3,1/4,3	2,2	20		20	LC100312020	40,50
□	100	3,1/4,3	2,2	20		24	LC100312024	51,20
○	110	3,1/4,3	2,2	20		20	LC110312020	41,20
○	120	3,1/4,3	2,2	20		20	LC120312020	40,50
○	120	3,1/4,3	2,2	22		20	LC120312220	40,50
○	120	3,4/4,5	2,2	20		20	LC120342020	42,10
○	125	3,1/4,3	2,2	20		24	LC125312024	41,40
○	125	3,1/4,3	2,2	22		24	LC125312224	41,40
○	125	3,4/4,5	2,2	20		24	LC125342024	43,00
○	125	4,3/5,5	3,2	20		24	LC125432024	48,00
△	125	4,3/5,5	3,2	22		24	LC125432224	54,00
○	125	4,3/5,5	3,2	45		24	LC125434524	48,00
□	140	3,1/4,3	2,2	20		24	LC140312024	60,40
□	140	4,3/5,5	3,2	45	1/8/58	24	LC1404345F24	60,40
○	150	4,3/5,5	3,2	20		24	LC150432024	53,10
○	150	4,3/5,5	3,2	30		24	LC150433024	49,60
○	150	4,3/5,5	3,2	45		24	LC150434524	49,60
△	150	3,1/4,3	2,2	30		36	LC150313036	55,40
○	150	3,4/4,5	2,2	30		36	LC150343036	50,30
○	150	3,9/5,1	2,8	30		36	LC150393036	51,90
○	150	4,3/5,5	3,2	30		36	LC150433036	55,10
□	150	4,3/5,5	3,2	45	GIBEN	36	LC1504345F36	66,10
□	150	4,3/5,5	3,2	55	GABBIANI	36	LC1504355F36	66,10
○	160	4,3/5,5	3,2	20		36	LC160432036	58,60
○	160	4,3/5,5	3,2	30		36	LC160433036	58,60
○	160	4,3/5,5	3,2	45	GIBEN	36	LC1604345F36	60,20
○	160	4,3/5,5	3,2	55	GABBIANI MACMAZZA	36	LC1604355F36	60,20
○	160	4,5/5,7	3,2	45	GIBEN	36	LC1604545F36	61,80
○	160	4,5/5,7	3,2	55	GABBIANI	36	LC1604555F36	61,80
○	160	4,7/6,0	3,5	55	GABBIANI	36	LC1604755F36	66,80
○	180	4,3/5,5	3,2	20		36	LC180432036	68,00
○	180	4,3/5,5	3,2	30	2/10/60	36	LC1804330F36	68,00
○	180	4,3/5,5	3,2	45	HOLZMA	36	LC180434536	68,00
○	180	4,3/5,5	3,2	55	GABBIANI	36	LC1804355F36	69,60
○	180	4,7/6,0	3,5	45	HOLZMA	36	LC180474536	69,60
□	180	4,7/6,0	3,5	50	GIBEN	36	LC1804750F36	84,50
○	180	5,0/6,2	3,5	55	GIBEN	36	LC180505536	69,60
□	180	5,8/7,0	4,0	20	ANTHON	36	LC180582036/B	85,80
□	180	6,2/7,2	4,0	20	ANTHON	36	LC180622036/B	85,80
○	180	6,8/7,8	5,0	20	SHELLING	36	LC180682036	103,50
○	180	4,3/5,5	3,2	50	GIBEN	44	LC1804350F44	73,80
□	190	4,0/5,1	2,8	50	GIBEN	36 A	LC1904050F36	86,00

I  
M

1  
6  
0

# LAMA INCISORE CONICO PER SEZIONATRICE

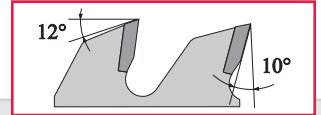
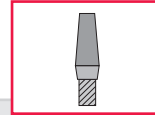

**GB** Dividing scoring saw blade

**F** Inciseur pour le débit de panneaux

**E** Incisor para el despieceado de tableros

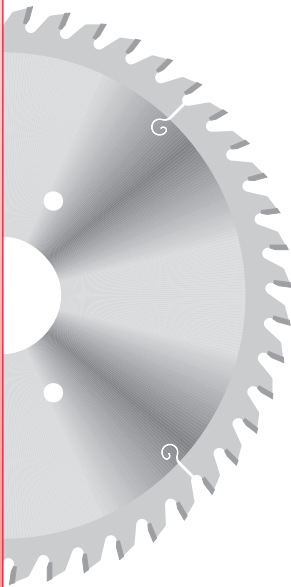

	D	B	b	d	•●•	Z	COD	€
○	200	4,3/5,5	3,2	20		36	LC200432036	68,00
○	200	4,3/5,5	3,2	30	2/10/60	36	LC2004330F36	68,00
○	200	4,3/5,5	3,2	45	HOLZMA	36	LC200434536	68,00
○	200	4,3/5,5	3,2	65	SELCO	36	LC2004365F36/A	69,60
○	200	4,3/5,5	3,2	80	GABBIANI	36	LC2004380F36	69,60
○	200	4,5/5,7	3,2	65	SELCO	36	LC2004565F36/A	71,20
○	200	4,7/6,0	3,5	45	HOLZMA	36	LC200474536	71,20
○	200	4,7/6,0	3,5	65	SELCO	36	LC2004765F36/A	71,20
△	200	5,0/6,2	3,5	20	SHELLING	36	LC200502036	77,00
○	200	5,0/6,2	3,5	65	SELCO	36	LC2005065F36/A	77,00
○	200	5,8/7,0	4,0	45	HOLZMA	36	LC200584536	89,60
□	200	6,2/7,2	4,0	20	SHELLING	36	LC200622036	89,60
□	200	6,2/7,2	4,4	45	HOLZMA	36	LC200624536	98,70
○	215	4,3/5,5	3,2	50	GIBEN	42	LC2154350F42	73,80
○	215	4,5/5,7	3,2	50	GIBEN	42	LC2154550F42	75,30
□	250	4,5/5,7	3,2	30		60	LC250453060	120,00
○	280	4,3/5,5	3,2	55	MACMAZZA	48	LC2804355F48	126,50
□	280	4,5/5,6	3,2	55	MACMAZZA	48	LC2804555F48	126,50
○	300	4,3/5,5	3,2	50	GIBEN	48	LC3004350F48	119,10
○	300	4,3/5,5	3,2	65	SELCO	72	LC3004365F72/A	132,00
○	300	4,5/5,7	3,2	50	GIBEN	48	LC3004550F48	120,50
○	300	4,5/5,7	3,2	65	SELCO	72	LC3004565F72/A	133,60
○	300	4,7/6,0	3,5	65	SELCO	72	LC3004765F72/A	144,40

# LAMA INCISORE REGOLABILE PER SEZIONATRICI CON ANELLI DI REGOLAZIONE

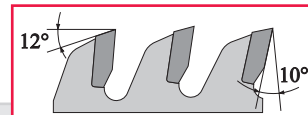

I  
M

**GB** Adjustable dividing scoring saw blade complete with spacers

**F** Inciseur a épaisseur réglable avec les bagues de réglage

**E** Incisor regable para despiezado de tableros con anillos de regulacion

1  
6  
2

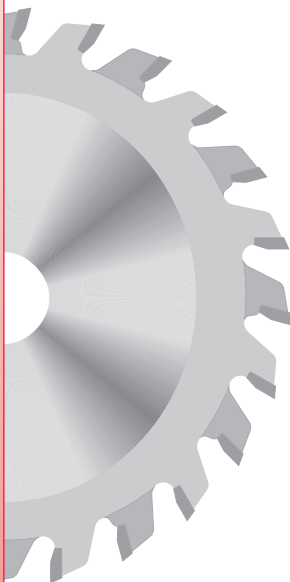

	D	B	b	d	●●●	Z	COD	€
○	70	2,8/3,6	2,2	20		8+8	LD702836208	86,50
○	80	2,8/3,6	2,2	20		10+10	LD8028362010	86,50
○	100	2,8/3,6	2,2	20		10+10	LD10028362010	82,50
○	100	2,8/3,6	2,2	22		10+10	LD10028362210	82,50
○	100	3,1/3,9	2,2	20		10+10	LD10031392010	86,60
○	100	3,1/3,9	2,2	22		10+10	LD10031392210	86,60
○	120	2,8/3,6	2,2	20		12+12	LD12028362012	75,90
○	120	2,8/3,6	2,2	22		12+12	LD12028362212	75,90
○	120	3,1/3,9	2,2	20		12+12	LD12031392012	86,60
○	120	3,1/3,9	2,2	22		12+12	LD12031392212	86,60
○	125	2,8/3,6	2,2	20		12+12	LD12528362012	75,90
○	125	2,8/3,6	2,2	22		12+12	LD12528362212	75,90
○	125	3,1/3,9	2,2	20		12+12	LD12531392012	86,60
○	125	3,1/3,9	2,2	22		12+12	LD12531392212	86,60
○	125	3,1/3,9	2,2	30		12+12	LD12531393012	86,60
○	125	4,0/4,8	2,2	45	GIBEN	20+20	LD12540484520	97,80
□	160	2,8/3,6	2,2	30		18+18	LD16028363018	*
□	160	3,5/4,3	2,2	30		18+18	LD16035433018	*
□	180	2,8/3,6	2,2	30		18+18	LD18028363018	*
□	180	3,5/4,3	2,2	30		18+18	LD18035433018	*
□	180	4,4/5,5	2,2	45	HOLZMA	18+18	LD18044554518	*
□	180	4,8/5,6	2,2	55+3	GABBIANI	28+28	LD180485655F28	*
○	200	4,3/5,2	2,2	20	SCM	30+30	LD20043522030	167,50
□	300	4,3/5,5	1,8	50+3	GIBEN	32+32	LD300435250F32	*
□	340	4,4/5,6	2,5	45	HOLZMA	32+32	LD34044564532	*

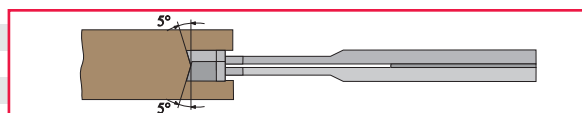

## INCISORE PER ATTACCO RAPIDO SENZA ANELLI SCORING SAW BLADES ADJUSTMENT UNIT RAPIDO WITHOUT RINGS

□	80	2,8/3,6	-	20/6	STRIEBIG	6+6	LD802836206	*
○	120	2,8/3,8	2,2	50+4	ALTENDORF	12+12	LD120283850F12	92,20
□	120	2,8/3,8	2,2	22+2	MARTIN	12+12	LD120283822F12	92,20
□	125	2,8/3,6	2,2	30+12	GRIGGIO	12+12	LD125283630F12	134,80
○	125	4,0/4,4	2,2	20+4+1	GABBIANI	20+20	LD125404420F20	97,80

# GRUPPO DI REGOLAZIONE RAPIDO GDA PER INCISORI DOPPI SENZA USO DI ANELLI

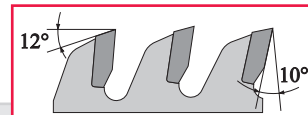

I  
M

**GB** GDA speed regulation unit  
for double scoring saw blades  
without rings

**F** Unité de réglage rapide GDA  
pour inciseur réglable sans bagues

**E** Reglamento unidad GDA Rapido  
de recuento de hojas  
de sierra sin anillos

1  
6  
3

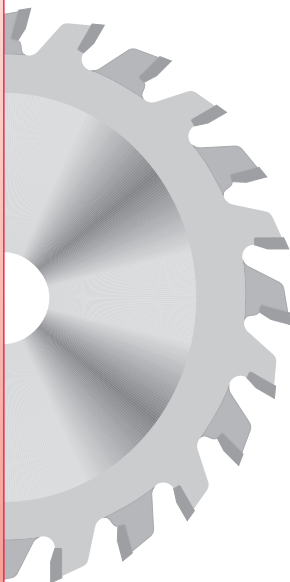

	D	B	b	d	●●●	Z	COD	€
<input type="checkbox"/>	120	2,8/3,6	-	20		12+12	LD12028362012/A	500,00
<input type="checkbox"/>	120	2,8/3,6	-	22		12+12	LD12028362212/A	500,00
<input type="checkbox"/>	125	2,8/3,6	-	20		12+12	LD12528362012/A	500,00
<input type="checkbox"/>	125	2,8/3,6	-	22		12+12	LD12528362212/A	500,00

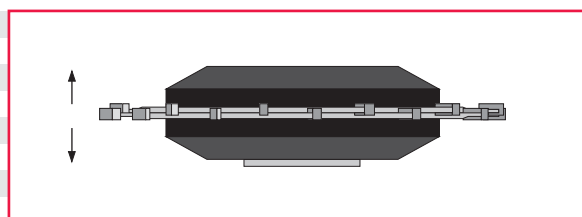

## LAME DI RICAMBIO / SPARE BLADES

<input type="checkbox"/>	120	2,8/3,6	2,2	50	GDA	12+12	LD120283650F12/A	125,00
<input type="checkbox"/>	125	2,8/3,6	2,2	50	GDA	12+12	LD125283650F12/A	125,00

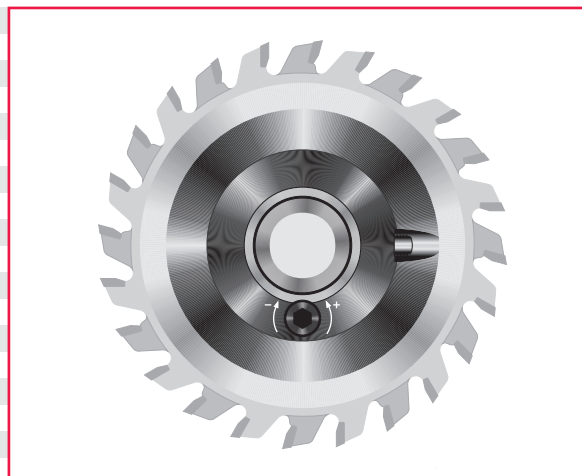



# LAMA INCISORI PER SQUADRATRICI E BORDATRICI

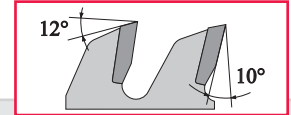
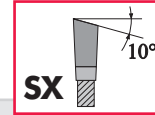
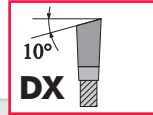
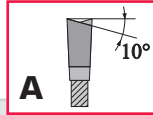

**GB** Scoring saw blade for edge - working and dividing

**F** Inciseur pour plaqueuses déchants et la mise à format de panneaux

**E** Incisor para despiezado de tableros

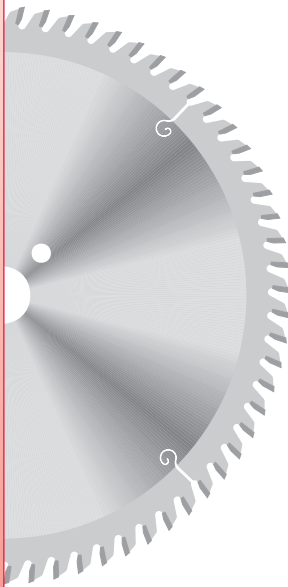

	D	B	b	d	•●•	Z	COD DX-RH	COD SX-LH	€
□	90	3,6	2,5	30		20/15°	LE90363020D	LE90363020S	88,60
□	100	2,6	1,6	32	HOMAG	30 NEG	LE100263230D/A	LE100263230S/A	78,00
□	100/92	3,2	2,2	32		20+20	LE10092323220D	LE10092323220S	*
○	100	3,2	2,2	20		20	LE100322020D	LE100322020S	37,50
○	100	3,2	2,2	32		20	LE100323220D	LE100323220S	37,50
○	115	2,6	1,8	30	STEFANI	24A	LE115263024	LE115263024	45,00
○	115	2,6	1,8	30	STEFANI	24	LE115263024D	LE115263024S	45,00
□	120	3,2	2,2	20		30	LE120322030D	LE120322030S	50,80
○	125	3,2	2,2	20		30	LE125322030D	LE125322030S	42,60
○	125	3,2	2,2	20		40	LE125322040D	LE125322040S	47,90
○	125	3,2	2,2	30		40	LE125323040D	LE125323040S	47,90
○	150	3,2	2,2	30		24	LE150323024D	LE150323024S	42,00
○	150	3,2	2,2	20		36	LE150322036D	LE150322036S	45,80
○	150	3,2	2,2	30		36	LE150323036D	LE150323036S	45,80
○	150	3,2	2,2	55		36	LE150325536D	LE150325536S	45,80
○	150	3,2	2,2	60		36	LE150326036D	LE150326036S	45,80
○	150	3,2	2,2	30		48	LE150323048D	LE150323048S	53,50
○	150	3,2	2,2	55		48	LE150325548D	LE150325548S	53,50
○	150	3,2	2,2	60		48	LE150326048D	LE150326048S	53,50
△	150	3,2	2,2	35+4	STEFANI	48	LE1503235F48D	LE1503235F48S	69,00
○	170	3,2	2,2	20		40	LE170322040D	LE170322040S	48,60
○	170	3,2	2,2	30		40	LE170323040D	LE170323040S	48,60
○	180	3,2	2,2	30		36	LE180323036D	LE180323036S	47,90
○	180	3,2	2,2	40		36	LE180324036D	LE180324036S	47,90
○	180	3,2	2,2	55		36	LE180325536D	LE180325536S	47,90
○	180	3,2	2,2	60		36	LE180326036D	LE180326036S	47,90
○	180	3,2	2,2	30		56	LE180323056D	LE180323056S	57,80
○	180	3,2	2,2	40		56	LE180324056D	LE180324056S	57,80
□	180	3,2	2,2	50+3	LEUCO	42	LE1803250F42D	LE1803250F42S	53,40
□	180	3,2	2,2	65+6	LEUCO	48	LE1803265F48D	LE1803265F48S	71,60
□	180	3,2	2,2	50+3	LEUCO	54	LE1803250F54D	LE1803250F54S	60,00
○	200	3,2	2,2	30		48	LE200323048D	LE200323048S	60,50
○	200	3,2	2,2	40		48	LE200324048D	LE200324048S	60,50
○	200	3,2	2,2	55		48	LE200325548D	LE200325548S	60,50
○	200	3,2	2,2	60		48	LE200326048D	LE200326048S	60,50
○	200	3,2	2,2	70		48	LE200327048D	LE200327048S	60,50
○	200	3,2	2,2	80		48	LE200328048D	LE200328048S	60,50
△	200	3,2	2,2	70		64	LE200327064D	LE200327064S	68,80

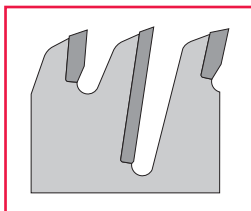

□	125	3,2	2,2	20		20+4	LE1253220204D	LE1253220204S	*
□	125	3,2	2,2	30		20+4	LE1253230204D	LE1253230204S	*
□	140	3,2	2,2	30		24+4	LE1403230244D	LE1403230244S	*
□	150	3,2	2,2	30		28+4	LE1503230284D	LE1503230284S	*
□	170	3,2	2,2	20		24+4	LE1703220244D	LE1703220244S	*
□	170	3,2	2,2	30		24+4	LE1703230244D	LE1703230244S	*

I  
M

## LAMA INCISORI PER CENTRI DI LAVORO

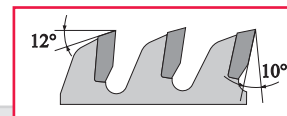
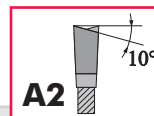
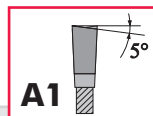
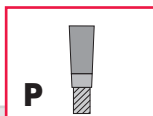

**(GB)** Scoring saw blade for machining centers

**(F)** Inciseur pour centres d'usinage

**(E)** Incisor para centros de mecanizado

1  
6  
6

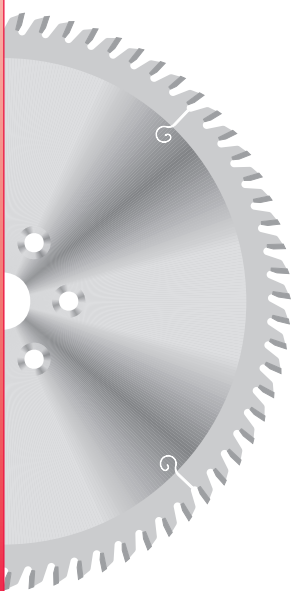

	D	B	b	d	•••	Z	COD	€
○	120	4,0	2,8	35+4+2	BIESSE	30 A1	LX1204035F30	57,50
□	120	3,6	2,8	40+8	HOMAG	36 A2	LX1203640F36	128,50
□	125	3,2	2,2	30+8	HOMAG	36 A2	LX1253230F36	124,00
□	125	4,0	3,0	30+4	HOMAG	24 P	LX1254030F24	118,00
□	140	4,0	2,8	35+4	BIESSE	30 P	LX1404035F30	128,50
○	150	4,0	3,0	35+2	BIESSE	30 A1	LX1504035F30	59,80
□	170	3,2	2,2	30+4	HOMAG	48 A2	LX1703230F48	136,00
□	180	3,2	2,2	30+4	HOMAG	54 A2	LX1803230F54	142,00
○	180	4,0	3,0	35+2	BIESSE	42 A1	LX1804035F42	76,50
□	180	4,0	2,8	35+6	BIESSE	42 A2	LX1804035F42/A	142,00
□	215	4,0	2,8	35+6	BIESSE	50 A2	LX2154035F50	148,00
□	240	3,2	2,2	40+8	HOMAG	34 A2	LX2403240F34	134,00
□	240	3,2	2,2	40+8	HOMAG	54 A2	LX2403240F54	142,00
□	270	3,2	2,4	35+6	BIESSE	48 A2	LX2703235F48	136,00
○	300	3,2	2,2	50+7	BIESSE	24 A2	LN3003250F24	78,20
○	350	3,5	2,5	50+7	BIESSE	28 A2	LN3503550F28	87,20

GDA High-tech tools

I  
M

## LAMA CIRCOLARE PER SOFTFORMING - POSTFORMING

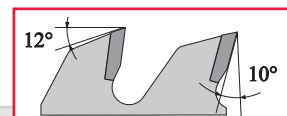
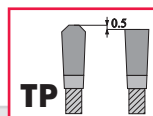
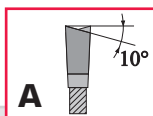

**(GB)** Softforming - postforming saw blade

**(F)** Scie circulaire pour softforming - postforming

**(E)** Hoja de sierra para softforming - postforming

1  
6  
8

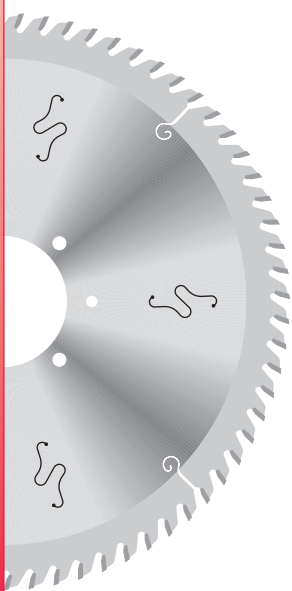

	D	B	b	d	•••	Z	COD	€
□	220	3,35	2,5	30		48 T	LS2203353048T	80,20
□	250	4,55	2,8	30		48 T	LS2504553048T	96,40
□	280	4,6	3,2	55	MACMAZZA	48 A	LS2804655F48	155,50
□	280	4,95	3,5	45		84 A	LS2804954584	155,50
□	300	4,55	3,2	75		60 A	LS3004557560	130,00
□	300	4,55	3,2	30	SCHELLING	72 A	LS3004553072	133,40
□	300	4,55	3,2	65	SELCO	72 AE	LS30045565F72/A	133,40
□	300	4,65	3,2	65	SELCO	72 A	LS30046565F72/A	135,80
□	300	4,60	3,2	50	GIBEN	80 T	LS30046050F80T	140,20
□	300	4,95	3,5	65	SELCO	72 AE	LS30049565F72/A	148,60
□	340	4,95	3,5	45		80 T	LS3404954580T	158,00
□	350	5,00	3,5	65	SELCO	72 AE	LS3505065F72/A	158,00

GDA High-tech tools

○ △ □ \* Ⓢ Ⓣ Ⓤ = vedi pagina 6 / see page 6 / voir page 6 / vease pagina 6

# LAMA CIRCOLARE PER SCANALATURE

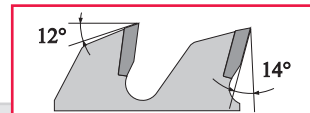
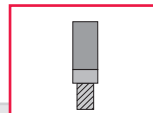

**GB** Grooving circular saw blade

**F** Scie circulaire pour rainures

**E** Hoja de sierra para ranurar

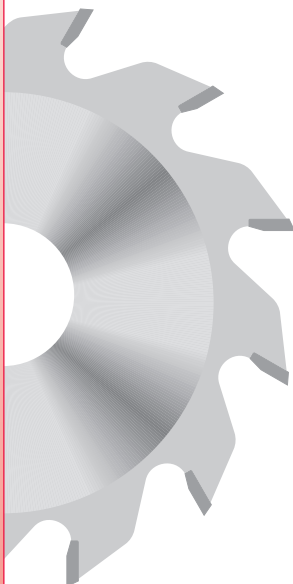

	D	B	b	d	●●●	Z	COD	€
○	125	1,5	1,1	30		12	LI125153012	64,30
○	125	1,8	1,3	30		12	LI125183012	63,00
○	125	2,0	1,4	30		12	LI125203012	49,50
○	125	2,5	1,6	30		12	LI125253012	52,10
○	125	3,0	2,0	30		12	LI125303012	43,80
○	125	3,5	2,5	30		12	LI125353012	48,00
○	125	4,0	2,8	30		12	LI125403012	50,10
○	125	4,5	3,2	30		12	LI125453012	56,20
○	125	5,0	4,0	30		12	LI125503012	60,30
○	125	6,0	4,0	30		12	LI125603012	62,90
○	125	7,0	6,0	30		12	LI125703012	100,60
○	125	8,0	6,0	30		12	LI125803012	110,60
○	125	9,0	6,0	30		12	LI125903012	121,80
○	125	10,0	6,0	30		12	LI1251003012	133,90
○	150	1,5	1,1	30		18	LI150153018	74,00
○	150	1,8	1,3	30		18	LI150183018	72,50
○	150	2,0	1,4	30		18	LI150203018	57,00
○	150	2,5	1,6	30		18	LI150253018	60,00
○	150	3,0	2,0	30		18	LI150303018	50,40
○	150	3,5	2,5	30		18	LI150353018	55,00
○	150	4,0	2,8	30		18	LI150403018	57,80
○	150	5,0	4,0	30		18	LI150503018	69,40
○	150	6,0	4,0	30		18	LI150603018	72,40
○	150	7,0	6,0	30		18	LI150703018	115,80
○	150	8,0	6,0	30		18	LI150803018	127,20
○	150	9,0	6,0	30		18	LI150903018	140,10
○	150	10,0	6,0	30		18	LI1501003018	154,10
○	180	2,0	1,4	30		24	LI180203024	63,80
○	180	2,5	1,6	30		24	LI180253024	67,20
○	180	3,0	2,0	30		24	LI180303024	56,40
○	180	3,5	2,5	30		24	LI180353024	61,50
○	180	4,0	2,8	30		24	LI180403024	64,60
○	180	5,0	4,0	30		24	LI180503024	77,80
○	180	6,0	4,0	30		24	LI180603024	81,20
○	180	7,0	6,0	30		24	LI180703024	129,70
○	180	8,0	6,0	30		24	LI180803024	142,50
○	180	9,0	6,0	30		24	LI180903024	156,90
△	180	10,0	6,0	30		24	LI1801003024	172,60
△	180	2,0	1,4	35		24	LI180203524	71,80
△	180	2,5	1,6	35		24	LI180253524	75,20
△	180	3,0	2,0	35		24	LI180303524	64,40
△	180	3,5	2,5	35		24	LI180353524	69,50
△	180	4,0	2,8	35		24	LI180403524	72,60
△	180	5,0	4,0	35		24	LI180503524	85,80
△	180	6,0	4,0	35		24	LI180603524	89,20
△	180	7,0	6,0	35		24	LI180703524	137,70
△	180	8,0	6,0	35		24	LI180803524	150,50
△	180	9,0	6,0	35		24	LI180903524	164,90
△	180	10,0	6,0	35		24	LI1801003524	180,60
□	200	3,0	2,0	30		32	LI200303032	67,80
□	200	4,0	2,8	30		32	LI200403032	77,50
□	200	5,0	4,0	30		32	LI200503032	93,40
□	200	6,0	4,0	30		32	LI200603032	97,50
□	250	3,0	2,0	30		40	LI250303040	88,50
□	250	4,0	2,8	30		40	LI250403040	89,10
□	250	5,0	4,0	30		40	LI250503040	102,80
□	250	6,0	4,0	30		40	LI250603040	107,30
□	300	3,0	2,0	30	2/10/60	48	LI3003030F48	110,00
□	300	4,0	2,8	30	2/10/60	48	LI3004030F48	121,00
□	300	5,0	4,0	30	2/10/60	48	LI3005030F48	140,00
□	300	6,0	4,0	30	2/10/60	48	LI3006030F48	160,00

I  
M

## LAMA CIRCOLARE PER SEGHE A PENDOLO E SEGHE RADIALI

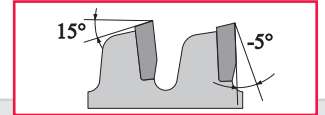
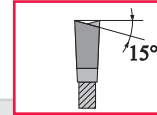

**(GB)** Circular saw blade for pendulum saws,  
radial arm saws

**(F)** Scie circulaire pour scie pendulaire  
et scie a bras radial

**(E)** Hoja de sierra para sierras  
pendulares, sierras de brazo radial

1  
7  
1

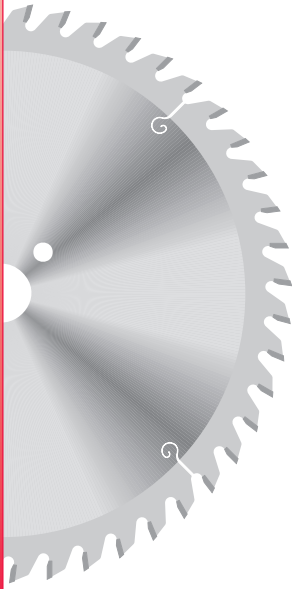

	D	B	b	d	●●●	Z	COD	€
□	300	4,0	2,8	30	2/10/60	36	LR3004030F36N	86,50
△	350	4,0	2,8	30	2/10/60	42	LR3504030F42N	93,80
△	400	4,2	2,8	30	2/10/60	48	LR4004230F48N	102,20
□	450	4,4	3,0	30	2/10/60	54	LR4504430F54N	136,50
△	500	4,4	3,0	30	2/10/60	60	LR5004430F60N	159,80
□	550	4,8	3,2	30	2/10/60	66	LR5504830F66N	214,00
□	600	5,2	3,6	30	2/10/60	72	LR6005230F72N	295,00

GDA  
High-tech tools

I  
M

## LAMA CIRCOLARE PER TRONCATRICI VELOCI E OTTIMIZZATRICI HIGH LINE

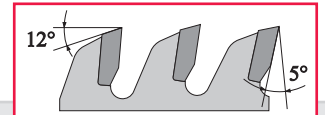
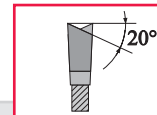

**(GB)** Circular saw blade for fast and optimizing  
cutting-off machines – High Line

**(F)** Lame circulaire pour scies à onglet  
rapides et optimisant – High Line

**(E)** Hoja de sierra para las cortadoras  
veloces y optimisante – High Line

1  
7  
2

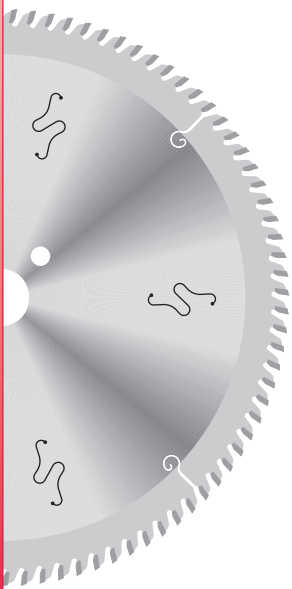

	D	B	b	d	●●●	Z	COD	€
□	400	4,6	3,5	30	2/10/60	120	LX4004630F120	*
□	450	4,6	3,5	30	2/10/60+2/15/63	132	LX4504630F132	*
□	500	4,6	3,5	30	2/10/60+2/15/63	144	LX5004630F144	*
□	520	4,6	3,5	30	2/10/60+2/15/63	144	LX5204630F144	*
□	550	4,6	3,5	120	6/10,2/240	156	LX55046120F156	*
□	600	5,4	4,0	30	2/10/60+2/15/63	172	LX6005430F172	*
□	630	5,4	4,0	30	2/10/60+2/15/63	180	LX6305430F180	*

HIGH  
LINE

GDA  
High-tech tools

# LAMA CIRCOLARE CON TAGLIANTI NEGATIVI PER METALLI LEGGERI

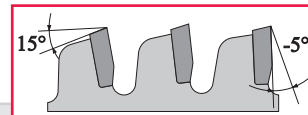
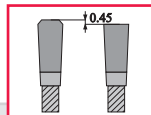

**GB** Light - metal cutting circular saw blade with negative cut

**F** Scie circulaire pour les métaux légers avec denture négative

**E** Hoja de sierra para el corte de metales ligeros con corte negativo

I  
M

1  
7  
4

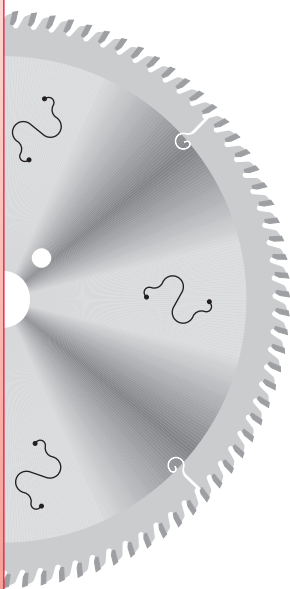

	D	B	b	d	●●●	Z	COD	€
○	200	3,2	2,5	20		64	LA200322064N	68,10
○	250	3,4	2,6	30	2/11/63	60	LA2503430F60N	70,80
○	250	3,4	2,6	32	2/11/63	60	LA2503432F60N	70,80
○	250	3,4	2,6	30	2/11/63	80	LA2503430F80N	68,60
○	250	3,4	2,6	32	2/11/63	80	LA2503432F80N	68,60
□	275	3,4	2,6	30	2/11/63	84	LA2753430F84N	98,80
□	275	3,4	2,6	32	2/11/63	84	LA2753432F84N	98,80
○	300	3,4	2,6	30	2/11/63	72	LA3003430F72N	79,80
○	300	3,4	2,6	32	2/11/63	72	LA3003432F72N	79,80
○	300	3,4	2,6	30	2/11/63	84	LA3003430F84N	88,10
○	300	3,4	2,6	32	2/11/63	84	LA3003432F84N	88,10
○	300	3,4	2,6	30	2/11/63	96	LA3003430F96N	82,90
○	300	3,4	2,6	32	2/11/63	96	LA3003432F96N	82,90
□	320	3,4	2,6	30	2/11/63	96	LA3203430F96N	115,50
□	330	3,4	2,6	30	2/11/63	96	LA3303430F96N	118,80
○	350	3,4	2,6	30	2/11/63	84	LA3503430F84N	96,60
○	350	3,4	2,6	32	2/11/63	84	LA3503432F84N	96,60
○	350	3,4	2,6	30	2/11/63	96	LA3503430F96N	103,80
○	350	3,4	2,6	32	2/11/63	96	LA3503432F96N	103,80
○	350	3,4	2,6	30	2/11/63	108	LA3503430F108N	97,20
○	350	3,4	2,6	32	2/11/63	108	LA3503432F108N	97,20
□	370	3,8	3,0	30	2/11/63	96	LA3703830F96N	142,20
□	380	3,8	3,0	30	2/11/63	96	LA3803830F96N	146,50
○	400	4,0	3,2	30	2/11/63	96	LA4004030F96N	118,80
○	400	4,0	3,2	32	2/11/63	96	LA4004032F96N	118,80
○	400	4,0	3,2	30	2/11/63	108	LA4004030F108N	126,00
○	400	4,0	3,2	32	2/11/63	108	LA4004032F108N	126,00
○	400	4,0	3,2	30	2/11/63	120	LA4004030F120N	133,40
○	400	4,0	3,2	32	2/11/63	120	LA4004032F120N	133,40
△	420	4,0	3,2	30	2/11/63	96	LA4204030F96N	148,90
□	430	4,0	3,2	30	2/11/63	96	LA4304030F96N	175,30
○	450	4,0	3,2	30	2/11/63	96	LA4504030F96N	148,90
○	450	4,0	3,2	32	2/11/63	96	LA4504032F96N	148,90
○	450	4,0	3,2	30	2/11/63	108	LA4504030F108N	155,60
○	450	4,0	3,2	32	2/11/63	108	LA4504032F108N	155,60
○	450	4,0	3,2	30	2/11/63	128	LA4504030F128N	165,70
○	450	4,0	3,2	32	2/11/63	128	LA4504032F128N	165,70
□	450	4,0	3,2	30	2/11/63	140	LA4504030F140N	216,50
○	500	4,6	3,6	30	2/11/63	120	LA5004630F120N	213,10
○	500	4,6	3,6	32	2/11/63	120	LA5004632F120N	213,10
□	500	4,6	3,6	30	2/11/63	140	LA5004630F140N	255,00
□	500	4,6	3,6	30	2/11/63	156	LA5004630F156N	285,00
□	550	4,6	3,6	30	2/11/63	140	LA5504630F140N	308,20
□	550	4,6	3,6	30	2/11/63	172	LA5504630F172N	356,80
□	600	4,6	3,6	30	2/11/63	140	LA6004630F140N	368,30
□	600	4,6	3,6	30	2/11/63	186	LA6004630F186N	418,80
□	650	5,0	4,0	30	2/11/63	160	LA6505030F160N	558,00
□	700	5,0	4,0	30	2/11/63	160	LA7005030F160N	585,00

# LAMA CIRCOLARE CON TAGLIENTI POSITIVI PER METALLI LEGGERI

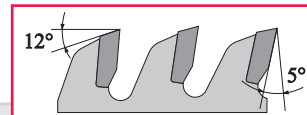
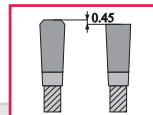

**GB** Light - metal cutting circular saw blade with positive cut

**F** Scie circulaire pour les métaux légers avec denture positive

**E** Hoja de sierra para el corte de metales ligeros con corte positivo

I  
M

1  
7  
6

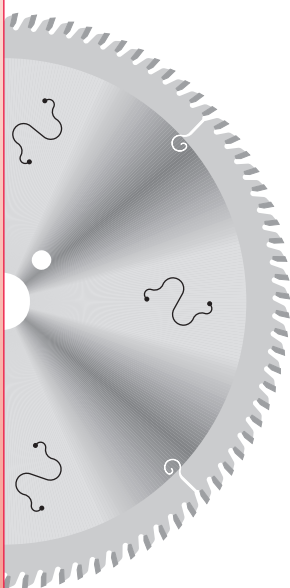

	D	B	b	d	●●●	Z	COD	€
□	200	3,2	2,5	20		48	LA200322048P	67,40
○	200	3,2	2,5	20		64	LA200322064P	68,10
○	250	3,4	2,6	30	2/11/63	60	LA2503430F60P	70,80
○	250	3,4	2,6	32	2/11/63	60	LA2503432F60P	70,80
○	250	3,4	2,6	30	2/11/63	80	LA2503430F80P	68,60
○	250	3,4	2,6	32	2/11/63	80	LA2503432F80P	68,60
□	275	3,4	2,6	30	2/11/63	84	LA2753430F84P	98,80
□	275	3,4	2,6	32	2/11/63	84	LA2753432F84P	98,80
○	300	3,4	2,6	30	2/11/63	72	LA3003430F72P	79,80
○	300	3,4	2,6	32	2/11/63	72	LA3003432F72P	79,80
○	300	3,4	2,6	30	2/11/63	84	LA3003430F84P	88,10
○	300	3,4	2,6	32	2/11/63	84	LA3003432F84P	88,10
○	300	3,4	2,6	30	2/11/63	96	LA3003430F96P	82,90
○	300	3,4	2,6	32	2/11/63	96	LA3003432F96P	82,90
□	320	3,4	2,6	30	2/11/63	96	LA3203430F96P	115,50
□	330	3,4	2,6	30	2/11/63	96	LA3303430F96P	118,80
○	350	3,4	2,6	30	2/11/63	84	LA3503430F84P	96,60
○	350	3,4	2,6	32	2/11/63	84	LA3503432F84P	96,60
○	350	3,4	2,6	30	2/11/63	96	LA3503430F96P	103,80
○	350	3,4	2,6	32	2/11/63	96	LA3503432F96P	103,80
○	350	3,4	2,6	30	2/11/63	108	LA3503430F108P	97,20
○	350	3,4	2,6	32	2/11/63	108	LA3503432F108P	97,20
□	370	3,8	3,0	30	2/11/63	96	LA3703830F96P	142,20
□	380	3,8	3,0	30	2/11/63	96	LA3803830F96P	146,50
○	400	4,0	3,2	30	2/11/63	96	LA4004030F96P	118,80
○	400	4,0	3,2	32	2/11/63	96	LA4004032F96P	118,80
○	400	4,0	3,2	30	2/11/63	108	LA4004030F108P	126,00
○	400	4,0	3,2	32	2/11/63	108	LA4004032F108P	126,00
○	400	4,0	3,2	30	2/11/63	120	LA4004030F120P	133,40
○	400	4,0	3,2	32	2/11/63	120	LA4004032F120P	133,40
△	420	4,0	3,2	30	2/11/63	96	LA4204030F96P	148,90
□	430	4,0	3,2	30	2/11/63	96	LA4304030F96P	175,30
○	450	4,0	3,2	30	2/11/63	96	LA4504030F96P	148,90
○	450	4,0	3,2	32	2/11/63	96	LA4504032F96P	148,90
○	450	4,0	3,2	30	2/11/63	108	LA4504030F108P	155,60
○	450	4,0	3,2	32	2/11/63	108	LA4504032F108P	155,60
○	450	4,0	3,2	30	2/11/63	128	LA4504030F128P	165,70
○	450	4,0	3,2	32	2/11/63	128	LA4504032F128P	165,70
□	450	4,0	3,2	30	2/11/63	140	LA4504030F140P	216,50
○	500	4,6	3,6	30	2/11/63	120	LA5004630F120P	213,10
○	500	4,6	3,6	32	2/11/63	120	LA5004632F120P	213,10
□	500	4,6	3,6	30	2/11/63	140	LA5004630F140P	255,00
□	550	4,6	3,6	30	2/11/63	120	LA5504630F120P	282,00
□	550	4,6	3,6	30	2/11/63	140	LA5504630F140P	308,20
□	600	4,6	3,6	30	2/11/63	120	LA6004630F120P	342,50
□	600	4,6	3,6	30	2/11/63	140	LA6004630F140P	368,30
□	650	5,0	4,0	30	2/11/63	140	LA6505030F140P	527,80
□	700	5,0	4,0	30	2/11/63	140	LA7005030F140P	552,00

1  
M

## LAMA CIRCOLARE PER TAGLIO DI PROFILI IN ALLUMINIO SU TRONCATRICI AUTOMATICHE SINGOLE O DOPPIE - HIGH LINE

**(GB)** Circular saw blade for the cutting of aluminum profiles on automatic cutting-off machines, single or double – High Line

**(F)** Lame circulaire pour la coupe des profils en aluminium sur scies à onglet automatiques, simples ou doubles – High Line

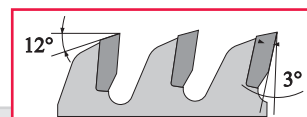
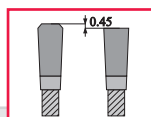

**(E)** Hoja de sierra para el corte de perfiles de aluminio sobre cortadoras automáticas, individuales o dobles - High Line

1  
7  
7

HIGH  
LINE

GDA  
High-tech tools

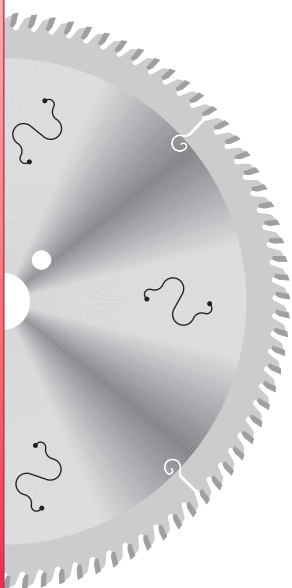

	D	B	b	d	•●•	Z	COD	€
○	300	3,4	2,6	32	2/11/63	96	LA3003432F96P/A	91,20
○	350	3,4	2,6	32	2/11/63	108	LA3503432F108P/A	106,90
□	400	3,8	3,2	32	2/11/63	96	LA4003832F96P/A	130,70
□	450	3,8	3,2	32	2/11/63	96	LA4503832F96P/A	171,20
□	500	3,8	3,2	32	2/11/63	120	LA5003832F120P/A	191,80
□	500	4,6	4,0	32	2/11/63	120	LA5004632F120P/A	234,40

GRAZIE ALLA SPECIALE GEOMETRIA DEL CORPO LAMA, ALLA SILENZIATURA E AD ANGOLI DI AFFILATURA SPECIFICI OTTENIAMO UN'OTTIMA FINITURA E UNA RUMOROSITÀ RIDOTTA AL MINIMO.

THANKS TO THE SPECIAL GEOMETRY OF THE SAW BLADE'S BODY, TO THE NOISELESS SYSTEM AND TO THE SPECIFIC SHARPENING'S ANGLES, WE OBTAIN AN EXCELLENT FINISHED CUT AND A CONSIDERABLE NOISE'S REDUCTION.

GRÂCE À LA GÉOMÉTRIE SPÉCIALE DU CORPS DE LA LAME, AU TAILLAGE SILENCIEUX ET AUX ANGLES D'AFFUTAGE SPÉCIFIQUE, ON OBTIENT UNE EXCELLENTE FINITION ET UN BRUIT RÉDUIT AU MINIMUM.

GRACIAS A LA GEOMETRÍA ESPECIAL DEL CUERPO DE LA HOJA, AL CORTE SILENCIOSO Y A LOS ÁNGULOS D'AFILADO ESPECÍFICO, OBTENEMOS UNA ÓPTIMA FINITURA Y EL RUIDO SE REDUCE AL MÍNIMO.

## LAME CIRCOLARI IN HSS PER IL TAGLIO DI PROFILI SU SERRAMENTI IN PVC

**(GB)** HSS circular saw blades for the profile's cutting on doors and windows in PVC

**(F)** Lames circulaires en HSS pour la coupe de profils sur bâtis en PVC

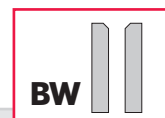
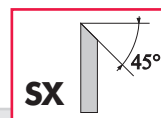
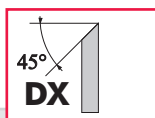

**(E)** Hojas de sierra en HSS por el corte de perfiles sobre carpinterías de PVC

1  
M

1  
7  
8

GDA  
High-tech tools

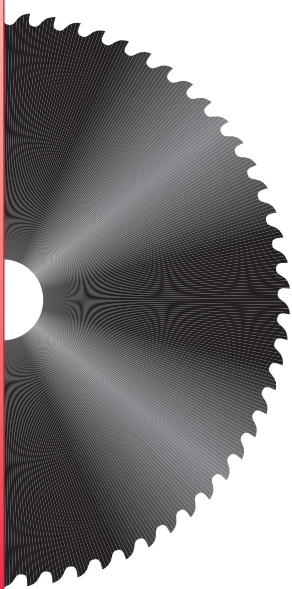

	D	B	b	•●•	Z	COD	€
○	103,4	2,0	32		60 D	LX1034203260D	75,00
○	103,4	2,0	32		60 S	LX1034203260S	75,00
○	225	1,6	32		180 PE	LX2251632180	115,00

LE LAME SONO FORNITE CON UNO SPECIALE TRATTAMENTO ANTIADERENTE

THE SAW BLADES ARE SUPPLIED WITH A SPECIAL ANTI-ADHERENT TREATMENT

LES LAMES CIRCULAIRES SONT FOURNIES AVEC UN TRAITEMENT SPÉCIAL ANTI-ADHÉRENTE

LAS HOJAS DE SIERRA SON ABASTECIAS CON TRATAMIENTO ESPECIAL ANTIADHERENTE

# LAMA CIRCOLARE PER TAGLIO E FRESATURA DI ALLUMINIO

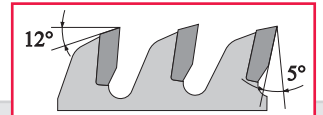
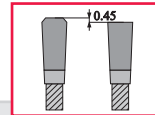

**GB** Circular saw blade for aluminum's cutting and milling

**F** Lames circulaire pour la coupe et le fraisage de l'aluminium

**E** Hoja de sierra por el corte y el fresado de l'aluminio

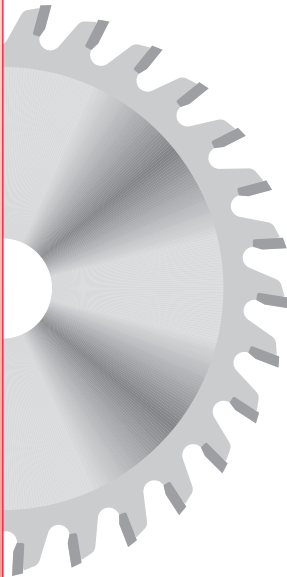

	D	B	b	d	●●●	Z	COD	€
<input type="checkbox"/>	100	3,0	2,2	22		26	LA100302226P	52,60
<input type="checkbox"/>	105	3,0	2,2	22		26	LA105302226P	52,60
<input type="checkbox"/>	115	3,0	2,2	22		30	LA115302230P	54,50
<input type="checkbox"/>	115	4,0	3,0	22		30	LA115402230P	64,00
<input type="checkbox"/>	120	3,0	2,2	22		30	LA120302230P	54,80
<input type="checkbox"/>	125	3,0	2,2	22		30	LA125302230P	54,80
<input type="checkbox"/>	125	4,0	3,0	22		30	LA125402230P	65,00

SU RICHIESTA SI PRODUCONO ALTRE MISURE E FORI SPECIALI  
ON REQUEST WE PRODUCE OTHER MEASURES AND SPECIAL BORES  
SUR DEMANDE ON PRODUIT DES AUTRES MESURES ET DES ALÉSAGES SPÉCIAUX  
SU PREGUNTA PRODUCIMOS OTRAS MEDIDAS Y ORIFICIOS ESPECIALES

ORDINE MINIMO 30 PCS  
MINIMUM ORDER 30 PIECES  
ORDRE MINIMUM DE 30 PIÈCES  
PEDIDO MÍNIMO DE 30 PIEZAS

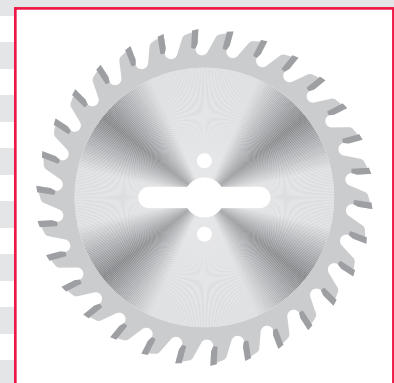
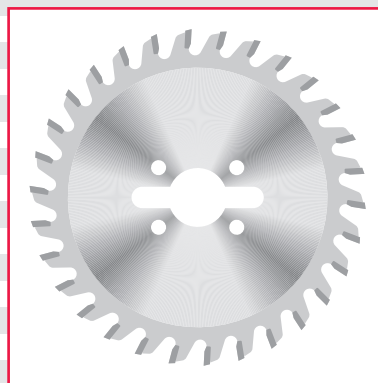



I  
M

1  
8  
0

GDA  
High-tech tools

## LAMA CIRCOLARE PER METALLI FERROSI DRY-CUT

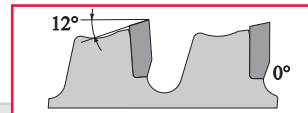
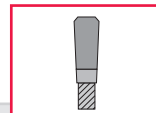

**(GB)** Circular saw blade for dry-cut ferrous metal

**(F)** Scie circulaire pour métaux ferreux dry-cut

**(E)** Hoja de sierra para metales ferrosos dry-cut

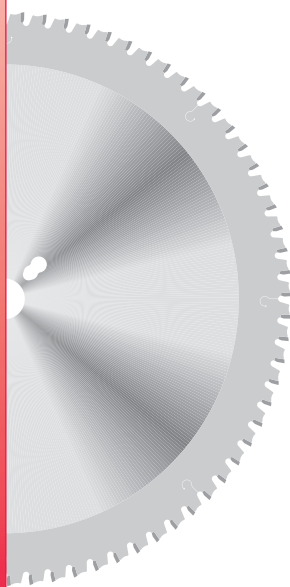

	D	B	b	d	●●●	Z	COD	€
○	150	2.2	1.6	20	2/6/32	30	LG1502220F30	40,80
○	160	2.2	1.6	20	2/6/32	30	LG1602220F30	40,80
○	180	2.2	1.6	30	2/7/42	30	LG1802230F30	42,30
○	190	2.2	1.6	30	2/7/42	38	LG1902230F38	45,50
○	200	2.2	1.6	30	2/7/42	40	LG2002230F40	48,80
○	210	2.2	1.6	30	2/7/42	40	LG2102230F40	48,80
□	216	2.2	1.6	30	2/7/42	40	LG2162230F40	53,60
○	230	2.2	1.6	30	PH2	40	LG2302230F40	53,60
○	250	2.4	1.8	30	PH2	48	LG2502430F48	63,10
□	254	2.4	1.8	25.4	PH2	60	LG25424254F60	77,60
□	300	2.4	1.8	25.4	PH2	60	LG30024254F60	86,20
□	300	2.4	1.8	25.4	PH2	80	LG30024254F80	99,90
○	300	2.4	1.8	30	PH2	60	LG3002430F60	86,20
○	300	2.4	1.8	30	PH2	80	LG3002430F80	99,90
□	305	2.4	1.8	25.4	PH2	80	LG30524254F80	105,00
○	350	2.6	2.0	30	PH2	80	LG3502630F80	115,80
□	355	2.6	2.0	25.4	PH2	80	LG35526254F80	121,60
□	400	3.0	2.2	30	PH2	84	LG4003030F84	139,40

## LAMA CIRCOLARE PER PANNELLI SANDWICH PER COIBENTAZIONE

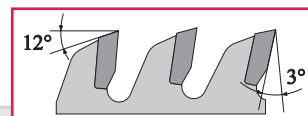
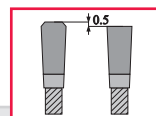

**(GB)** Circular saw blade for sandwich panels

**(F)** Scie circulaire pour panneaux sandwich

**(E)** Hoja de sierra para paneles sanwich para coibentazione

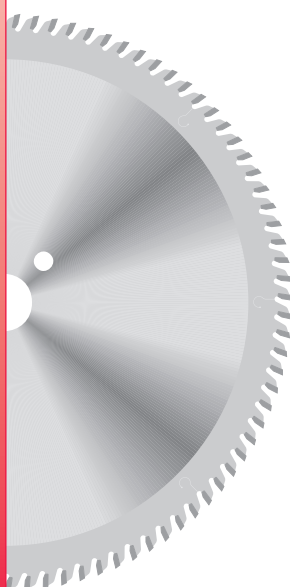

	D	B	b	d	●●●	Z	COD	€
○	250	2,8	2,2	30		80	LG250283080	104,80
○	300	2,8	2,2	30	2/10/60	96	LG3002830F96	122,20
□	330	3,2	2,6	30	2/10/60	96	LG3303230F96	135,60
○	350	3,2	2,6	30	2/10/60	108	LG3503230F108	142,50
□	400	3,4	2,8	30	2/10/60	108	LG4003430F108	163,40
○	450	3,6	3,0	30	2/10/60	120	LG4503630F120	214,60
□	450	3,6	3,0	32		120	LG4503632120	214,60
□	500	3,8	3,2	32		120	LG5003832120	271,20
□	500	3,8	3,2	40		120	LG5003840120	271,20
□	520	4,2	3,6	32		140	LG5204232140	328,00
□	520	4,2	3,6	40		140	LG5204240140	328,00
□	550	4,2	3,6	32		140	LG5504232140	330,00
□	550	4,2	3,6	40		140	LG5504240140	330,00
□	600	4,2	3,6	32		144	LG6004232144	380,00
□	600	4,2	3,6	40		144	LG6004240144	380,00

GDA  
High-tech tools

I  
M

## LAMA CIRCOLARE PER EDILIZIA

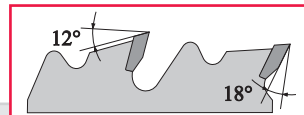
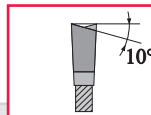

**(GB)** Circular saw blade for building

**(F)** Scie circulaire pour construction

**(E)** Hoja de sierra para construciones

1  
8  
2

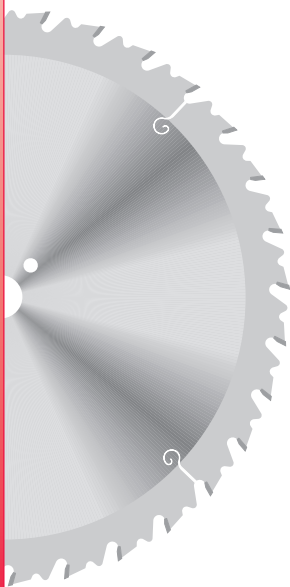

	D	B	b	d	●●●	Z	COD	€
○	250	3,2	2,2	30	PH2	24 LT	LL2503230F24	39,70
○	300	3,2	2,2	30	PH2	28 LT	LL3003230F28	42,90
○	315	3,2	2,2	30	2/10/60	28 LT	LL3153230F28/E	47,50
○	350	3,2	2,2	30	2/10/60	32 LT	LL3503230F32/E	51,40
○	400	3,6	2,5	30	2/10/60	36 LT	LL4003630F36/E	62,90
○	450	4,2	2,8	30	2/10/60	40LT	LL4504230F40	91,50
○	500	4,2	2,8	30	2/10/60	44LT	LL5004230F44	98,70
○	550	4,2	3,0	30	2/10/60	48LT	LL5504230F48/E	135,00
○	600	4,2	3,0	30	2/10/60	48LT	LL6004230F48/E	150,00

GDA  
High-tech tools

I  
M

## LAMA CIRCOLARE PER EDILIZIA

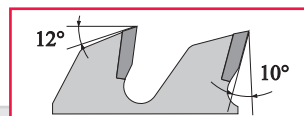
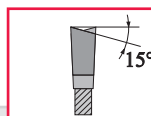

**(GB)** Circular saw blade for building

**(F)** Scie circulaire pour construction

**(E)** Hoja de sierra para construciones

1  
8  
3

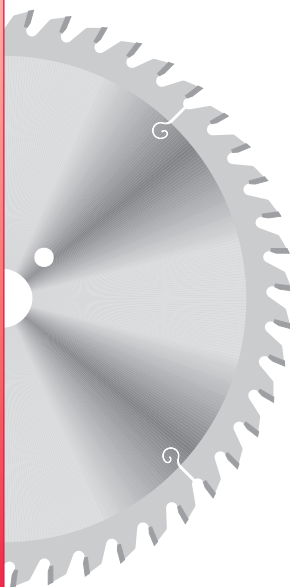

	D	B	b	d	●●●	Z	COD	€
○	250	3,2	2,2	30	PH2	40	LU2503230F40	35,80
○	300	3,2	2,2	30	2/10/60	48	LU3003230F48/E	46,80
○	315	3,2	2,2	30	2/10/60	48	LU3153230F48/E	51,40
○	350	3,2	2,2	30	2/10/60	54	LU3503230F54/E	56,00
○	400	3,6	2,5	30	2/10/60	60	LU4003630F60/E	82,30

GDA  
High-tech tools

# LAMA CIRCOLARE PER MACCHINE PORTATILI

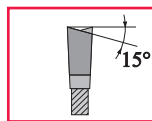
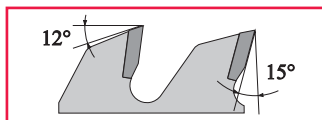
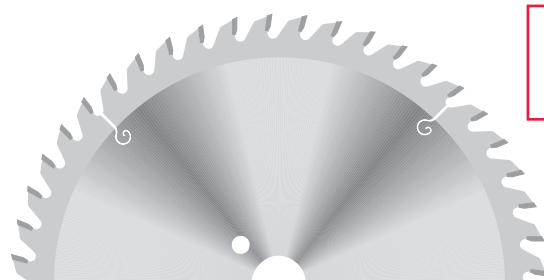

**GB** Circular saw blade for portable machines

**F** Scies circulaires pour machines portables

**E** Hoja de sierra para maquinas portatiles

<b>AEG</b>	D	B	d	Z	COD	€	Z	COD	€	Z	COD	€
HK125A, HK125B	125	2,4	20				20	LP125242020	26,90			
TKS42	130	2,4	20				20	LP130242020	26,90			
HK40	140	2,4	20				20	LP140242020	26,90			
HK45A, HK46S, HK52, HK737, HK46N, HKS52, AHK52, HKS46	150	2,4	20	12	LP150242012	20,80	24	LP150242024	27,70	40	LP150242040	36,40
K55, K55E, K160, HK55	160	2,6	20	12	LP1602620F12	21,10	24	LP1602620F24	27,70	40	LP1602620F40	36,40
HK190, HK65, HK66, HKS65, HKS66, HKSE66, K66	190	2,6	30	12	LP1902630F12	22,50	24	LP1902630F24	29,60	40	LP1902630F40	37,70
HK201	200	2,8	30	24	LP2002830F24	29,10	36	LP2002830F36	36,40	48	LP2002830F48	43,10
HK75, HKS75	210	2,8	30	24	LP2102830F24	31,00	36	LP2102830F36	39,20	48	LP2102830F48	46,80
HKS75, HKS35	230	2,8	30	24	LP2302830F24	36,80	36	LP2302830F36	43,90	48	LP2302830F48	52,00
HK240	240	2,8	30	24	LP2402830F24	37,00	36	LP2402830F36	43,90	48	LP2402830F48	51,60
<b>ATLAS COPCO</b>	D	B	d	Z	COD	€	Z	COD	€	Z	COD	€
TKS42	130	2,4	20				20	LP130242020	26,90			
K55S, K55SE	160	2,4	20	12	LP1602620F12	21,10	24	LP1602620F24	27,70	40	LP1602620F40	36,40
K66S, K66SE	190	2,6	30	12	LP1902630F12	22,50	24	LP1902630F24	29,60	40	LP1902630F40	37,70
TKS75	210	2,8	30	24	LP2102830F24	31,00	36	LP2102830F36	39,20	48	LP2102830F48	46,80
HKS85	230	2,8	30	24	LP2302830F24	35,80	36	LP2302830F36	43,90	48	LP2302830F48	52,00
<b>BLACK &amp; DECKER</b>	D	B	d	Z	COD	€	Z	COD	€	Z	COD	€
BD855, KS855, U336, U975, U976	160	2,6	16	12	LP160261612	21,10	24	LP160261624	27,70	40	LP160261640	36,40
SEC718, BD865E, KS865, P37-03, P37-05, DN229, DN59, DN820, HD1000, HD2062, SR300, SR362E, HD100, BD229	184	2,6	16				24	LP184261624	29,60	40	LP184261640	37,70
DN800, SEC818, DN810, SR700, BD800	210	2,8	30	24	LP2102830F24	31,00	36	LP2102830F36	39,20	48	LP2102830F48	46,80
P39-02, SEC918	235	2,8	30	24	LP2352830F24	37,00	36	LP2352830F36	43,90	48	LP2352830F48	51,60
<b>BOSCH</b>	D	B	d	Z	COD	€	Z	COD	€	Z	COD	€
1551, 1559	140	2,4	20				20	LP140242020	26,90			
GKS12V, PKS46, S1, S33, GKS46	150	2,4	16				24	LP150241624	27,70			
GKS54, PKS54	160	2,6	16	12	LP160261612	21,10	24	LP160261624	26,70	40	LP160261640	36,40
GKS55, 1552, 1556, 1563	170	2,6	30				24	LP1702630F24	29,60	40	LP1702630F40	37,70
1550, 1557, 1560	180	2,6	30	12	LP1802630F12	21,90	24	LP1802630F24	29,60	40	LP1802630F40	37,70
P30, P300, PKS65	190	2,6	16	12	LP1902616F12	22,50	24	LP1902616F24	29,60	40	LP1902616F40	37,70
PKS66, GKS65, GKS66, GKS68, 0051, 1564, 1553	190	2,6	30	12	LP1902630F12	22,50	24	LP1902630F24	29,60	40	LP1902630F40	37,70
1561	200	2,8	30	24	LP2002830F24	29,10	36	LP2002830F36	36,40	48	LP2002830F48	43,10
1554, 1558, 1565, GKS75S	210	2,8	30	24	LP2102830F24	31,00	36	LP2102830F36	39,20	48	LP2102830F48	46,80
0052, 1562, 1566, GKS85S	230	2,8	30	24	LP2302830F24	38,80	36	LP2302830F36	43,90	48	LP2302830F48	52,00
1555	240	2,8	30	24	LP2402830F24	37,00	36	LP2402830F36	43,90	48	LP2402830F48	51,60
<b>CASALS</b>	D	B	d	Z	COD	€	Z	COD	€	Z	COD	€
BSC150, VSC50	150	2,4	20	12	LP150242012	20,80	24	LP150242024	27,70	40	LP150242040	36,40
SC210, VSC70	210	2,8	30	24	LP2102830F24	31,00	36	LP2102830F36	39,20	48	LP2102830F48	46,80
SC230	230	2,8	30	24	LP2302830F24	35,80	36	LP2302830F36	43,90	48	LP2302830F48	52,00
<b>DeWALT</b>	D	B	d	Z	COD	€	Z	COD	€	Z	COD	€
DW351	150	2,4	20	12	LP150242012	20,80	24	LP150242024	27,70	40	LP150242040	36,40
DW62	184	2,6	30				24	LP184263024	29,60	40	LP184263040	37,70
DW65, DW365	190	2,6	30	12	LP1902630F12	22,50	24	LP1902630F24	29,60	40	LP1902630F40	37,70
DW700, DW701, DW707	216	2,8	30	24	LP216283024	34,50	48	LP216283048	49,90	64	LP216283064	59,30
DW383	235	2,8	30	24	LP2352830F24	37,00	36	LP2352830F36	43,90	48	LP2352830F48	51,60
DW86	240	2,8	30	24	LP2402830F24	37,00	36	LP2402830F36	43,90	48	LP2402830F48	51,60
DW250, DW252, DW320, 1251, 1501, 1503, DW710, DW125, DW150, DW720, DW742	250	2,8	30				40	LU2503230F40	35,80	60	LU2503230F60	42,90
<b>ELEKTRA - BECKUM</b>	D	B	d	Z	COD	€	Z	COD	€	Z	COD	€
KS250, KGS250, GKS300	250	3,2	30				40	LU2503230F40	35,80	60	LU2503230F60	42,90
<b>ELU</b>	D	B	d	Z	COD	€	Z	COD	€	Z	COD	€
MH151	150	2,4	20	12	LP150242012	20,80	24	LP150242024	27,70	40	LP150242040	36,40
MH155, MH55	170	2,6	30				24	LP1702630F24	29,60	40	LP1702630F40	37,70
MH65	180	2,6	30	12	LP1802630F12	21,90	24	LP1802630F24	29,60	40	LP1802630F40	37,70
MH165, 265	190	2,6	30	12	LP1902630F12	22,50	24	LP1902630F24	29,60	40	LP1902630F40	37,70
MH182, MH30, MH82	210	2,8	30	24	LP2102830F24	31,00	36	LP2102830F36	39,20	48	LP2102830F48	46,80
PS174, PS274	216	2,8	30	24	LP216283024	34,50	48	LP216283048	49,90	64	LP216283064	59,30
MH85	240	2,8	30	24	LP2402830F24	37,00	36	LP2402830F36	43,90	48	LP2402830F48	51,60
TKS171, 170, 171, 172, 173	250	3,2	30				40	LU2503230F40	35,80	60	LU2503230F60	42,90

# LAMA CIRCOLARE PER MACCHINE PORTATILI

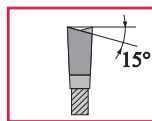
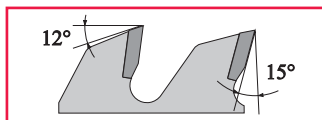
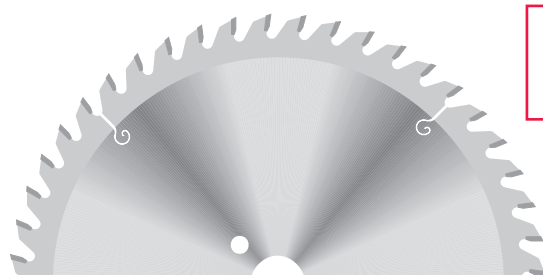

**GB** Circular saw blade for portable machines

**F** Scies circulaires pour machines portables

**E** Hoja de sierra para maquinas portatiles

FEIN	D	B	d	Z	COD	€	Z	COD	€	Z	COD	€
SSK646	150	2,4	20	12	LP150242012	20,80	24	LP150242024	27,70	40	LP150242040	36,40
SSK660	160	2,6	20	12	LP1602620F12	21,10	24	LP1602620F24	27,70	40	LP1602620F40	36,40
SSK661	210	2,8	30	24	LP2102830F24	31,00	36	LP2102830F36	39,20	48	LP2102830F48	46,80
FELISATTI	D	B	d	Z	COD	€	Z	COD	€	Z	COD	€
TP751	150	2,4	20	12	LP150242012	20,80	24	LP150242024	27,70	40	LP150242040	36,40
TP765, TP766	190	2,6	30	12	LP1902630F12	22,50	24	LP1902630F24	29,60	40	LP1902630F40	37,70
FESTO	D	B	d	Z	COD	€	Z	COD	€	Z	COD	€
AUF35, S4	125	2,4	20				20	LP125242020	26,90			
ATF55, AP55	160	2,6	20	12	LP1602620F12	21,10	24	LP1602620F24	27,70	40	LP1602620F40	36,40
AU50, AUP50, AAU	160	2,6	30				24	LP1602630F24	27,70	40	LP1602630F40	36,40
AT5E, AUT42S, AU42S, AX150LA, AXT55	170	2,6	30				24	LP1702630F24	29,60	40	LP1702630F40	37,70
AU55S, AU60P, AU60S, AUT60S	180	2,6	30	12	LP1802630F12	21,90	24	LP1802630F24	29,60	40	LP1802630F40	37,70
AD65, AU65S, AXP65, AP68E, AUT65S	200	2,8	30	24	LP2002830F24	29,10	36	LP2002830F36	36,40	48	LP2002830F48	43,10
AU77S	220	2,8	30	24	LP2202830F24	32,30	36	LP2202830F36	40,40	48	LP2202830F48	47,20
AXP85, AP88E, AP85E	240	2,8	30	24	LP2402830F24	37,00	36	LP2402830F36	43,90	48	LP2402830F48	51,60
AD85-1, AE85	250	3,2	30				40	LU2503230F40	35,80	60	LU2503230F60	42,90
FLOTTJET	D	B	d	Z	COD	€	Z	COD	€	Z	COD	€
1011, 2011, 3011	250	3,2	30				40	LU2503230F40	35,80	60	LU2503230F60	42,90
FREUD	D	B	d	Z	COD	€	Z	COD	€	Z	COD	€
FCS184	184	2,6	30	24	LP184263024	29,60				40	LP184263040	37,70
FTR250T	250	3,2	30				40	LU2503230F40	35,80	60	LU2503230F60	42,90
HAFFNER	D	B	d	Z	COD	€	Z	COD	€	Z	COD	€
KSU105	125	2,4	20				20	LP125242020	26,90			
KSU50	160	2,6	20	12	LP1602620F12	21,10	24	LP1602620F24	27,70	40	LP1602620F40	36,40
KSU110	170	2,6	30				24	LP1702630F24	29,60	40	LP1702630F40	37,70
KSU60	180	2,6	20				24	LP1802620F24	29,60	40	LP1802620F40	37,70
KSU113	180	2,6	30	12	LP1802630F12	21,90	24	LP1802630F24	29,60	40	LP1802630F40	37,70
AKS	200	2,8	30	24	LP2002830F24	29,10	36	LP2002830F36	36,40	48	LP2002830F48	43,10
KS75, KL177, KL178, KSU118	210	2,8	30	24	LP2102830F24	31,00	36	LP2102830F36	39,20	48	LP2102830F48	46,80
KS75, KL177, KL178, KSU118	220	2,8	30	24	LP2202830F24	32,30	36	LP2202830F36	40,40	48	LP2202830F48	47,20
KL176, KS85, KSU85, SP187	235	2,8	30	24	LP2352830F24	37,00	36	LP2352830F36	43,90	48	LP2352830F48	51,60
SP196, Sp197, AKS, SP189, TGS161, TGS162, TGS163, GS165, GS166, GS1, 2W, 2D, SP195, TGS198, GS130	250	3,2	30				40	LU2503230F40	35,80	60	LU2503230F60	42,90
HITACHI	D	B	d	Z	COD	€	Z	COD	€	Z	COD	€
C5Y	125	2,4	20				20	LP125242020	26,90			
C5, FC5, FC5SA	150	2,4	20	12	LP150242012	20,80	24	LP150242024	27,70	40	LP150242040	36,40
C6DA, FC6DA	160	2,6	20	12	LP1602620F12	21,10	24	LP1602620F24	27,70	40	LP1602620F40	36,40
C6SA, PSU6	170	2,6	30				24	LP1702630F24	29,60	40	LP1702630F40	37,70
FC7SA, PSM-7, PSU7	190	2,6	30	12	LP1902630F12	22,50	24	LP1902630F24	29,60	40	LP1902630F40	37,70
C8U, C8FA, PSM-8, PSU-8	210	2,8	30	24	LP2102830F24	31,00	36	LP2102830F36	39,20	48	LP2102830F48	46,80
C8FC	216	2,8	30	24	LP216283024	34,50	48	LP216283048	49,90	64	LP216283064	59,30
C9U, PSM9, PSU9	235	2,8	30	24	LP2352830F24	37,00	36	LP2352830F36	43,90	48	LP2352830F48	51,60
HOLZ - HER	D	B	d	Z	COD	€	Z	COD	€	Z	COD	€
DERBY, MOSQUITO, 2110, 2111, 2171	130	2,4	20				20	LP130242020	26,90			
2260, 2270, 2103, 2104, 2105	140	2,4	20				20	LP140242020	26,90			
2106, 2107, 2108, HKU50/264	160	2,6	20	12	LP1602620F12	21,10	24	LP1602620F24	27,70	40	LP1602620F40	36,40
1563, 2115, 2266, 2271, 2281	170	2,6	30				24	LP1702630F24	29,60	40	LP1702630F40	37,70
HKU55, 2112, 2272, 2291	180	2,6	30	12	LP1802630F12	21,90	24	LP1802630F24	29,60	40	LP1802630F40	37,70
2114, 2116, 2117, 2119, 2126, 2269, 2282	190	2,6	30	12	LP1902630F12	22,50	24	LP1902630F24	29,60	40	LP1902630F40	37,70
HK201, 2113, 2292, 2555	200	2,8	30	24	LP2002830F24	29,10	36	LP2002830F36	36,40	48	LP2002830F48	43,10
PKS267, 2267, 2284	210	2,8	30	24	LP2102830F24	31,00	36	LP2102830F36	39,20	48	LP2102830F48	46,80
HKU75, 2274, 2279	220	2,8	30	24	LP2202830F24	32,30	36	LP2202830F36	40,40	48	LP2202830F48	47,20
2118, 2120, 2171, 2293, 2294	230	2,8	30	24	LP2302830F24	35,80	36	LP2302830F36	43,90	48	LP2302830F48	52,00
HKD65, 2268	240	2,8	30	24	LP2402830F24	37,00	36	LP2402830F36	43,90	48	LP2402830F48	51,60

# LAMA CIRCOLARE PER MACCHINE PORTATILI

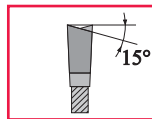
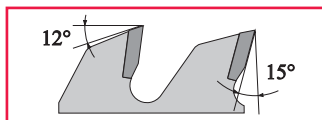
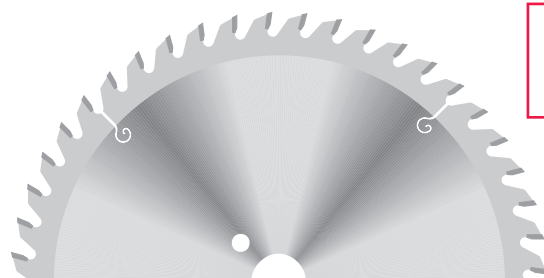

**GB** Circular saw blade for portable machines

**F** Scies circulaires pour machines portables

**E** Hoja de sierra para maquinas portatiles

<b>KITY</b>	D	B	d	Z	COD	€	Z	COD	€	Z	COD	€
O618	200	2,8	30	24	LP2002830F24	29,10	36	LP2002830F36	36,40	48	LP2002830F48	43,10
<b>KRESS</b>	D	B	d	Z	COD	€	Z	COD	€	Z	COD	€
CHKS 6055/6050	160	2,6	20	12	LP1602620F12	21,10	24	LP1602620F24	27,70	40	LP1602620F40	26,40
CHKS 6060/1600	190	2,6	20	12	LP1902620F12	22,50	24	LP1902620F24	29,60	40	LP1902620F40	37,70
<b>MAFELL</b>	D	B	d	Z	COD	€	Z	COD	€	Z	COD	€
SF32,X40,XE40	125	2,4	20				20	LP125242020	26,90			
MKS65, MS55, PS52, B55, FU50, X55, XE55, A55	160	2,6	20	12	LP1602620F12	21,10	24	LP1602620F24	27,70	40	LP1602620F40	26,40
KS320	160	2,6	30				24	LP1602630F24	27,70	40	LP1602630F40	36,40
MKS65, MS65	190	2,6	30	12	LP1902630F12	22,50	24	LP1902630F24	29,60	40	LP1902630F40	37,70
B65, X72	200	2,8	30	24	LP2002830F24	26,10	36	LP2002830F36	36,40	48	LP2002830F48	43,10
HKS75, MS75	210	2,8	30	24	LP2102830F24	31,00	36	LP2102830F36	39,20	48	LP2102830F48	46,80
B82	240	2,8	30	24	LP2402830F24	37,00	36	LP2402830F36	43,90	48	LP2402830F48	51,60
MKS85, MS85, ERIKA85	250	3,2	30				40	LU2503230F40	35,80	60	LU2503230F60	42,90
<b>MAKITA</b>	D	B	d	Z	COD	€	Z	COD	€	Z	COD	€
5600B	150	2,4	20	12	LP150242012	20,80	24	LP150242024	27,70	40	LP150242040	36,40
5600NB, 5600RDW	160	2,6	20	12	LP1602620F12	21,10	24	LP1602620F24	27,70	40	LP1602620F40	36,40
5800B, 5801B	180	2,6	20				24	LP1802620F24	29,60	40	LP1802620F40	37,70
5800BR	190	2,6	20	12	LP1902620F12	22,50	24	LP1902620F24	29,60	40	LP1902620F40	37,70
5703R	190	2,6	30	12	LP1902630F12	22,50	24	LP1902630F24	29,60	40	LP1902630F40	37,70
SR2100, LS0810	210	2,8	25	24	LP210282524	31,00	36	LP210282536	39,20	48	LP210282548	46,80
SR2300, 5900B-R	235	2,8	25	24	LP235282524	37,00	36	LP235282536	43,90	48	LP235282548	51,60
5903R	235	2,8	30	24	LP2352830F24	37,00	36	LP2352830F36	43,90	48	LP2352830F48	51,60
<b>METABO</b>	D	B	d	Z	COD	€	Z	COD	€	Z	COD	€
BTK0, KS0846S, KS0852S, 4341S, 61+2, KS52S, KS0946S	150	2,4	20	12	LP150242012	20,80	24	LP150242024	27,70	40	LP150242040	36,40
BTK1, KS1155S	160	2,6	20	12	LP1602620F12	21,10	24	LP1602620F24	27,70	40	LP1602620F40	36,40
6317S	180	2,6	20				24	LP1802620F24	29,60	40	LP1802620F40	37,70
KS4345S, 5348, KS4346S, KS65S, KS1468, KSE1668, KS1266S	190	2,6	20	12	LP1902620F12	22,50	24	LP1902620F24	29,60	40	LP1902620F40	37,70
KSE1678, KGS1670	210	2,8	30	24	LP2102830F24	31,00	36	LP2102830F36	39,20	48	LP2102830F48	46,80
6322-S	220	2,8	30	24	LP2202830F24	32,30	36	LP2202830F36	40,40	48	LP2202830F48	47,20
KS6323, KS1785S	240	2,8	30	24	LP2402830F24	37,00	36	LP2402830F36	43,90	48	LP2402830F48	51,60
TK168S, TK168S, Tk1688, TKU1633, TKU1693	250	3,2	30				40	LU2503230F40	35,80	60	LU2503230F60	42,90
<b>PERLES</b>	D	B	d	Z	COD	€	Z	COD	€	Z	COD	€
KS50	150	2,4	20	12	LP150242012	20,80	24	LP150242024	27,70	40	LP150242040	36,40
KS70	210	2,8	30	24	LP2102830F24	31,00	36	LP2102830F36	39,20	48	LP2102830F48	46,80
<b>RYOBI</b>	D	B	d	Z	COD	€	Z	COD	€	Z	COD	€
MS50	150	2,4	16				24	LP150241624	27,70			
MS45, MS45E	150	2,4	20	12	LP150242012	20,80	24	LP150242024	27,70	40	LP150242040	36,40
FM, W5502C	160	2,6	16	12	LP160261612	22,50	24	LP160261624	26,70	40	LP160261640	36,40
MS55	160	2,6	20	12	LP1602620F12	21,10	24	LP1602620F24	27,70	40	LP1602620F40	36,40
MS65	190	2,6	30	12	LP1902630F12	22,50	24	LP1902630F24	29,60	40	LP1902630F40	37,70
MS70	200	2,8	30	24	LP2002830F24	29,10	36	LP2002830F36	36,40	48	LP2002830F48	43,10
MS85, MS80	220	2,8	30	24	LP2202830F24	32,30	36	LP2202830F36	40,40	48	LP2202830F48	47,20
MS85	230	2,8	30	24	LP2302830F24	35,80	36	LP2302830F36	43,90	48	LP2302830F48	52,00
FM10A, 3100, 4200	240	2,8	30	24	LP2402830F24	37,00	36	LP2402830F36	43,90	48	LP2402830F48	51,60
<b>SKIL</b>	D	B	d	Z	COD	€	Z	COD	€	Z	COD	€
5246S	150	2,4	16				24	LP150241624	27,70			
1850, 1850H	150	2,4	20	12	LP150242012	20,80	24	LP150242024	27,70	40	LP150242040	36,40
416, 534, 536, 552, 77, 537, 553, BIH	160	2,6	16	12	LP160261612	22,50	24	LP160261624	27,70	40	LP160261640	36,40
559, 574, 857, 1865	184	2,6	16				24	LP184261624	29,60	40	LP184261640	37,70
1865, 5266, 5366, 5466	190	2,6	16	12	LP1902616F12	22,50	24	LP1902616F24	29,60	40	LP1902616F40	37,70
1965, 5566, 5666	190	2,6	30	12	LP1902630F12	22,50	24	LP1902630F24	29,60	40	LP1902630F40	37,70
1524H, 1873H, 1525, 1886, 1985	210	2,8	25	24	LP210282524	31,00	36	LP210282536	39,20	48	LP210282548	46,80
1986	235	2,8	30	24	LP2352830F24	37,00	36	LP2352830F36	43,90	48	LP2352830F48	51,60
<b>STAYER</b>	D	B	d	Z	COD	€	Z	COD	€	Z	COD	€
PROFILINE, CP46	140	2,4	20				20	LP140242020	26,90			
CP50	150	2,4	20	12	LP150242012	20,80	24	LP150242024	27,70	40	LP150242040	36,40
SLL250, SCE250, CP66	250	3,2	30				40	LU2503230F40	35,80	60	LU2503230F60	42,90

# LAMA CIRCOLARE PER MACCHINE PORTATILI

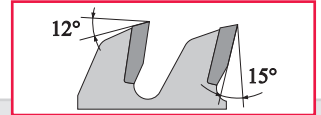
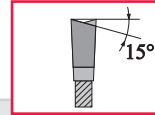

**GB** Circular saw blade for portable machines

**F** Scies circulaires pour machines portables

**E** Hoja de sierra para maquinas portatiles

I  
M

1  
8  
6

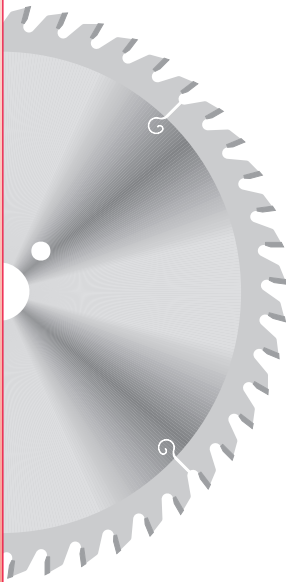

	D	B	b	d	●●●	Z	COD	€
△	125	2,4	1,4	20		20	LP125242020	26,90
○	130	2,4	1,4	20		20	LP130242020	26,90
○	140	2,4	1,4	20		20	LP140242020	26,90
□	150	2,4	1,4	16		24	LP150241624	27,70
□	150	2,4	1,4	20		12	LP150242012	20,80
○	150	2,4	1,4	20		24	LP150242024	27,70
△	150	2,4	1,4	20		40	LP150242040	36,40
○	160	2,4	1,6	20	2/7/32	48	LP1602420F48	43,80
□	160	2,6	1,6	16		12	LP160261612	21,10
□	160	2,6	1,6	16		24	LP160261624	27,70
□	160	2,6	1,6	16		40	LP160261640	36,40
○	160	2,6	1,6	20	2/6/32	12	LP1602620F12	21,10
○	160	2,6	1,6	20	2/6/32	24	LP1602620F24	27,70
○	160	2,6	1,6	20	2/6/32	40	LP1602620F40	36,40
△	160	2,6	1,6	30	2/7/42	24	LP1602630F24	27,70
○	160	2,6	1,6	30	2/7/42	40	LP1602630F40	36,40
△	170	2,6	1,6	30	2/7/42	24	LP1702630F24	29,60
△	170	2,6	1,6	30	2/7/42	40	LP1702630F40	37,70
○	180	2,6	1,6	20	2/6/32	24	LP1802620F24	29,60
○	180	2,6	1,6	20	2/6/32	40	LP1802620F40	37,70
□	180	2,6	1,6	30	2/7/42	12	LP1802630F12	21,90
△	180	2,6	1,6	30	2/7/42	24	LP1802630F24	29,60
○	180	2,6	1,6	30	2/7/42	40	LP1802630F40	37,70
□	184	2,6	1,6	16		24	LP184261624	29,60
□	184	2,6	1,6	16		40	LP184261640	37,70
□	184	2,6	1,6	30		24	LP184263024	29,60
□	184	2,6	1,6	30		40	LP184263040	37,70
□	190	2,6	1,6	16	2/6/32	12	LP1902616F12	22,50
□	190	2,6	1,6	16	2/6/32	24	LP1902616F24	29,60
□	190	2,6	1,6	16	2/6/32	40	LP1902616F40	37,70
△	190	2,6	1,6	20	2/6/32	12	LP1902620F12	22,50
○	190	2,6	1,6	20	2/6/32	24	LP1902620F24	29,60
○	190	2,6	1,6	20	2/6/32	40	LP1902620F40	37,70
△	190	2,6	1,6	30	2/7/42	12	LP1902630F12	22,50
○	190	2,6	1,6	30	2/7/42	24	LP1902630F24	29,60
○	190	2,6	1,6	30	2/7/42	40	LP1902630F40	37,70
△	200	2,8	1,8	30	2/7/42	24	LP2002830F24	29,10
○	200	2,8	1,8	30	2/7/42	36	LP2002830F36	36,40
○	200	2,8	1,8	30	2/7/42	48	LP2002830F48	43,10
□	210	2,8	1,8	25		24	LP210282524	31,00
□	210	2,8	1,8	25		36	LP210282536	39,20
□	210	2,8	1,8	25		48	LP210282548	46,80
○	210	2,8	1,8	30	2/7/42	24	LP2102830F24	31,00
○	210	2,8	1,8	30	2/7/42	36	LP2102830F36	39,20
○	210	2,8	1,8	30	2/7/42	48	LP2102830F48	46,80
△	216	2,8	1,8	30		24 NEG	LP216283024	34,50
△	216	2,8	1,8	30		48 NEG	LP216283048	49,90
△	216	2,8	1,8	30		64 NEG	LP216283064	59,30
△	220	2,8	1,8	30	2/7/42	24	LP2202830F24	32,30
○	220	2,8	1,8	30	2/7/42	36	LP2202830F36	40,40
△	220	2,8	1,8	30	2/7/42	48	LP2202830F48	47,20
○	230	2,8	1,8	30	2/7/42	24	LP2302830F24	36,80
○	230	2,8	1,8	30	2/7/42	36	LP2302830F36	43,90
○	230	2,8	1,8	30	2/7/42	48	LP2302830F48	52,00
□	235	2,8	1,8	25		24	LP235282524	37,00
□	235	2,8	1,8	25		36	LP235282536	43,90
□	235	2,8	1,8	25		48	LP235282548	51,60
○	235	2,8	1,8	30	2/7/42	24	LP2352830F24	37,00
○	235	2,8	1,8	30	2/7/42	36	LP2352830F36	43,90
□	235	2,8	1,8	30	2/7/42	48	LP2352830F48	51,60
□	240	2,8	1,8	30	2/7/42	24	LP2402830F24	37,00
□	240	2,8	1,8	30	2/7/42	36	LP2402830F36	43,90
□	240	2,8	1,8	30	2/7/42	48	LP2402830F48	51,60
○	250	3,2	2,2	30	PH2	40	LU2503230F40	38,00
○	250	3,2	2,2	30	PH2	60	LU2503230F60	42,90
○	305	3,2	2,2	30	PH2	60 NEG	LP3053230F60N	62,40

I  
M

1  
8  
7

# LAME CIRCOLARI PER PORTATILI

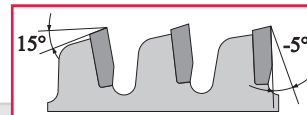
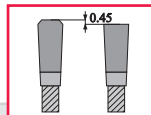

**GB** Portable circular saw blades

**F** Scies pour machines portables

**E** Hojas de sierra para máquinas portátiles

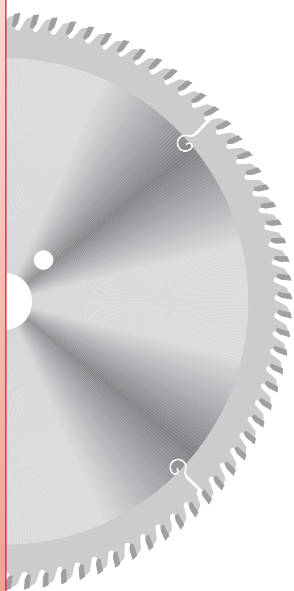

	D	B	b	d	●●●	Z	COD	€
○	160	2,2	1,6	20	2/6/32	56	LP1602220F56TN	51,20
○	160	2,8	1,8	20	2/6/32	42	LP1602820F42TN	41,80
○	180	2,8	1,8	20	2/6/32	48	LP1802820F48TN	43,40
○	190	2,8	1,8	30	2/7/42	54	LP1902830F54TN	51,50
○	210	2,8	1,8	30	2/7/42	54	LP2102830F54TN	51,50
○	216	3,0	2,0	30		64	LP216303064TN	65,80
○	220	3,0	2,0	30	2/7/42	64	LP2203030F64TN	65,80

# SETTORI PER TRUCIOLATORI

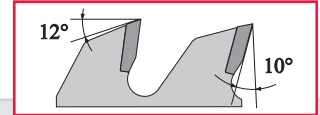
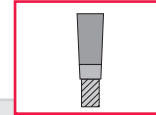

**GB** Trimming hogger segments

**F** Segments pour déchiqueteurs

**E** Segmentos para tridurador

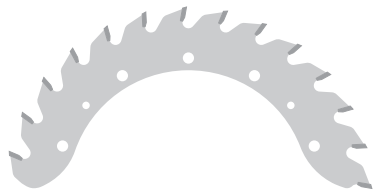

**SWEBO**

	D	B	b	Z	COD DX-RH	COD SX-LH	€
△	200	4,0/5,0	2,5	12	TS2004012D/C	TS2004012S/C	*
△	250	4,0/6,0	2,7	14	TS2504014D/C	TS2504014S/C	*
△	300	4,0/6,0	2,7	14	TS3004014D/C	TS3004014S/C	*



**LEITZ**

□	250	4,5/6,0	2,6	7	TS250457D/F	TS250457S/F	68,40
□	300	4,5/6,0	2,6	9	TS300459D/F	TS300459S/F	77,80
□	350	4,5/6,0	2,6	10	TS3504510D/F	TS3504510S/F	87,80



**LEUCO**

○	200	4,0	2,8	4	TS200404D/E	TS200404S/E	34,60
○	250	4,0	2,8	4	TS250404D/E	TS250404S/E	34,60
□	200	4,0	2,8	5	TS200405D/E	TS200405S/E	48,40
□	250	4,0	2,8	5	TS250405D/E	TS250405S/E	48,40



**LEUCO**

□	250	4,0	2,8	6	TS250406D/E	TS250406S/E	62,30
□	250	4,0	2,8	8	TS250408D/E	TS250408S/E	79,20
□	300	4,0	2,8	6	TS300406D/E	TS300406S/E	62,30
□	300	4,0	2,8	8	TS300408D/E	TS300408S/E	79,20
□	300	4,0	2,8	10	TS3004010D/E	TS3004010S/E	94,40
□	350/430	4,0	2,8	6	TS350406D/E	TS350406S/E	62,30
□	350/430	4,0	2,8	8	TS350408D/E	TS350408S/E	79,20
□	350/430	4,0	2,8	10	TS3504010D/E	TS3504010S/E	94,40



**WITOX**

○	200	5,0	2,8	7	TS200507D/A	TS200507S/A	63,00
○	250	5,0/7,0	2,8	7	TS250507D/A	TS250507S/A	63,00
△	300	5,0/7,0	2,8	7	TS300507D/A	TS300507S/A	63,00
●	200	6,2	2,8	7	TS200627D/A	TS200627S/A	54,60
●	250	6,2	2,8	7	TS250627D/A	TS250627S/A	54,60
●	300	6,2	2,8	7	TS300627D/A	TS300627S/A	54,60
●	350	6,2	2,8	7	TS350627D/A	TS350627S/A	54,60
●	250	6,2	2,8	13	TS2506213D/A	TS2506213S/A	96,00
●	300	6,2	2,8	13	TS3006213D/A	TS3006213S/A	96,00

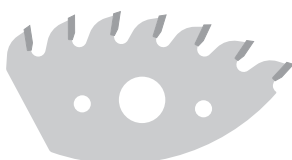

**WITOX**

○	250	5,0	2,8	7	TS250507D/A1	TS250507S/A1	58,20
△	300	5,0	2,8	7	TS300507D/A1	TS300507S/A1	58,20
□	350	5,0	2,8	7	TS350507D/A1	TS350507S/A1	58,20
□	250	5,0	2,8	13	TS2505013D/A1	TS2505013S/A1	96,00
□	300	5,0	2,8	13	TS3005013D/A1	TS3005013S/A1	96,00
△	350	5,0	2,8	12	TS3505013D/A1	TS3505013S/A1	96,00



# LAMA CIRCOLARE PER TRUCIOLATORI

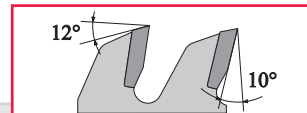
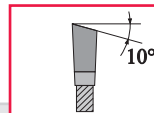
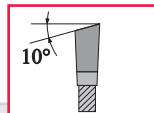

**GB** Circular saw blade for trimming hogsers

**F** Scie circulaire pour déchiquteurs

**E** Hoja de sierra para desmenuzadores

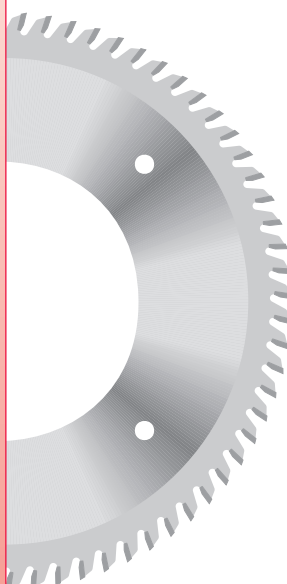

	D	B	b	d	●●●	Z	COD DX-RH	COD SX-LH	€
○	200	4,0	2,8	80	4 LEUCO	44-4	TL2004080F44PD	TL2004080F44PS	74,00
□	200	4,0	2,8	80	4 LEUCO	48	TL2004080F48D/E	TL2004080F48S/E	78,50
□	200	4,0	2,8	80	4 LEUCO	64-4	TL2004080F64PD/E	TL2004080F64PS/E	81,20
□	205	4,1	2,8	80		48	TL205418048D	TL205418048S	68,30
□	205	4,1	2,8	80		60	TL205418060D	TL205418060S	72,60
○	205	4,1	2,8	80	3 WITOX	48-3	TL2054180F48D/A	TL2054180F48S/A	78,50
○	205	4,1	2,8	80		60-3	TL2054180F60PD/A	TL2054180F60PS/A	81,20
○	220	4,0	2,8	80	6 LEUCO	60	TL2204080F60D	TL2204080F60S	78,50
□	250	4,1	2,8	80		60	TL250418060D	TL250418060S	84,00
□	250	4,1	2,8	130		60	TL2504113060D	TL2504113060S	84,00
△	250	4,0	2,8	80	6 LEUCO	54-6	TL2504080F54PD	TL2504080F54PS	80,60
△	250	4,0	2,8	100	6 LEUCO	78-6	TL25040100F78PD	TL25040100F78PS	95,90
□	255	4,1	2,8	130		40	TL2554113040D	TL2554113040S	73,90
□	255	4,1	2,8	80		60	TL255418060D	TL255418060S	75,30
□	255	4,1	2,8	130		60	TL2554113060D	TL2554113060S	75,30
□	255	4,1	2,8	130	4 WITOX	40	TL25541130F40D/A	TL25541130F40S/A	73,90
□	255	4,1	2,8	130	4 WITOX	60	TL25541130F60D/A	TL25541130F60S/A	75,30
□	255	4,1	2,8	130		80	TL2554113080D	TL2554113080S	94,90
○	255	4,1	2,8	130	4 WITOX	60-4	TL25541130F60PD/A	TL25541130F60PS/A	75,30
□	255	4,1	2,8	130	4 WITOX	80-4	TL25541130F80PD/A	TL25541130F80PS/A	94,90
○	255	4,1	2,8	100	6 LEUCO	60-6	TL25541100F60PD/E	TL25541100F60PS/E	80,60
○	255	4,1	2,8	100	6 LEUCO	78-6	TL25541100F78PD/E	TL25541100F78PS/E	95,50
○	255	4,1	2,8	130	6 SWEBO	60-2	TL25541130F60PD/C	TL25541130F60PS/C	80,60
□	255	4,1	2,8	130	6 SWEBO	80-2	TL25541130F80PD/C	TL25541130F80PS/C	95,50
□	255	4,1	2,8	130	10 FREUD	60-4	TL25541130F60PD/B	TL25541130F60PS/B	84,70
□	305	4,1	2,8	155		72	TL3054115572D	TL3054115572S	118,60
□	305	4,1	2,8	155	6 WITOX	48	TL30541155F48D/A	TL30541155F48S/A	89,90
○	305	4,1	2,8	155	6 WITOX	72-6	TL30541155F72PD/A	TL30541155F72PS/A	98,50
□	305	4,1	2,8	155	6 WITOX	96-6	TL30541155F96PD/A	TL30541155F96PS/A	112,20
□	350	4,1	2,8	155	8 WITOX	56	TL35041155F56D/A	TL35041155F56S/A	122,50
□	350	4,1	2,8	155	8 WITOX	80	TL35041155F80D/A	TL35041155F80S/A	132,00

# MODIFICHE LAME STANDARD

**GB** Modifications for standard saw blades

**F** Modifications de scies standard

**E** Modificas hojas standard

**SUPPLEMENTO PER RIVESTIMENTO "GDA COATED"**  
**ADDITIONAL COST FOR "GDA COATED"**  
**SUPPLEMENT DE PRIX POUR LE REVÊTEMENT "GDA COATED"**  
**SUPLEMENTO PARA REVESTIMIENTO**

D	€
80 ÷ 200	5,50
201 ÷ 300	6,80
301 ÷ 400	11,00
401 ÷ 500	20,80
501 ÷ 550	23,50
551 ÷ 600	27,30
601 ÷ 650	35,00
651 ÷ 700	46,80

QUANTITATIVO MINIMO ORDINABILE 20 PEZZI PER TIPO  
 MINIMUM QUANTITY FOR EACH ORDER 20 PCS  
 QUANTITÉ MINIMALE POUR CHAQUE COMMANDE : 20 PIÈCES  
 CANTIDAD MINIMA ORDENABLE 20 PIEZAS POR TIPO

**SUPPLEMENTO PER SILENZIATURA LAME**  
**ADDITIONAL COST FOR LOW NOISE SYSTEM**  
**SUPPLEMENT DE PRIX POUR LAMES SILENCIEUSES**  
**SUPLEMENTO PARA SILENCIATURA HOJAS**

D	€
< 250	11,00
251 ÷ 300	13,00
301 ÷ 350	16,00
351 ÷ 400	21,00
401 ÷ 450	25,00
451 ÷ 500	30,00
501 ÷ 600	35,00
601 ÷ 700	42,00

QUANTITATIVO MINIMO ORDINABILE 20 PEZZI PER TIPO  
 MINIMUM QUANTITY FOR EACH ORDER 20 PCS  
 QUANTITÉ MINIMALE POUR CHAQUE COMMANDE : 20 PIÈCES  
 CANTIDAD MINIMA ORDENABLE 20 PIEZAS POR TIPO

**SUPPLEMENTO PER FORI DI TRASCINAMENTO**  
**ADDITIONAL COST FOR PIN HOLES**  
**SUPPLEMENT DE PRIX POUR TROUS D'ENTRÂINEMENT**  
**SUPLEMENTO PARA ORIFICIOS DE ARRASTRE**

**FORI** €

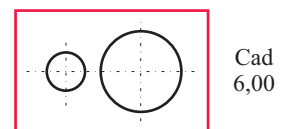

**SUPPLEMENTO PER FORI SVASATI A DISEGNO**  
**ADDITIONAL COST FOR PIN HOLES WITH COUNTERSINK**  
**SUPPLEMENT DE PRIX POUR TROUS FRAISÉS**  
**SUPLEMENTO PARA ORIFICIOS INCLINADOS A MEDIDA**

**FORI** €

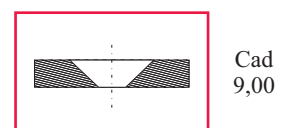

**SUPPLEMENTO PER FORI NON STANDARD**  
**ADDITIONAL COST FOR SPECIAL HOLES**  
**SUPPLEMENT DE PRIX POUR TROUS SPECIAUX**  
**SUPLEMENTO PARA ORIFICIOS NO STANDARD**

d	€
max 50	20,00
51 ÷ 100	30,00

# LAME CIRCOLARI SPECIALI

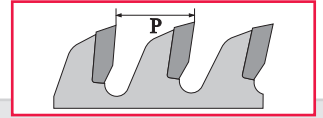

**GB** Special circular saw blades

**F** Scies circulaires spéciaux

**E** Hojas de sierra circular especiales

I prezzi sono indicativi e possibili di modifica in base alle specifiche della lama circolare  
 Prices are indicative and possible amendment in accordance with the specifications of the circular sawblade  
 Les prix sont indicatifs et ils peuvent être modifiés selon les caractéristiques de la scie circulaire  
 Los precios son indicativos y posible modificación de conformidad con las especificaciones de la hoja de sierra

D	B	P	n° pcs 1	n° pcs 2	n° pcs 3-5	n° pcs 6-8	n° pcs 9-12
80 ÷ 200	2,0 ÷ 3,9	> 31,41	242,00	152,00	117,00	82,00	72,00
		31,40 ÷ 13,08	254,00	164,00	129,00	94,00	84,00
		13,07 ÷ 9,81	267,00	177,00	142,00	107,00	97,00

D	B	P	n° pcs 1	n° pcs 2	n° pcs 3-5	n° pcs 6-8	n° pcs 9-12
80 ÷ 200	4,0 ÷ 6,0	> 31,41	252,00	162,00	127,00	92,00	82,00
		31,40 ÷ 13,08	264,00	174,00	139,00	104,00	94,00
		13,07 ÷ 9,81	277,00	187,00	152,00	117,00	107,00

D	B	P	n° pcs 1	n° pcs 2	n° pcs 3-5	n° pcs 6-8	n° pcs 9-12
201 ÷ 300	2,0 ÷ 3,9	> 39,26	260,00	170,00	135,00	100,00	90,00
		39,25 ÷ 19,63	270,00	180,00	145,00	110,00	100,00
		19,62 ÷ 13,08	280,00	190,00	155,00	120,00	110,00
		13,07 ÷ 9,81	290,00	200,00	165,00	130,00	120,00

D	B	P	n° pcs 1	n° pcs 2	n° pcs 3-5	n° pcs 6-8	n° pcs 9-12
201 ÷ 300	4,0 ÷ 6,0	> 39,26	275,00	185,00	150,00	115,00	105,00
		39,25 ÷ 19,63	285,00	195,00	160,00	125,00	115,00
		19,62 ÷ 13,08	295,00	205,00	170,00	135,00	125,00
		13,07 ÷ 9,81	305,00	215,00	180,00	145,00	135,00

D	B	P	n° pcs 1	n° pcs 2	n° pcs 3-5	n° pcs 6-8	n° pcs 9-12
301 ÷ 350	2,5 ÷ 4,5	> 39,26	280,00	185,00	150,00	115,00	105,00
		39,25 ÷ 19,63	290,00	195,00	160,00	125,00	115,00
		19,62 ÷ 13,08	300,00	205,00	170,00	135,00	125,00
		13,07 ÷ 9,81	310,00	215,00	180,00	145,00	135,00

D	B	P	n° pcs 1	n° pcs 2	n° pcs 3-5	n° pcs 6-8	n° pcs 9-12
301 ÷ 350	4,6 ÷ 6,2	> 39,26	295,00	205,00	170,00	135,00	125,00
		39,25 ÷ 19,63	305,00	215,00	180,00	145,00	135,00
		19,62 ÷ 13,08	315,00	225,00	190,00	155,00	145,00
		13,07 ÷ 9,81	325,00	235,00	200,00	165,00	155,00

D	B	P	n° pcs 1	n° pcs 2	n° pcs 3-5	n° pcs 6-8	n° pcs 9-12
351 ÷ 400	3,0 ÷ 4,5	> 39,26	300,00	210,00	175,00	140,00	130,00
		39,25 ÷ 19,63	310,00	220,00	185,00	150,00	140,00
		19,62 ÷ 13,08	320,00	230,00	195,00	160,00	150,00
		13,07 ÷ 9,81	330,00	240,00	205,00	170,00	160,00

D	B	P	n° pcs 1	n° pcs 2	n° pcs 3-5	n° pcs 6-8	n° pcs 9-12
351 ÷ 400	4,7 ÷ 6,2	> 39,26	315,00	225,00	190,00	155,00	145,00
		39,25 ÷ 19,63	325,00	235,00	200,00	165,00	155,00
		19,62 ÷ 13,08	335,00	245,00	210,00	175,00	165,00
		13,07 ÷ 9,81	345,00	255,00	220,00	185,00	175,00

D	B	P	n° pcs 1	n° pcs 2	n° pcs 3-4	n° pcs 5-7	n° pcs 8-10
401 ÷ 450	3,2 ÷ 5,0	> 44,17	330,00	240,00	205,00	180,00	165,00
		44,16 ÷ 29,44	340,00	250,00	215,00	190,00	175,00
		29,43 ÷ 19,63	350,00	260,00	225,00	200,00	185,00
		19,62 ÷ 13,08	360,00	270,00	235,00	210,00	195,00
		13,07 ÷ 9,81	370,00	280,00	245,00	220,00	205,00

D	B	P	n° pcs 1	n° pcs 2	n° pcs 3-4	n° pcs 5-7	n° pcs 8-10
401 ÷ 450	5,1 ÷ 6,2	> 44,17	350,00	260,00	225,00	200,00	185,00
		44,16 ÷ 29,44	360,00	270,00	235,00	210,00	195,00
		29,43 ÷ 19,63	370,00	280,00	245,00	220,00	205,00
		19,62 ÷ 13,08	380,00	290,00	255,00	230,00	215,00
		13,07 ÷ 9,81	390,00	300,00	265,00	240,00	225,00

D	B	P	n° pcs 1	n° pcs 2	n° pcs 3-4	n° pcs 5-7	n° pcs 8-10
451 ÷ 500	3,2 ÷ 5,0	> 44,17	370,00	280,00	245,00	220,00	205,00
		44,16 ÷ 29,44	380,00	290,00	255,00	230,00	215,00
		29,43 ÷ 19,63	390,00	300,00	265,00	240,00	225,00
		19,62 ÷ 13,08	400,00	310,00	275,00	250,00	235,00
		13,07 ÷ 9,81	420,00	330,00	295,00	270,00	255,00

D	B	P	n° pcs 1	n° pcs 2	n° pcs 3-4	n° pcs 5-7	n° pcs 8-10
451 ÷ 500	5,1 ÷ 6,2	> 44,17	400,00	310,00	275,00	250,00	235,00
		44,16 ÷ 29,44	410,00	320,00	285,00	260,00	245,00
		29,43 ÷ 19,63	420,00	330,00	295,00	270,00	255,00
		19,62 ÷ 13,08	430,00	340,00	305,00	280,00	265,00
		13,07 ÷ 9,81	550,00	360,00	325,00	300,00	285,00

D	B	P	n° pcs 1	n° pcs 2	n° pcs 3-4	n° pcs 5-7	n° pcs 8-10
501 ÷ 550	4,0 ÷ 6,2	> 48,00	440,00	350,00	315,00	290,00	275,00
		47,99 ÷ 29,44	450,00	360,00	325,00	300,00	285,00
		29,43 ÷ 19,63	460,00	370,00	335,00	310,00	295,00
		19,62 ÷ 13,08	470,00	380,00	345,00	320,00	305,00
		13,07 ÷ 9,81	490,00	400,00	365,00	340,00	325,00

D	B	P	n° pcs 1	n° pcs 2	n° pcs 3-4	n° pcs 5-7	n° pcs 8-10
551 ÷ 600	4,0 ÷ 6,2	> 48,00	480,00	390,00	355,00	330,00	315,00
		47,99 ÷ 29,44	490,00	400,00	365,00	340,00	325,00
		29,43 ÷ 19,63	500,00	410,00	375,00	350,00	335,00
		19,62 ÷ 13,08	510,00	420,00	385,00	360,00	345,00
		13,07 ÷ 9,81	530,00	440,00	405,00	380,00	365,00

# LAME CIRCOLARI SPECIALI

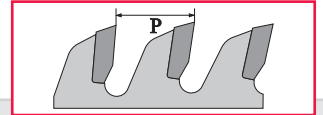

**GB** Special circular saw blades

**F** Scies circulaires speciaux

**E** Hojas de sierra circular especiales

D	B	P	n° pcs 1	n° pcs 2	n° pcs 3	n° pcs 4-5	n° pcs 6-8
		> 51,05	530,00	440,00	405,00	390,00	375,00
601	4,8	51,04 ÷ 31,90	540,00	450,00	415,00	400,00	385,00
		31,89 ÷ 21,27	550,00	460,00	425,00	410,00	395,00
650	6,2	21,26 ÷ 16,32	560,00	470,00	435,00	420,00	405,00
		16,31 ÷ 13,08	590,00	500,00	465,00	450,00	435,00
		13,07 ÷ 10,40	620,00	530,00	495,00	480,00	465,00

D	B	P	n° pcs 1	n° pcs 2	n° pcs 3	n° pcs 4-5	n° pcs 6-8
		> 51,05	560,00	470,00	435,00	420,00	405,00
651	4,8	51,04 ÷ 31,90	570,00	480,00	445,00	430,00	415,00
		31,89 ÷ 21,27	580,00	490,00	455,00	440,00	425,00
700	6,2	21,26 ÷ 16,32	590,00	500,00	465,00	450,00	435,00
		16,31 ÷ 13,08	620,00	530,00	495,00	480,00	465,00
		13,07 ÷ 10,40	650,00	560,00	525,00	510,00	495,00

**DETERMINAZIONE PASSO P**  
**HOW TO DETERMINE P**  
**DETERMINATION DE P**  
**DETERMINACION PASO P**

$$P = \frac{p \times D}{Z}$$

**ESEMPIO**  
**EXAMPLE**  
**EXEMPLE**  
**EJEMPLO**

5 pcs 290x5,3/3,2x40 Z=64

$$P = \frac{3,14 \times 290}{64} = 14,23 \quad \epsilon = 170,00$$

**SUPPLEMENTO RIVESTIMENTO "GDA COATED"**  
**ADDITIONAL COST FOR "GDA COATED"**  
**SUPPLEMENT DE PRIX POUR "GDA COATED"**  
**SUPLEMENTO REVESTIMIENTO "GDA COATED"**

**+7%**

**SUPPLEMENTO SILENZIATURA**  
**ADDITIONAL COST FOR LOW NOISE SYSTEM**  
**SUPPLEMENT DE PRIX POUR LAMES SILENCIEUSES**  
**SUPLEMENTO SILENCIADORA**

**+8%**

**SUPPLEMENTO RASANTI HM**  
**ADDITIONAL COST FOR STROBES HM**  
**SUPPLEMENT DE PRIX POUR RACLEURS**  
**SUPLEMENTO RASURACIONES**

**+20%**

# LAME CIRCOLARI SPECIALI A GRANDE DIAMETRO

**GB** Special circular saw blades

**F** Scies circulaires speciaux

**E** Hojas de sierra circular especiales

I prezzi sono indicativi e possibili di modifica in base alle specifiche della lama circolare  
Prices are indicative and possible amendment in accordance with the specifications of the circular sawblade  
Les prix sont indicatifs et ils peuvent être modifiés selon les caractéristiques de la scie circulaire  
Los precios son indicativos y posible modificación de conformidad con las especificaciones de la hoja de sierra

D	B	Z	b	n° pcs 1	n° pcs 2	n° pcs 3-4	n° pcs 5-8
701	5,5	28 - 48	4,4	900,00	700,00	635,00	600,00
		49 - 72		960,00	760,00	695,00	660,00
		73 - 96		1020,00	820,00	755,00	720,00
770	6,0	97 - 120	5,0	1080,00	880,00	815,00	780,00
		28 - 48		1000,00	800,00	735,00	700,00
701	6,2	49 - 72	5,0	1060,00	860,00	795,00	760,00
		73 - 96		1120,00	920,00	855,00	820,00
770	7,5	97 - 120	5,0	1180,00	980,00	915,00	880,00

D	B	Z	b	n° pcs 1	n° pcs 2	n° pcs 3-4	n° pcs 5-8
771	5,5	28 - 48	4,4	930,00	730,00	665,00	630,00
		49 - 72		990,00	790,00	725,00	690,00
		73 - 96		1050,00	850,00	785,00	750,00
800	6,0	97 - 120	5,0	1110,00	910,00	845,00	810,00
		28 - 48		1030,00	830,00	765,00	730,00
771	6,2	49 - 72	5,0	1090,00	890,00	825,00	790,00
		73 - 96		1150,00	950,00	885,00	850,00
800	7,5	97 - 120	5,0	1210,00	1010,00	945,00	910,00

**SUPPLEMENTO SILENZIATURA**  
**ADDITIONAL COST FOR LOW NOISE SYSTEM**  
**SUPPLEMENT DE PRIX POUR LAMES SILENCIEUSES**  
**SUPLEMENTO SILENCIADORA**

**+10%**

**SUPPLEMENTO RASANTI HM**  
**ADDITIONAL COST FOR STROBES HM**  
**SUPPLEMENT DE PRIX POUR RACLEURS**  
**SUPLEMENTO RASURACIONES**

**+25%**

## ANELLI DI RIDUZIONE FORO PER LAME CIRCOLARI

**(GB)** Reduction rings for circular saw blades

**(F)** Bagues de réduction pour scie circulaire

**(E)** Anillos de reducción para hojas circulares

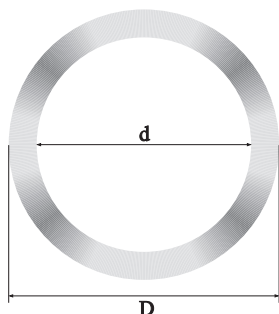

	D	b	d	COD	€
○	20	2,0	12	ARID2012	3,00
○	20	2,0	16	ARID2016	3,00
○	25	2,0	16	ARID2516	3,00
○	25	2,0	20	ARID2520	3,00
○	30	2,0	16	ARID3016	3,00
○	30	2,0	20	ARID3020	2,00
○	30	2,0	25	ARID3025	2,00
○	30	2,0	25,4	ARID30254	2,00
○	32	2,0	20	ARID3220	3,00
○	32	2,0	30	ARID3230	2,00
○	35	2,0	20	ARID3520	3,00
○	35	2,0	25	ARID3525	3,00
○	35	2,0	25,4	ARID35254	3,00
○	35	2,0	30	ARID3530	2,00
○	35	2,0	32	ARID3532	3,00
○	40	2,0	30	ARID4030	4,00
○	40	2,0	32	ARID4032	4,00
○	40	2,0	35	ARID4035	4,00

## ANELLI DISTANZIALI

**(GB)** Spacing rings

**(F)** Bagues de distance

**(E)** Anillos distanciadores

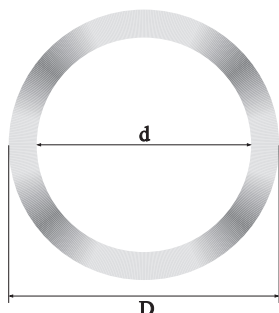
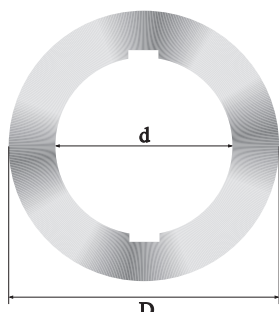

	D	b	d/●	€	d/○	€
A		0,1		12,00		12,00
A		0,2		10,00		10,00
A		0,5 / 1,0	A RICHIESTA	8,00	A RICHIESTA	8,00
A		2,0 / 2,5	SENZA KW	10,00	CON KW	10,00
A		3,0 / 3,5		12,00		12,00
A		4,0	UPON REQUEST	15,00	UPON REQUEST	15,00
B		5,0	WITHOUT KW	20,00	WITH KW	20,00
B	D < 150	6,0		25,00		25,00
B		7,0 / 8,0	SUR DEMANDE	32,00	SUR DEMANDE	39,50
B		9,0 / 10,0	SANS KW	39,50	AVEC KW	48,50
B		11,0 / 15,0		45,00		58,00
B		16,0 / 20,0	SU PREGUNTA	50,50	SU PREGUNTA	67,50
C		21,0 / 30,0	SIN KW	56,50	CON KW	78,50
C		31,0 / 40,0		62,00		86,50
C		41,0 / 50,0		68,00		94,00

QUANTITATIVO MINIMO ORDINABILE PER SPESSORE: A=12 PEZZI - B=6 PEZZI C=3 PEZZI  
 MINIMUM ORDER FOR THICKNESS: A=12 PIECES - B=6 PIECES - C=3 PIECES  
 QUANTITÉ MINIMALE ORDONNABLE POUR ÉPAISSEUR: A=12 PIÈCES - B=6 PIÈCES - C=3 PIÈCES  
 CANTIDAD MINIMÁ ORDENABLE POR ESPESOR: A= 12 PIEZAS - B=6 PIEZAS - C=3 PIEZAS

### Truciolatori a bassa rumorosità in HM e PCD

HW or PCD low noise trimming hoggers

Décheteteurs silencieux en HW et PCD

Desmenzadores a baja rumurodidad de HW y PCD

#### IM 702



86

#### IM 710



88

#### IM 712



88

#### IM 714

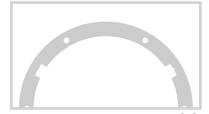

88

#### IM 715



89

#### IM 716



89

### Truciolatori a settori in HM e PCD

HW or PCD trimming hoggers with segments

Décheteteurs avec segments....

Desmenzadores con segmentos....

#### IM 720



90

#### IM 722



93

#### IM 723



93

#### IM 724



93

#### IM 725



93

#### IM 726



94

#### IM 727



94

### Truciolatore a lame in HM o PCD

Trimming hogger with HW or diamond PCD saw blades

Décheteteurs avec lames en HW o en diamant PCD

Desmenzadores con hojas de HW o de diamante PCD

#### IM 734

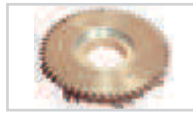

95

#### IM 736



96

#### IM 737



96

#### IM 738

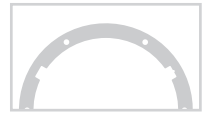

96

### Truciolatore compatto in PCD

PCD diamond trimming hogger

Décheteteur en diamant PCD

Tritrador en diamante PCD

#### IM 740

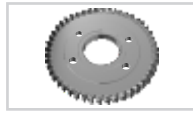

97

#### IM 742



98

### Attacco rapido per truciolatori

Quick pneumatic junctures for trimming hoggers

Jonctions rapides pneumatiques pour décheteteurs

Junturas rápidas neumaticás por desmenzadores

#### PU 401



99

# TRUCIOLATORI UNIVERSALI A BASSA RUMOROSITA'

**GB** Universal low noise trimming hoggers

**F** Déchiqueteurs universel silencieux

**E** Desmenuzadores universales a baja rumurodidad



D 200 x 30



D 250 / 300 / 350 x 30



D 330 x 90

## INFORMAZIONI TECNICHE

Trattasi di gruppi truciolatori a "BASSA RUMOROSITA'" con lame HM o PCD. Corpo in lega leggera con lame per truciolare posizionate a taglio elicoidale, anelli fono-assorbenti e lama principale.

**E' possibile la costruzione di truciolatori con diametro e spessori speciali (D-B-d) per qualsiasi particolare esigenza di lavorazione.**

## TECHNICAL INFORMATION

Group of "LOW NOISE" trimming hoggers, with circular saw blades HM or PCD. Light metal body with circular saw blades to chips, assembled with spiral multicut, low noise rings and main circular saw blades.

**It is possible manufacturing trimming hoggers with diametre and thickness (D-B-d) for every type of work requested.**

## INFORMATIONS TECHNIQUES

Il s'agit d'un groupage de déchiqueteurs silencieux avec lames HM ou PCD. Le corps est en alliage léger avec les lames pour réduire en copeaux positionnées pour une coupe hélicoïdale, les bagues qui absorbaient le bruit et la lame principale. C'est possible la construction de déchiqueteurs avec diamètre et épaisseur spéciaux (D-B-d) pour chaque exigence de travail.

## INFORMACIONES TECNICAS

Tratandose de grupos desmenuzadores a "BAJA RUMUROSIDAD" con hojas HM o PCD. Cuerpo en liga ligera con hojas para desmenuzadores posicionados a corte helicoidal, anillos fono-absorbentes y hoja principale.

**Es posible la construccion de desmenuzadores con diametro y espesores especiales (D-B-d) para cualquier tipo de trabajo**

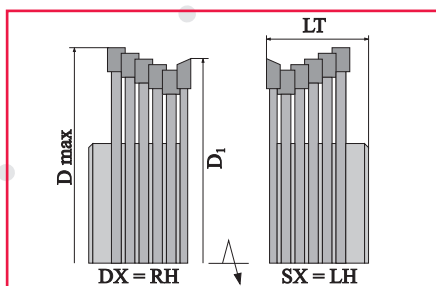

D	D max	D <sub>1</sub>	n max mir
200	208	205	7000
250	258	255	6800
300	308	305	5800
350	358	355	4800

**ALU**

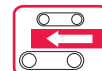

**MEC**

## POSSIBILITA' DI LAVORAZIONE

Assembling possibilities / Possibilité de montage / Posibilidad de trabajo

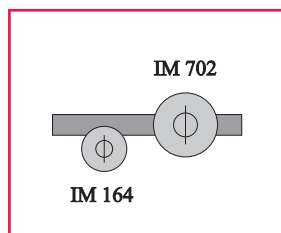

TRUCIOLATORE - INCISORE  
TRIMMING HOGGER SCORING SAW BLADE  
DECHIQUETEUR - INCISEUR  
DESMENUZADOR - INCISOR

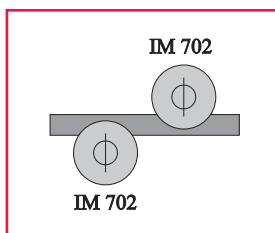

TRUCIOLATORE - TRUCIOLATORE  
TRIMMING HOGGER - TRIMMING HOGGER  
DECHIQUETEUR - DECHIQUETEUR  
DESMENUZADOR - DESMENUZADOR

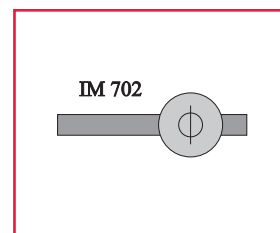

TRUCIOLATORE  
TRIMMING HOGGER  
DECHIQUETEUR  
DESMENUZADOR

UTILIZZO: macchine squadratrici - macchine bordatrici - linee per giunzione di testa - ecc.

USE: squaring & edge banding machines - lines for finger jointing - etc.

USAGE: machines équarrisseuses - à plaquer - lignes pour abourage de tete - etc

UTILIZO: maquinas esquadra - chapeadoras de cantos - linea para empalme tipo peine - exetera

# TRUCIOLATORI UNIVERSALI A BASSA RUMOROSITÀ

GB Universal low noise trimming hogsers   
 F Déchiqueteurs universel silencieux   
 E Desmenuzadores universales a baja rumorosidad

	D	B	d	Z lama princ.	N° lame truc.	LT	COD DX-RH	COD SX-LH	€
△	200	30	35 KW	48	5	92	TC2003035K48D	TC2003035K48S	675,00
△	200	30	40 KW	48	5	92	TC2003040K48D	TC2003040K48S	675,00
△	200	30	35 KW	60-6	5	92	TC2003035K60D	TC2003035K60S	685,00
△	200	30	40 KW	60-6	5	92	TC2003040K60D	TC2003040K60S	685,00
△	200	52	35 KW	48	9	92	TC2005235K48D	TC2005235K48S	935,00
△	200	52	40 KW	48	9	92	TC2005240K48D	TC2005240K48S	935,00
△	200	52	35 KW	60-6	9	92	TC2005235K60D	TC2005235K60S	945,00
△	200	52	40 KW	60-6	9	92	TC2005240K60D	TC2005240K60S	945,00
○	250	30	60	40	5	40	TC250306040D	TC250306040S	605,00
○	250	30	80	40	5	40	TC250308040D	TC250308040S	605,00
○	250	30	60	56	5	40	TC250306056D	TC250306056S	620,00
○	250	30	80	56	5	40	TC250308056D	TC250308056S	620,00
○	250	30	60	80-8	5	40	TC250306080D	TC250306080S	640,00
○	250	30	80	80-8	5	40	TC250308080D	TC250308080S	640,00
○	250	52	60	40	9	62	TC250526040D	TC250526040S	955,00
○	250	52	80	40	9	62	TC250528040D	TC250528040S	955,00
○	250	52	60	56	9	62	TC250526056D	TC250526056S	965,00
○	250	52	80	56	9	62	TC250528056D	TC250528056S	965,00
○	250	52	60	80-8	9	62	TC250526080D	TC250526080S	990,00
○	250	52	80	80-8	9	62	TC250528080D	TC250528080S	990,00
○	300	30	60	48	5	40	TC300306048D	TC300306048S	800,00
○	300	30	80	48	5	40	TC300308048D	TC300308048S	800,00
○	300	30	60	72	5	40	TC300306072D	TC300306072S	810,00
○	300	30	80	72	5	40	TC300308072D	TC300308072S	810,00
○	300	52	60	48	9	62	TC300526048D	TC300526048S	1200,00
○	300	52	80	48	9	62	TC300528048D	TC300528048S	1200,00
○	300	52	60	72	9	62	TC300526072D	TC300526072S	1215,00
○	300	52	80	72	9	62	TC300528072D	TC300528072S	1215,00
○	350	30	60	60	5	40	TC350306060D	TC350306060S	1015,00
○	350	30	80	60	5	40	TC350308060D	TC350308060S	1015,00
○	350	30	60	80	5	40	TC350306080D	TC350306080S	1030,00
○	350	30	80	80	5	40	TC350308080D	TC350308080S	1030,00
△	350	52	60	60	9	62	TC350526060D	TC350526060S	1510,00
△	350	52	80	60	9	62	TC350528060D	TC350528060S	1510,00
△	350	52	60	80	9	62	TC350526080D	TC350526080S	1530,00
△	350	52	80	80	9	62	TC350528080D	TC350528080S	1530,00



IM

710

712

714

# RICAMBI PER IM 702 IN HM

HW SPARES FOR IM 702 / RECHANGES POUR IM 702 EN HW / REPUESTOS PARA IM 702 DE HW

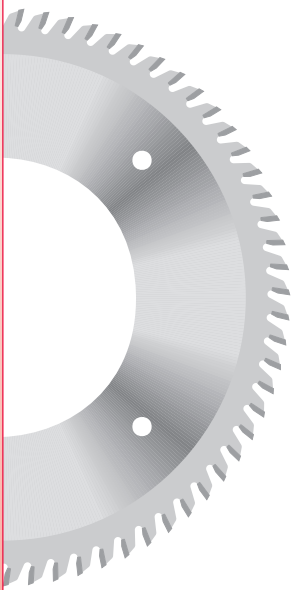

**LAMA PRINCIPALE**  
**MAIN SAW BLADE**  
**SCIE CIRCULAIRE PRINCIPALE**  
**HOJA PRINCIPALE**

	D	B	b	d	fori	Z	COD DX-RH	COD SX-LH	€
○	205	4,1	2,8	80	6	48	TL2054180F48D	TL2054180F48S	68,30
○	205	4,1	2,8	80	6	60-6	TL2054180F60PD	TL2054180F60PS	72,60
○	255	4,1	2,8	130	6	40	TL25541130F40D	TL25541130F40S	73,90
○	255	4,1	2,8	130	6	56	TL25541130F56D	TL25541130F56S	79,40
○	255	4,1	2,8	130	6	80-8	TL25541130F80PD	TL25541130F80PS	95,50
○	305	4,1	2,8	155	9	48	TL30541155F48D	TL30541155F48S	89,90
○	305	4,1	2,8	155	9	72	TL30541155F72D	TL30541155F72S	98,50
○	355	4,1	2,8	180	9	60	TL35541180F60D	TL35541180F60S	122,50
○	355	4,1	2,8	180	9	80	TL35541180F80D	TL35541180F80S	132,00

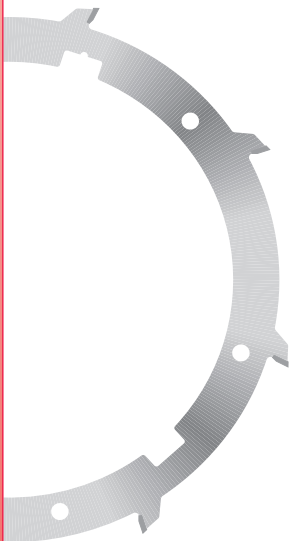

**LAMA TRUCIOLATRICE**  
**CHIPPING CIRCULAR SAW BLADE**  
**SCIE CIRCULAIRE POUR RÉDUIRE EN COUPEAUX**  
**HOJA DESMENUZADORA**

	Truciolatore	Lama	D	Z	COD DX-RH	COD SX-LH	€
○	200	1	200	6	TA2001D	TA2001S	46,00
○		2	202	6	TA2002	TA2002	40,00
○		3	204	6	TA2003	TA2003	40,00
○		4	206	6	TA2004	TA2004	40,00
○		5	208	6	TA2005	TA2005	40,00
○	250	1	250	8	TA2501D	TA2501S	48,00
○		2	252	8	TA2502	TA2502	42,00
○		3	254	8	TA2503	TA2503	42,00
○		4	256	8	TA2504	TA2504	42,00
○		5	258	8	TA2505	TA2505	42,00
○	300	1	300	8	TA3001D	TA3001S	50,00
○		2	302	8	TA3002	TA3002	44,00
○		3	304	8	TA3003	TA3003	44,00
○		4	306	8	TA3004	TA3004	44,00
○		5	308	8	TA3005	TA3005	44,00
○	350	1	350	10	TA3501D	TA3501S	57,00
○		2	352	10	TA3502	TA3502	51,00
○		3	354	10	TA3503	TA3503	51,00
○		4	356	10	TA3504	TA3504	51,00
○		5	358	10	TA3505	TA3505	51,00

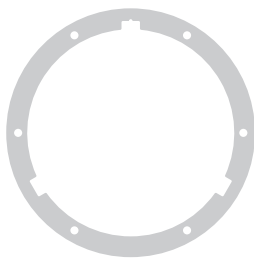

**ANELLO FONNO-ASSORBENTE**  
**LOW NOISE RING / BAGUE POUR RÉDUIRE LE BRUIT / ANILLO FONNO-ABSORBENTE**

	Truciolatore	COD DX-RH	COD SX-LH	€
○	200	TF200	TF200	12,00
○	250	TF250	TF250	14,00
○	300	TF300	TF300	16,00
○	350	TF350	TF350	20,00



FVM855  
€ 3,00



FVM835  
€ 3,00



FVTM512  
€ 3,00



FCM8  
€ 5,00



FCTM5  
€ 5,00

IM



## RICAMBI PER IM 702 IN PCD

PCD SPARES FOR IM 702

RECHANGES POUR IM 702 EN PCD

REPUESTOS PARA IM 702 DE PCD

715

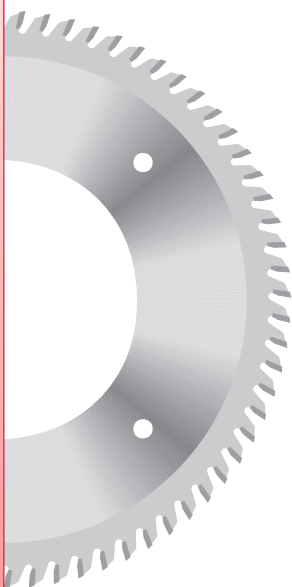

### LAMA PRINCIPALE IN PCD H=6

MAIN PCD SAW BLADE H=6

SCIE CIRCULAIRE PRINCIPALE EN PCD H=6

HOJA PRINCIPALE DE PCD H=6

	D	B	b	d	fori	Z	COD DX-RH	COD SX-LH	€
<input type="checkbox"/>	205	4,2	2,8	80	6	48	TLD2054280F48D	TLD2054280F48D	1171,20
<input type="checkbox"/>	205	4,2	2,8	80	6	60-6	TLD2054280F60PD	TLD2054280F60PD	1317,60
<input type="checkbox"/>	255	4,2	2,8	130	6	40	TLD25542130F40D	TLD25542130F40D	976,00
<input type="checkbox"/>	255	4,2	2,8	130	6	56	TLD25542130F56D	TLD25542130F56D	1366,40
<input type="checkbox"/>	305	4,2	2,8	155	9	48	TLD30542155F48D	TLD30542155F48D	1171,20
<input type="checkbox"/>	305	4,2	2,8	155	9	72	TLD30542155F72D	TLD30542155F72D	1756,80
<input type="checkbox"/>	355	4,2	2,8	180	9	60	TLD35542180F60D	TLD35542180F60D	1464,00
<input type="checkbox"/>	355	4,2	2,8	180	9	80	TLD35542180F80D	TLD35542180F80D	1952,00

716



### LAMA TRUCIOLATRICE IN PCD H=6

PCD CHIPPING CIRCULAR SAW BLADE H=6

SCIE CIRCULAIRE POUR RÉDUIRE EN COUPEAUX EN PCD H=6

HOJA DESMENUZADORA DE PCD H=6

	Trucirolatore	Lama	D	Z	COD DX-RH	COD SX-LH	€
<input type="checkbox"/>	200	1	200	6	TAD2001D	TAD2001S	250,00
<input type="checkbox"/>		2	202	6	TAD2002	TAD2002	250,00
<input type="checkbox"/>		3	204	6	TAD2003	TAD2003	250,00
<input type="checkbox"/>		4	206	6	TAD2004	TAD2004	250,00
<input type="checkbox"/>		5	208	6	TAD2005	TAD2005	250,00
<input type="checkbox"/>	250	1	250	8	TAD2501D	TAD2501S	325,00
<input type="checkbox"/>		2	252	8	TAD2502	TAD2502	325,00
<input type="checkbox"/>		3	254	8	TAD2503	TAD2503	325,00
<input type="checkbox"/>		4	256	8	TAD2504	TAD2504	325,00
<input type="checkbox"/>		5	258	8	TAD2505	TAD2505	325,00
<input type="checkbox"/>	300	1	300	8	TAD3001D	TAD3001S	335,00
<input type="checkbox"/>		2	302	8	TAD3002	TAD3002	335,00
<input type="checkbox"/>		3	304	8	TAD3003	TAD3003	335,00
<input type="checkbox"/>		4	306	8	TAD3004	TAD3004	335,00
<input type="checkbox"/>		5	308	8	TAD3005	TAD3005	335,00
<input type="checkbox"/>	350	1	350	10	TAD3501D	TAD3501S	415,00
<input type="checkbox"/>		2	352	10	TAD3502	TAD3502	415,00
<input type="checkbox"/>		3	354	10	TAD3503	TAD3503	415,00
<input type="checkbox"/>		4	356	10	TAD3504	TAD3504	415,00
<input type="checkbox"/>		5	358	10	TAD3505	TAD3505	415,00

# TRUCIOLATORI A SETTORE

**GB** Trimming hogger with segments

**F** Déchiqueteurs avec segments

**E** Desmenuzadores con segmentos



D 250 / 300 / 350 x 30



D 250 / 300 x 50

## INFORMAZIONI TECNICHE

Truciolatori con lame HM e corpo in lega leggera, settori con Z=7 o Z=13 in HM  
Truciolatori con lame in PCD e corpo in acciaio, settori con Z=7 o Z=13 in HM o PCD

## TECNICAL INFORMATION

Trimming hoggers, with HW saw blades and body in light alloy, segments with Z=7 or Z=13 in HW  
Trimming hoggers, with PCD saw blades and body in steel, segments with Z=7 or Z=13 in HW or in PCD

## INFORMATIONS TECHNIQUES

Déchiqueteurs avec lames en HW et corps en alliage légère, segments avec Z=7 ou Z=13 en HW  
Déchiqueteurs avec lames en PCD et corps en acier, segments avec Z=7 ou Z=13 en HW ou PCD

## INFORMACIONES TECNICAS

Desmenuzadores con hojas de HW y cuerpo de aleación ligero, segmentos con Z=7 o Z=13 de HW  
Desmenuzadores con hojas de PCD y cuerpo de acero, segmentos con Z=7 o Z=13 de HW o PCD

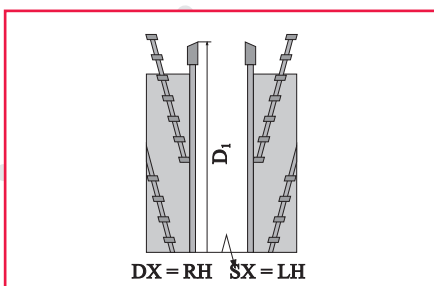

DX = RH SX = LH

D	D max	D <sub>1</sub>	n max min <sup>1</sup>
200	208	205	6000
250	258	255	4000
300	308	305	3000
350	358	355	2800

**ALU**



**MEC**

## POSSIBILITA' DI LAVORAZIONE

Assembling possibilities / Possibilité de montage / Posibilidad de trabajo

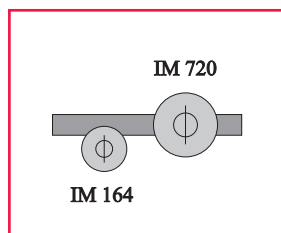

TRUCIOLATORE - INCISORE  
TRIMMING HOGGER SCORING SAW BLADE  
DECHIQUETEUR - INCISEUR  
DESMENUZADOR - INCISOR

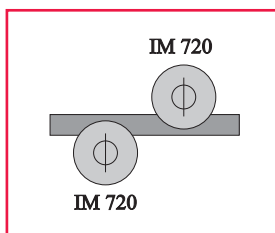

TRUCIOLATORE - TRUCIOLATORE  
TRIMMING HOGGER - TRIMMING HOGGER  
DECHIQUETEUR - DECHIQUETEUR  
DESMENUZADOR - DESMENUZADOR

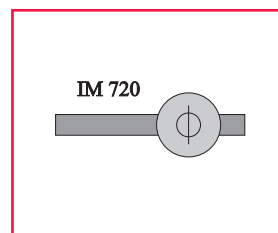

TRUCIOLATORE  
TRIMMING HOGGER  
DECHIQUETEUR  
DESMENUZADOR

UTILIZZO: macchine squadratrici - macchine bordatrici - linee per giunzione di testa - ecc.

USE: squaring & edge banding machines - lines for finger jointing - etc.

USAGE: machines équarri-seuses - à plaquer - lignes pour jonction de tête - etc

UTILIZO: maquinas esquadra - chapeadoras de cantos - linea para empalme tipo peine - exetera

# TRUCIOLATORI A SETTORE

**GB** Trimming hogger with segments

**F** Déchiqueteurs avec segments

**E** Desmenuzadores con segmentos

FORI INDICATIVI DI ALCUNE MACCHINE  
PER TRUCIOLATORI Ø 200 CON MOZZO  
INDICATIVE CENTER BORE FOR SOME  
MACHINES FOR TRIMMING HOGGERS Ø 200

INDICATION DES ALESAGES DE CERTAINES  
MACHINES POUR DÉCHIQUETEURS Ø 200  
ORIFICIOS DE ALGUNAS MAQUINAS PARA  
DESMENUZADORES Ø 200

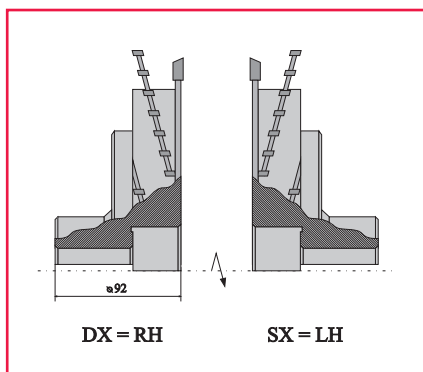

MACCHINA	FORO - CHIAVETTA
CELASCHI	35 - 1 KW 10x4
GABBIANI	40 - 1 KW 10x5
GUBISCH	40 - 2 KW 12x4
HOMAG	35 - 2 KW 10x4
IMA	35 - 2 KW 10x4
SCHWABEDISSEN	40 - 1 KW 12x5
SCHWABEDISSEN	40 - 2 KW 12x5
SPANEVELLO	40 - 1 KW 12x5
TORWEGGE	35 - 2 KW 10x4
TORWEGGE	40 - 2 KW 12x4
WILMSMEYER	35 - 2 KW 10x4

## MOZZO PER TRUCIOLATORI TRIMMING HOGGER MOUNTING FLANGE FLASQUE POUR DÉCHIQUETEURS BRIDA DE SUJECION PARA DESMENUZADORES

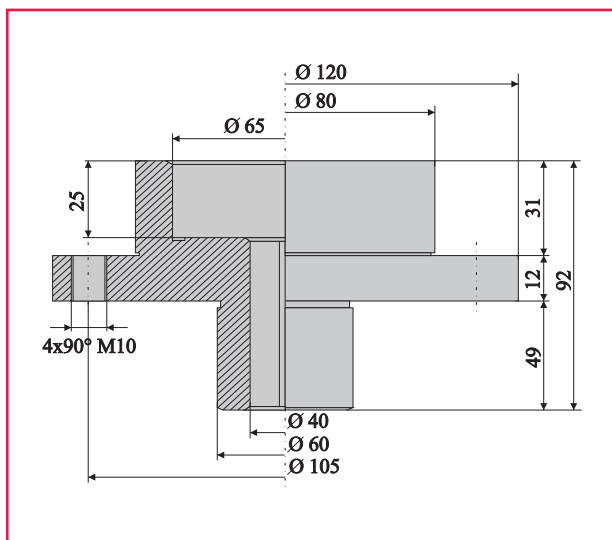

d	€
35	280,00
40	280,00

DA MONTARE SU ART. IM7 20  
TO BE ASSEMBLED ON ART. IM 720  
A ASSEMBLER SUR ART. IM 720  
DE MONTAR SOBRE ART. IM 720

## RICAMBI - SPARE PARTS - PIECES DE RECHANGE - RECAMBIOS



FVM830

€ 3,00



FVTM612

€ 3,00



FCM8

€ 5,00



FCTM6

€ 5,00

# TRUCIOLATORI A SETTORE IN HM

**GB** HW Trimming hogger  
with segments

**F** Déchiqueteurs avec  
segments en HW

**E** Desmenzadores  
con segmentos de HW

	D	B	d	Z lama princ.	N° sett	LT	COD DX-RH	COD SX-LH	€
□	200	30	35 KW	48-3	3	30/92	TC2003035K48D/A	TC2003035K48S/A	510,00
□	200	30	40 KW	48-3	3	30/92	TC2003040K48D/A	TC2003040K48S/A	510,00
□	200	30	35 KW	60-3	3	30/92	TC2003035K60D/A	TC2003035K60S/A	525,00
□	200	30	40 KW	60-3	3	30/92	TC2003040K60D/A	TC2003040K60S/A	525,00
△	250	30	60	40	4	35	TC250306040D/A	TC250306040S/A	475,00
△	250	30	80	40	4	35	TC250308040D/A	TC250308040S/A	475,00
△	250	30	60	60-4	4	35	TC250306060D/A	TC250306060S/A	480,00
△	250	30	80	60-4	4	35	TC250308060D/A	TC250308060S/A	480,00
△	250	30	60	80-4	4	35	TC250306080D/A	TC250306080S/A	500,00
△	250	30	80	80-4	4	35	TC250308080D/A	TC250308080S/A	500,00
□	250	50	60	42	3	51	TC250506042D/A	TC250506042S/A	615,00
□	250	50	80	42	3	51	TC250508042D/A	TC250508042S/A	615,00
□	250	50	60	60-3	3	51	TC250506060D/A	TC250506060S/A	620,00
□	250	50	80	60-3	3	51	TC250508060D/A	TC250508060S/A	620,00
□	250	50	60	81-3	3	51	TC250506081D/A	TC250506081S/A	645,00
□	250	50	80	81-3	3	51	TC250508081D/A	TC250508081S/A	645,00
△	300	30	60	48	6	35	TC300306048D/A	TC300306048S/A	665,00
△	300	30	80	48	6	35	TC300308048D/A	TC300308048S/A	665,00
△	300	30	60	72-6	6	35	TC300306072D/A	TC300306072S/A	675,00
△	300	30	80	72-6	6	35	TC300308072D/A	TC300308072S/A	675,00
△	300	30	60	96-6	6	35	TC300306096D/A	TC300306096S/A	695,00
△	300	30	80	96-6	6	35	TC300308096D/A	TC300308096S/A	695,00
□	300	50	60	44	4	51	TC300506044D/A	TC300506044S/A	845,00
□	300	50	80	44	4	51	TC300508044D/A	TC300508044S/A	845,00
□	300	50	60	72-4	4	51	TC300506072D/A	TC300506072S/A	850,00
□	300	50	80	72-4	4	51	TC300508072D/A	TC300508072S/A	850,00
□	300	50	60	96-4	4	51	TC300506096D/A	TC300506096S/A	860,00
□	300	50	80	96-4	4	51	TC300508096D/A	TC300508096S/A	860,00
□	350	30	60	56	8	35	TC350306056D/A	TC350306056S/A	970,00
□	350	30	80	56	8	35	TC350308056D/A	TC350308056S/A	970,00
□	350	30	60	80	8	35	TC350306080D/A	TC350306080S/A	980,00
□	350	30	80	80	8	35	TC350308080D/A	TC350308080S/A	980,00
□	350	50	60	56	4	51	TC350506056D/A	TC350506056S/A	1195,00
□	350	50	80	56	4	51	TC350508056D/A	TC350508056S/A	1195,00
□	350	50	60	80	4	51	TC350506080D/A	TC350506080S/A	1210,00
□	350	50	80	80	4	51	TC350508080D/A	TC350508080S/A	1210,00

I  
M  
7  
2  
2  
7  
2  
3  
7  
2  
4  
7  
2  
5

## RICAMBI PER IM 720 IN HM

HW SPARES FOR IM 720 / RECHANGES POUR IM 720 EN HW / REPUESTOS PARA IM 720 DE HW

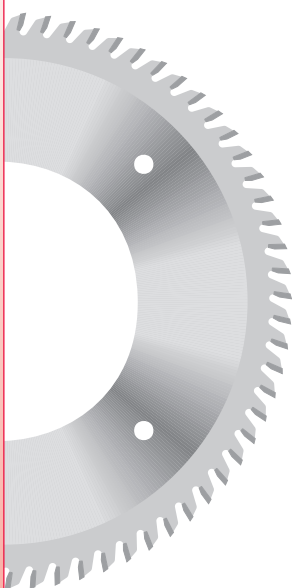

### CIRCOLARE PER TRUCIOLATORI

CIRCULAR SAW BLADE FOR TRIMMING HOGGERS  
LAME DE SCIE CIRCULAIRE POUR DÉCHIQUETEURS  
HOJA DE SIERRA PARA DESMENUZADORES

B=30

	D	B	b	d	Z	COD DX-RH	COD SX-LH	€
○	205	4,1	2,8	80+3	48-3	TL2054180F48D/A	TL2054180F48S/A	78,50
○	205	4,1	2,8	80+3	60-3	TL2054180F60PD/A	TL2054180F60PS/A	81,20
○	255	4,1	2,8	130+4	40	TL25541130F40D/A	TL25541130F40S/A	73,90
○	255	4,1	2,8	130+4	60-4	TL25541130F60PD/A	TL25541130F60PS/A	75,30
○	255	4,1	2,8	130+4	80-4	TL25541130F80PD/A	TL25541130F80PS/A	94,90
○	305	4,1	2,8	155+6	48	TL30541155F48D/A	TL30541155F48S/A	89,90
○	305	4,1	2,8	155+6	72-6	TL30541155F72PD/A	TL30541155F72PS/A	98,50
○	305	4,1	2,8	155+6	96-6	TL30541155F96PD/A	TL30541155F96PS/A	112,20
○	350	4,1	2,8	155+8	56	TL35041155F56D/A	TL35041155F56S/A	122,50
○	350	4,1	2,8	155+8	80	TL35041155F80D/A	TL35041155F80S/A	132,00



### SETTORE PER TRUCIOLATORI

TRIMMING HOGGER SEGMENTS  
SEGMENTS POUR DÉCHIQUETEURS  
SEGMENTOS PARA DESMENUZADORES

B=30

	D	B	b	Z	COD DX-RH	COD SX-LH	€
○	200	6,2	2,8	7	TS200627D/A	TS200627S/A	54,60
○	250	6,2	2,8	7	TS250627D/A	TS250627S/A	54,60
○	300	6,2	2,8	7	TS300627D/A	TS300627S/A	54,60
○	350	6,2	2,8	7	TS350627D/A	TS350627S/A	54,60

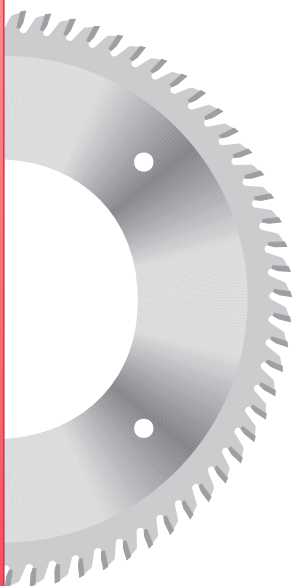

### CIRCOLARE PER TRUCIOLATORI

CIRCULAR SAW BLADE FOR TRIMMING HOGGERS  
LAME DE SCIE CIRCULAIRE POUR DÉCHIQUETEURS  
HOJA DE SIERRA PARA DESMENUZADORES

B=50

	D	B	b	d	Z	COD DX-RH	COD SX-LH	€
○	255	4,1	2,8	130+4	42	TL25541130F42D/A	TL25541130F42S/A	85,00
○	255	4,1	2,8	130+4	60-3	TL25541130F60PD/A1	TL25541130F60PS/A1	95,00
○	255	4,1	2,8	130+4	81-3	TL25541130F81PD/A	TL25541130F81PS/A	110,00
○	305	4,1	2,8	155+6	44	TL30541155F44D/A	TL30541155F44S/A	100,00
○	305	4,1	2,8	155+6	72-4	TL30541155F72PD/A1	TL30541155F72PS/A1	110,00
○	305	4,1	2,8	155+6	96-4	TL30541155F96PD/A1	TL30541155F96PS/A1	125,00
○	350	4,1	2,8	155+8	56	TL35041155F56D/A	TL35041155F56S/A	122,50
○	350	4,1	2,8	155+8	80	TL35041155F80D/A	TL35041155F80S/A	132,00



### SETTORE PER TRUCIOLATORI

TRIMMING HOGGER SEGMENTS  
SEGMENTS POUR DÉCHIQUETEURS  
SEGMENTOS PARA DESMENUZADORES

B=50

	D	B	b	Z	COD DX-RH	COD SX-LH	€
○	250	6,2	2,8	13	TS2506213D/A1	TS2506213S/A1	96,00
○	300	6,2	2,8	13	TS3006213D/A1	TS3006213S/A1	96,00
○	350	6,2	2,8	12	TS3506212D/A1	TS3506212S/A1	96,00

IM



## RICAMBI PER IM 720 IN PCD

PCD SPARES FOR IM 720

RECHANGES POUR IM 720 EN PCD

REPUESTOS PARA IM 720 DE PCD

726

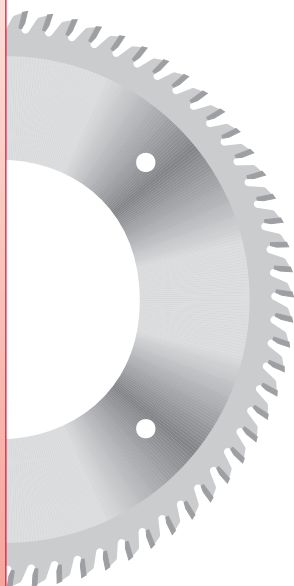

### LAMA PRINCIPALE IN PCD H=6

MAIN PCD SAW BLADE H=6

SCIE CIRCULAIRE PRINCIPALE EN PCD H=6

HOJA PRINCIPALE DE PCD H=6

D	B	b	d	fori	Z	COD DX-RH	COD SX-LH	€	
<b>B=30</b>									
<input type="checkbox"/>	205	4,2	2,8	80	3	48-3	TLD2054280F48PD/A	TLD2054280F48PS/A	1098,00
<input type="checkbox"/>	205	4,2	2,8	80	3	60-3	TLD2054280F60PD/A	TLD2054280F60PS/A	1390,80
<input type="checkbox"/>	255	4,2	2,8	130	4	40	TLD25542130F40D/A	TLD25542130F40S/A	976,00
<input type="checkbox"/>	255	4,2	2,8	130	4	60-4	TLD25542130F60PD/A	TLD25542130F60PS/A	1366,40
<input type="checkbox"/>	305	4,2	2,8	155	6	48	TLD30542155F48D/A	TLD30542155F48S/A	1171,20
<input type="checkbox"/>	305	4,2	2,8	155	6	72-6	TLD30542155F72PD/A	TLD30542155F72PS/A	1610,40
<input type="checkbox"/>	350	4,2	2,8	155	8	56	TLD35542155F56D/A	TLD35542155F56S/A	1366,40
<input type="checkbox"/>	350	4,2	2,8	155	8	80	TLD35542155F80D/A	TLD35542155F80S/A	1952,00
<b>B=50</b>									
<input type="checkbox"/>	255	4,2	2,8	130	4	42	TLD25542130F42D/A	TLD25542130F42S/A	1024,80
<input type="checkbox"/>	255	4,2	2,8	130	4	60-3	TL25542130F60PD/A1	TL25542130F60PS/A1	1390,80
<input type="checkbox"/>	305	4,2	2,8	155	6	44	TL30542155F44D/A	TL30542155F44D/S	1073,60
<input type="checkbox"/>	305	4,2	2,8	155	6	72-4	TLD30542155F72PD/A1	TLD30542155F72PS/A1	1659,20
<input type="checkbox"/>	350	4,2	2,8	155	8	56	TL35042155F56D/A	TL35042155F56S/A	1366,40
<input type="checkbox"/>	350	4,2	2,8	155	8	80	TL35542155F80D/A	TL35542155F80S/A	1952,00

### SETTORE PER TRUCIOLATORI IN PCD

PCD TRIMMING HOGGER SEGMENTS WITH

SEGMENTS POUR DÉCHIQUETEURS EN PCD

SEGMENTOS PARA DESMENUZADORES DE PCD

D	B	b	Z(PCD+HM)	COD DX-RH	COD SX-LH	€	
<b>B=30</b>							
<input type="checkbox"/>	200	6,2	2,8	7 (1+6)	TSD2006271D/A	TSD2006271S/A	120,00
<input type="checkbox"/>	200	6,2	2,8	7 (2+5)	TSD2006272D/A	TSD2006272S/A	185,00
<input type="checkbox"/>	200	6,2	2,8	7 (3+4)	TSD2006273D/A	TSD2006273S/A	225,00
<input type="checkbox"/>	200	6,2	2,8	7 (7+0)	TSD2006277D/A	TSD2006277S/A	450,00
<input type="checkbox"/>	250	6,2	2,8	7 (1+6)	TSD2506271D/A	TSD2506271S/A	120,00
<input type="checkbox"/>	250	6,2	2,8	7 (2+5)	TSD2506272D/A	TSD2506272S/A	185,00
<input type="checkbox"/>	250	6,2	2,8	7 (3+4)	TSD2506273D/A	TSD2506273S/A	225,00
<input type="checkbox"/>	250	6,2	2,8	7 (7+0)	TSD2506277D/A	TSD2506277S/A	450,00
<input type="checkbox"/>	300	6,2	2,8	7 (1+6)	TSD3006271D/A	TSD3006271S/A	120,00
<input type="checkbox"/>	300	6,2	2,8	7 (2+5)	TSD3006272D/A	TSD3006272S/A	185,00
<input type="checkbox"/>	300	6,2	2,8	7 (3+4)	TSD3006273D/A	TSD3006273S/A	225,00
<input type="checkbox"/>	300	6,2	2,8	7 (7+0)	TSD3006277D/A	TSD3006277S/A	450,00
<input type="checkbox"/>	350	6,2	2,8	7 (1+6)	TSD3506271D/A	TSD3506271S/A	120,00
<input type="checkbox"/>	350	6,2	2,8	7 (2+5)	TSD3506272D/A	TSD3506272S/A	185,00
<input type="checkbox"/>	350	6,2	2,8	7 (3+4)	TSD3506273D/A	TSD3506273S/A	225,00
<input type="checkbox"/>	350	6,2	2,8	7 (7+0)	TSD3506277D/A	TSD3506277S/A	450,00
<b>B=50</b>							
<input type="checkbox"/>	250	6,2	2,8	13 (1+12)	TSD25062131D/A1	TSD25062131S/A1	165,00
<input type="checkbox"/>	250	6,2	2,8	13 (2+11)	TSD25062132D/A1	TSD25062132S/A1	230,00
<input type="checkbox"/>	250	6,2	2,8	13 (13+0)	TSD250621313D/A1	TSD250621313S/A1	825,00
<input type="checkbox"/>	300	6,2	2,8	13 (1+12)	TSD30062131D/A1	TSD30062131S/A1	165,00
<input type="checkbox"/>	300	6,2	2,8	13 (2+11)	TSD30062132D/A1	TSD30062132S/A1	230,00
<input type="checkbox"/>	300	6,2	2,8	13 (13+0)	TSD300621313D/A1	TSD300621313S/A1	825,00
<input type="checkbox"/>	350	6,2	2,8	12 (1+11)	TSD35062121D/A1	TSD35062121S/A1	165,00
<input type="checkbox"/>	350	6,2	2,8	12 (2+10)	TSD35062122D/A1	TSD35062122S/A1	230,00
<input type="checkbox"/>	350	6,2	2,8	12 (12+0)	TSD350621212D/A1	TSD350621212S/A1	770,00

SU RICHIESTA SONO DISPONIBILI ALTRE COMBINAZIONI TRA PCD E HM  
 ON REQUEST OTHER COMBINATIONS BETWEEN PCD AND HW CAN BE PROVIDED  
 SUR DEMANDE DES AUTRES COMBINAISONS ENTRE PCD ET HW SONT DISPONIBLES  
 SU PREGUNTA D'OTRAS COMBINACIONES ENTRE PCD Y HW ESTÁN DISPONIBLES



# TRUCIOLATORI A LAME IN HM O DIAMANTE PCD

**GB** Trimming hogger with HW or diamond PCD saw blades

**F** Déchiqueteurs avec lames en HW o en diamant PCD

**E** Desmenuzadores con hojas de HW o de diamante PCD



**CORPO IN ACCIAIO  
BODY IN STEEL  
CORPI IN ACIER  
CUERPOS DE ACERO**

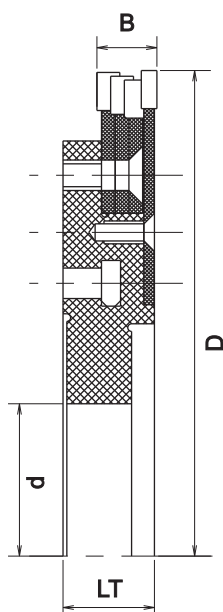

D	B	LT	d	Z	COD. DX-RX	COD. SX-LX	€
---	---	----	---	---	------------	------------	---

**RIPORTI HM/HW**

220	16	24	60	48+3x6	TC220166048BD	TC220166048BS	700,00
220	20	28	60	48+3x6	TC220206048BD	TC220206048BS	740,00
220	16	92	40 KW	48+3x6	TC2201640K48BD	TC2201640K48BS	965,00
220	20	92	40 KW	48+3x6	TC2202040K48BD	TC2202040K48BS	1010,00
250	16	24	80	56+3x8	TC250168056BD	TC250168056BS	730,00
250	20	28	80	56+3x8	TC250208056BD	TC250208056BS	780,00
250	16	92	40 KW	56+3x8	TC2501640K56BD	TC2501640K56BS	990,00
250	20	92	40 KW	56+3x8	TC2502040K56BD	TC2502040K56BS	1050,00

**DIAMANTE/PCD**

220	16	24	60	30+3x6	TD220166030BD	TD220166030BS	1830,00
220	20	28	60	30+3x6	TD220206030BD	TD220206030BS	1890,00
220	16	92	40 KW	30+3x6	TD2201640K30BD	TD2201640K30BS	2090,00
220	20	92	40 KW	30+3x6	TD2202040K30BD	TD2202040K30BS	2150,00
250	16	24	80	32+3x8	TD250168032BD	TD250168032BS	2120,00
250	20	28	80	32+3x8	TD250208032BD	TD250208032BS	2180,00
250	16	92	40 KW	32+3x8	TD2501640K32BD	TD2501640K32BS	2380,00
250	20	92	40 KW	32+3x8	TD2502040K32BD	TD2502040K32BS	2440,00

FORNITI SU RICHIESTA CON FORI PER ATTACCO RAPIDO - VEDI PU 401 PAG. 99  
 PROVIDES ON REQUEST WITH PIN HOLES FOR QUICK JUNCTURE - SEE PU 401 PAGE 99  
 FOURNIS SUR DEMANDE AVEC TROUS D'ENTRAÎNEMENT POUR JONCTURE RAPIDE - VOIR PU 401 PAGE 99  
 PROVEÏDOS SU PREGUNTA CON ORIFICIOS ARRASTRADOR POR JUNTURA RAPIDA - VER PU 401 PÁGINA 99

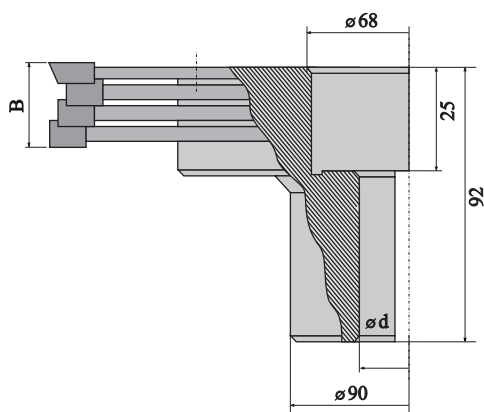

**POSSIBILITÀ  
DI LAVORAZIONE**

Assembling possibilities  
 Possibilité de montage  
 Posibilidad de trabajo

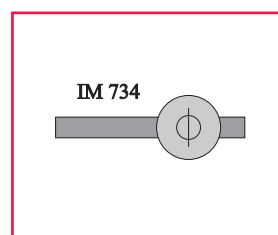
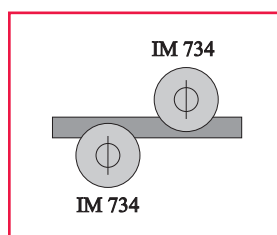
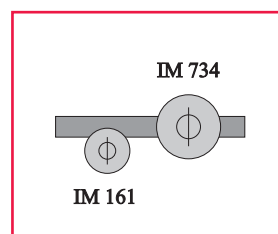



IM



## RICAMBI PER IM 734 IN HM O PCD

PCD OR HW SPARES FOR IM 734

RECHANGES POUR IM 734 EN HW O PCD

REPUESTOS PARA IM 734 DE HW O PCD

736

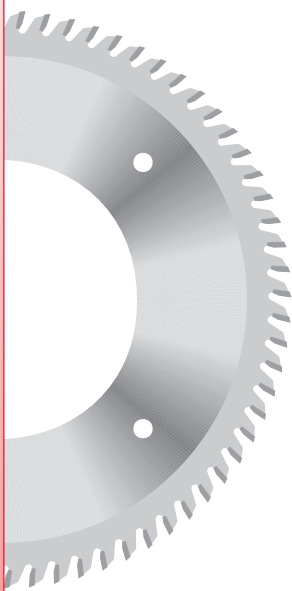

### LAMA PRINCIPALE IN HM O PCD H=6

MAIN HW OR PCD SAW BLADE H=6

SCIE CIRCULAIRE PRINCIPALE EN HW OU PCD H=6

HOJA PRINCIPALE DE HW O PCD H=6

D	B	b	d	fori	Z	COD DX-RH	COD SX-LH	€	
<b>HM/HW</b>									
□	225	4,1	2,8	110	6	48	TL22541110F48D	TL22541110F48S	73,80
□	225	4,1	2,8	130	6	60-6	TL22541110F60PD	TL22541110F60PS	78,40
○	255	4,1	2,8	130	6	40	TL25541130F40D	TL25541130F40S	73,90
○	255	4,1	2,8	130	6	56	TL25541130F56D	TL25541130F56S	79,40
○	255	4,1	2,8	130	6	80-8	TL25541130F80PD	TL25541130F80PS	95,50
<b>DIAMANTE/PCD</b>									
□	225	4,2	2,8	110	6	30	TLD22542110F30D	TLD22542110F30S	732,00
□	225	4,2	2,8	110	6	36	TLD22542110F36D	TLD22542110F36S	878,40
□	225	4,2	2,8	110	6	48	TLD22542110F48D	TLD22542110F48S	1171,20
□	255	4,2	2,8	130	6	32	TLD25542130F32D	TLD25542130F32S	780,80
□	255	4,2	2,8	130	6	40	TLD25542130F40D	TLD25542130F40S	976,00
□	255	4,2	2,8	130	6	48	TLD25542130F48D	TLD25542130F48S	1171,20
□	255	4,2	2,8	130	6	56	TLD25542130F56D	TLD25542130F56S	1366,40

737

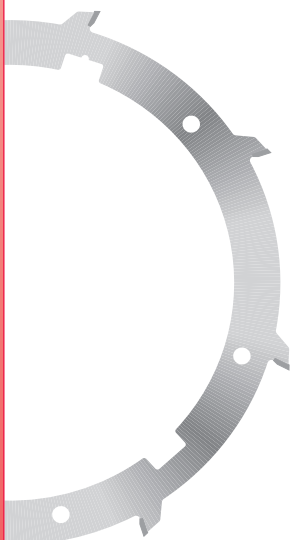

### LAMA TRUCIOLATRICE IN HM O PCD H=6

HW OR PCD CHIPPING CIRCULAR SAW BLADE H=6

SCIE CIRCULAIRE POUR RÉDUIRE EN COUPEAUX EN HW OU PCD H=6

HOJA DESMENUZADORA DE HW O PCD H=6

Truciolatore	Lama	D	Z	COD DX-RH	COD SX-LH	€	
<b>HM/HW</b>							
□	220	1	220	6	TA2201D	TA2201S	46,00
□		2	222	6	TA2202	TA2202	40,00
□		3	224	6	TA2203	TA2203	40,00
○	250	1	250	8	TA2501D	TA2501S	48,00
○		2	252	8	TA2502	TA2502	42,00
○		3	254	8	TA2503	TA2503	42,00
<b>DIAMANTE/PCD</b>							
□	220	1	220	6	TAD2201D	TAD2201S	250,00
□		2	222	6	TAD2202	TAD2202	250,00
□		3	224	6	TAD2203	TAD2203	250,00
□	250	1	250	8	TAD2501D	TAD2501S	325,00
□		2	252	8	TAD2502	TAD2502	325,00
□		3	254	8	TAD2503	TAD2503	325,00

738

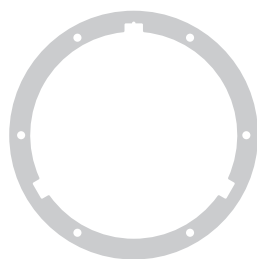

### ANELLO FONNO-ASSORBENTE

LOW NOISE RING / BAGUE POUR RÉDUIRE LE BRUIT / ANILLO FONNO-ABSORBENTE

Truciolatore	COD DX-RH	COD SX-LH	€
□	220	TF220	14,00
○	250	TF250	14,00



# TRUCIOLATORE IN DIAMANTE PCD

**GB** PCD diamond trimming hogger

**F** Déchiqueteur en diamant PCD

**E** Triturador en diamante PCD



**DIAMANTE/PCD H=6**

TIPOLOGIA DEL DENTE  
TOOTH TYPE  
TYPOLOGIE DU DENT  
TIPO DE DIENTE

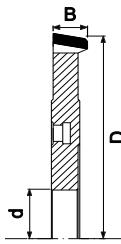

TIPO T Trasversale  
TYPE T Cross cut  
TYPE T Trasversal  
TIPO T Trasversal

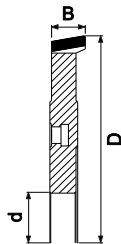

TIPO L Longitudinale  
TYPE L Length cut  
TYPE L Longitudinal  
TIPO L Longitudinal

Truciolatore compatto in diamante PCD con tagliente ad angolo mordente positivo, adatto per lavorazioni di pannelli truciolari, nobilitati, laminati, M.D.F., lavorazioni di pavimenti in silicato di calcio, utilizzabile su macchine squadratrici e squadrabordatrici. Corpo in acciaio ad alta resistenza.

Compact hogger in diamond with positive cut angle, suitable for working on chipboard panels, laminated, M.D.F., calcium silicate flooring, it can be used on squaring machines and squaring-edging machines. Steel body with a high resistance.

Déchiqueteur compact en diamant, tranchants à angle d'axe positif, pour l'usinage des panneaux de particules, revêtus, laminés et panneaux M.D.F, pour l'usinage des parquets en silicate de calcium, utilisable sur équarisseuses ou façonneuses-plaqueuses automatiques. Corps en acier à haute résistance

Triturador compacto en diamante con corte a ángulo positivo, adecuado para trabajar en paneles de aglomerados revestidos, laminados, M.D.F., suelo en silicato de calcio, utilizable con máquinas para escuadrar y combinada escuadradora/chapadora. Cuerpo en acero de alta resistencia.

	D	B	d	Z	COD. DX-RX	COD. SX-LX	€
□	220	16	60	30+6+6	TD220166042D	TD220166042S	1560,00
□	220	16	80	30+6+6	TD220168042D	TD220168042S	1560,00
□	220	16	60	36+6+6	TD220166048D	TD220166048S	1872,00
□	220	16	80	36+6+6	TD220168048D	TD220168048S	1872,00
□	250	20	60	30+6+6	TD250206042D	TD250206042S	1560,00
□	250	20	80	30+6+6	TD250208042D	TD250208042S	1560,00
□	250	20	60	36+6+6	TD250206048D	TD250206048S	1872,00
□	250	20	80	36+6+6	TD250208048D	TD250208048S	1872,00
□	250	20	60	42+6+6	TD250206054D	TD250206054S	2184,00
□	250	20	80	42+6+6	TD250208054D	TD250208054S	2184,00
□	250	20	60	48+6+6	TD250206060D	TD250206060S	2469,00
□	250	20	80	48+6+6	TD250208060D	TD250208060S	2469,00
□	250	20	60	54+6+6	TD250206066D	TD250206066S	2808,00
□	250	20	80	54+6+6	TD250208066D	TD250208066S	2808,00

FORNITI SU RICHIESTA CON FORI PER ATTACCO RAPIDO - VEDI PU 401 PAG. 99

PROVIDES ON REQUEST WITH PIN HOLES FOR QUICK JUNCTURE - SEE PU 401 PAGE 99

FURNIS SUR DEMANDE AVEC TROUS D'ENTRAÎNEMENT POUR JONCTURE RAPIDE - VOIR PU 401 PAGE 99

PROVEÏDOS SU PREGUNTA CON ORIFICIOS ARRASTRADOR POR JUNTURA RAPIDA - VER PU 401 PÁGINA 99

positivo / positive  
positif / positif

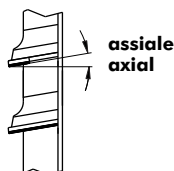

## POSSIBILITA' DI LAVORAZIONE

Assembling possibilities / Possibilité de montage / Posibilidad de trabajo

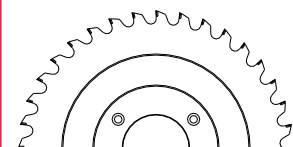
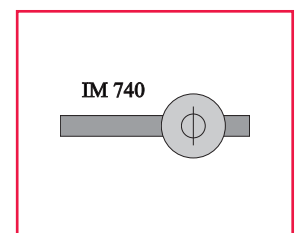
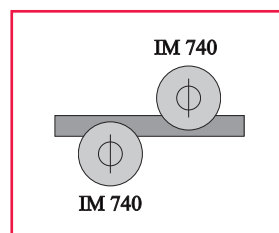
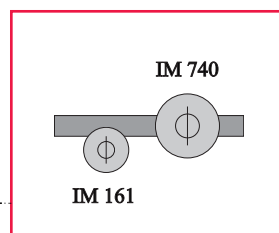



# TRUCIOLATORE RAGGIATO IN DIAMANTE PCD

**GB** PCD diamond radial  
trimming hogger

**F** Déchiqueteur radiaire  
en diamant PCD

**E** Triturador redondo  
en diamante PCD



**DIAMANTE/PCD H=6**

TIPOLOGIA DEL DENTE  
TOOTH TYPE  
TYPOLOGIE DU DENTS  
TIPO DE DIENTE

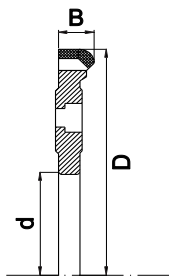

negativo / negative  
negatif / negativo

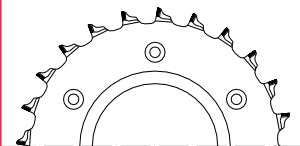

Trucioloare raggiato in diamante PCD, alto rendimento, profilo costante, adatto per lavorazioni di pannelli truciolari, nobilitati, laminati, utilizzabile su macchine squadratrici e squadraboardatrici. Ottima finitura. Corpo in acciaio ad alta resistenza.

Radius hogger in diamond, high performance, suitable for working on chipboard panels, laminated, it can be used on squaring machines and squaring/edging machines. Excellent finishing. Steel body with a high resistance.

Déchiqueteur rayonné en diamant, à haut rendement, profil constant, pour l'usinage des panneaux de particules, revêtus, laminés, utilisable sur équarisseuses et façonneuses-plaqueuses automatiques. Excellente finition. Corps en acier à haute résistance.

Triturador de corte redondo en diamante, alto rendimiento, perfil constante, adecuado para trabajar en paneles de aglomerados revestidos, laminados, utilizable con máquinas para escuadrar y combinada escuadradora/chapadora. Óptimo acabado. Cuerpo en acero de alta resistencia.

	D	B	d	Z	COD. DX-RX	COD. SX-LX	€
<input type="checkbox"/>	220	16	60	24+4	TD220166028D	TD220166028S	1872,00
<input type="checkbox"/>	220	16	80	24+4	TD220168028D	TD220168028S	1872,00
<input type="checkbox"/>	220	16	60	28+4	TD220166032D	TD220166032S	2184,00
<input type="checkbox"/>	220	16	80	28+4	TD220168032D	TD220168032S	2184,00
<input type="checkbox"/>	250	16	60	24+4	TD250166028D	TD250166028S	1872,00
<input type="checkbox"/>	250	16	80	24+4	TD250168028D	TD250168028S	1872,00
<input type="checkbox"/>	250	16	60	28+4	TD250166032D	TD250166032S	2184,00
<input type="checkbox"/>	250	16	80	28+4	TD250168032D	TD250168032S	2184,00
<input type="checkbox"/>	250	16	60	32+4	TD250166036D	TD250166036S	2496,00
<input type="checkbox"/>	250	16	80	32+4	TD250168036D	TD250168036S	2496,00
<input type="checkbox"/>	250	16	60	36+6	TD250166042D	TD250166042S	2808,00
<input type="checkbox"/>	250	16	80	36+6	TD250168042D	TD250168042S	2808,00

FORNITI SU RICHIESTA CON FORI PER ATTACCO RAPIDO - VEDI PU 401 PAG. 99

PROVIDES ON REQUEST WITH PIN HOLES FOR QUICK JUNCTURE - SEE PU 401 PAGE 99

FOURNIS SUR DEMANDE AVEC TROUS D'ENTRAÎNEMENT POUR JONCTURE RAPIDE - VOIR PU 401 PAGE 99

PROVEÍDOS SU PREGUNTA CON ORIFICIOS ARRASTRADOR POR JUNTURA RAPIDA - VER PU 401 PÁGINA 99

## POSSIBILITA' DI LAVORAZIONE

Assembling possibilities / Possibilité de montage / Posibilidad de trabajo

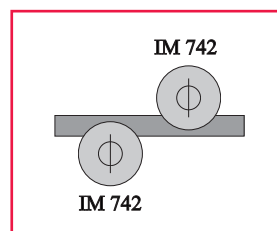

# ATTACCHI RAPIDI PNEUMATICI CORPO UNICO



**GB** Quick pneumatic  
junctions with  
unique body

**F** Junctions rapides  
pneumatiques  
avec corps unique

**E** Junturas rápidas  
neumáticas  
con cuerpo único

SISTEMA PNEUMATICO PER LA SOSTITUZIONE RAPIDA DEGLI UTENSILI  
 PNEUMATIC SYSTEM FOR THE QUICK SUBSTITUTION OF THE TOOLS  
 SYSTEME PNEUMATIQUE POUR LE REMPLACEMENT RAPIDE DES OUTILS  
 SISTEMA NEUMÁTICO POR EL REEMPLAZO RAPIDO DE LAS HERRAMIENTAS

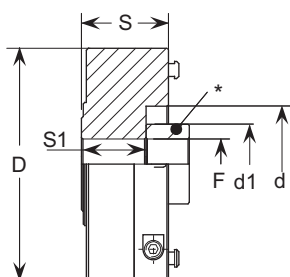

D	S	S1	F	perni	d	d1	COD	€
160	60	44,5	35	4/130	80		PM1603580	*
160	60	44,5	40	4/130	80		PM1604080	*
*160	60	44,5	35	4/130	80	60	PM1603560	*
*160	60	44,5	40	4/130	80	60	PM1604060	*

\* OTTENUTO AGGIUNGENDO UNA BUSSOLA  
 OBTAINED ADDING A COMPASS  
 OBTENU AJOUTENT UN COMPAS  
 OBTENIDO AÑADIENDO UNA BRÚJULA

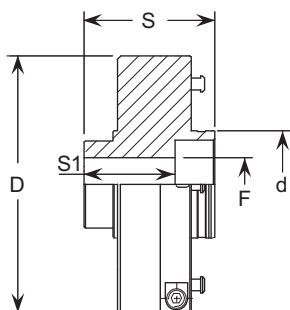

D	S	S1	F	perni	d	COD	€
192	90	68	35	4/150	80	PM1923580	*
192	90	68	40	4/150	80	PM1924080	*

ATTACCO RAPIDO CON TRUCIOLATORE  
 QUICK JUNCTURES WITH TRIMMING HOGGER  
 JUNCTION RAPIDE AVEC DÉCHIQUETEURS  
 JUNTURA RÁPIDA CON DESMENUZADORES



## RICAMBI - SPARE PARTS - PIECES DE RECHANGE - RECAMBIOS

RACCORDO PNEUMATICO / PNEUMATIC FILLETT / EMBOUT PNEUMATIQUE / JUNTURA NEUMÀTICA

€ \*

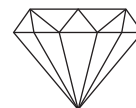

### Lame universali

Universal saw blades  
Lames universelles  
Hojas universales

#### IM 210

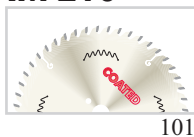

### Lame e incisori per sezionatrici

Diving saw blades and scorers  
Lame et inciseurs pour panneaux  
Hojas y incisores para despieadoras

#### IM 220



#### IM 230



#### IM 240



### Lame per fibramento

PCD circular saw blades for cement fiber  
Lames circulaires en PCD pour la coupe de fibre de ciment  
Hojas de sierra en PCD para el corte de fibra de cemento

#### IM 260



### Lame speciali

Special saw blades  
Lames spéciaux  
Hojas especiales

#### IM 290



### Punte

Bits  
Mechas  
Brocas

#### PU 660

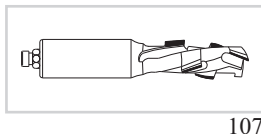

#### PU 661

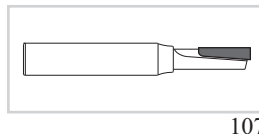

#### PU 662

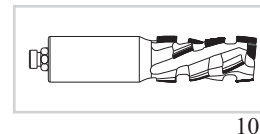

#### PU 663

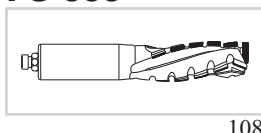

#### PU 664

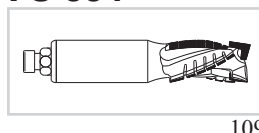

#### PU 665

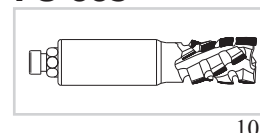

#### PU 666

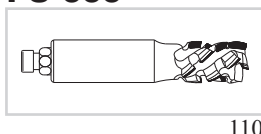

#### PU 667

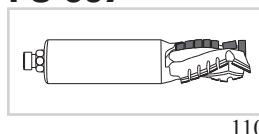

#### PU 668

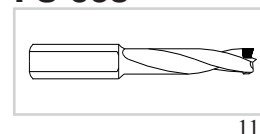

#### PU 669

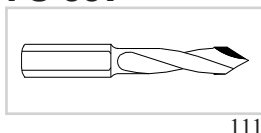

#### PU 670

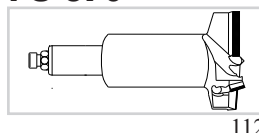

### Frese per rettificare

Jointing cutter  
Fraise à calibrer  
Antiastillia

#### FR 672

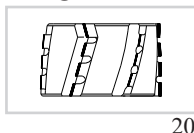

#### FR 673

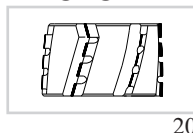

#### FR 674

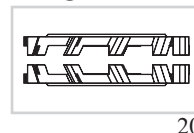



# LAMA CIRCOLARE UNIVERSALE IN PCD

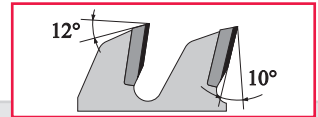

**GB** Universal circular saw blade in PCD

**F** Scie circulaire universelle in PCD

**E** Hoja de sierra para empleo universal in PCD

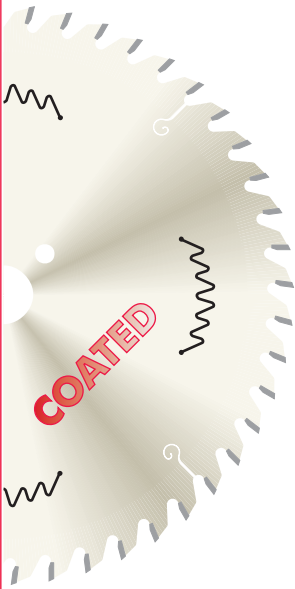

	D	B	b	d	●●●	Z	COD	€ H=4	€ H=6
<input type="checkbox"/>	250	3,2	2,2	30	PH2	40	LUD2503230F40	560,00	756,00
<input type="checkbox"/>	250	3,2	2,2	30	PH2	60	LUD2503230F60	840,00	1134,00
<input type="checkbox"/>	250	3,2	2,2	30	PH2	80	LUD2503230F80	1120,00	1512,00
<input type="checkbox"/>	300	3,2	2,2	30	PH2	48	LUD3003230F48	672,00	907,20
<input type="checkbox"/>	300	3,2	2,2	30	PH2	60	LUD3003230F60	840,00	1134,00
<input type="checkbox"/>	300	3,2	2,2	30	PH2	72	LUD3003230F72	1008,00	1360,80
<input type="checkbox"/>	300	3,2	2,2	30	PH2	96	LUD3003230F96	1344,00	1814,40
<input type="checkbox"/>	350	3,5	2,5	30	PH2	54	LUD3503530F54	815,40	1053,00
<input type="checkbox"/>	350	3,5	2,5	30	PH2	72	LUD3503530F72	1087,20	1404,00
<input type="checkbox"/>	350	3,5	2,5	30	PH2	84	LUD3503530F84	1268,10	1638,00
<input type="checkbox"/>	350	3,5	2,5	30	PH2	108	LUD3503530F108	1630,80	2106,00
<input type="checkbox"/>	400	4,0	2,8	30	2/10/60	48	LUD4004030F48	830,40	1118,40
<input type="checkbox"/>	400	4,0	2,8	30	2/10/60	60	LUD4004030F60	1038,00	1398,00
<input type="checkbox"/>	400	4,0	2,8	30	2/10/60	96	LUD4004030F96	1660,80	2236,80

SU RICHIESTA SI PRODUCONO MISURE SPECIALI - PER PREZZI VEDI PAG 106  
 ON REQUEST WE PRODUCE SPECIAL MEASURES - FOR PRICE SEE PAGE 106  
 SUR DEMANDE ON PRODUIT MESURES SPÉCIAUX - POUR LES PRIX VOIR PAGE 106  
 A DEMANDA PRODUCIMOS MEDIDAS ESPECIALES - POR LOS PRECIOS VER PAGINA 106

## FORMA DEI TAGLIANTI TEETH FORM FORME DE DENTURE FORME DE LOS DIENTES

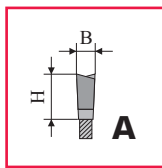

Dente alternato  
Alternate bevel tooth  
Denture alternée  
Diente alterno

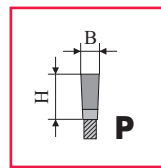

Dente piano  
Flat tooth  
Denture plate  
Diente recto

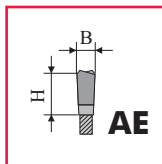

Dente alternato-sbozzatore  
Alternate-triple-chip tooth  
Denture alternée-trapézoidal  
Diente alterno-trapezoidal

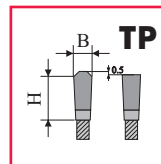

Dente trapezio-piano  
Trapezoidal-flat tooth  
Denture trapézoidal-plate  
Diente trapezoidal-recto

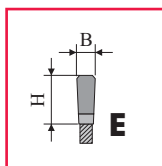

Dente sbozzatore  
Triple-chip tooth  
Denture trapézoidal  
Diente trapezoidal

# LAME CIRCOLARI PER SEZIONATRICE IN PCD H=6

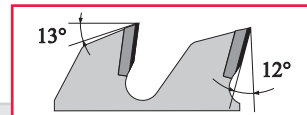
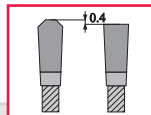

I  
M

**GB** Circular panel sizing saw blades  
in PCD H=6

**F** Lames de scie circulaire  
panneau de dimensionnement PCD

**E** Panel circular de tamaño  
hojas de sierra PCD

2  
2  
0

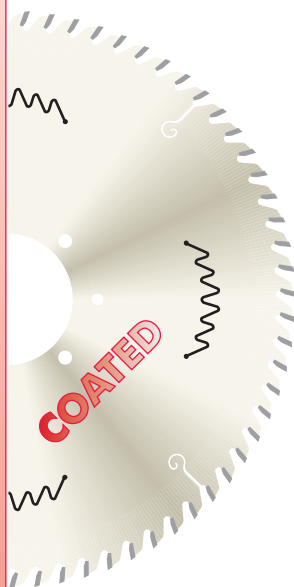

	D	B	b	d	●●●	Z	COD	€ H=6
<input type="checkbox"/>	300	4,4	3,2	30	PH2	60	LSD3004430F60T	1524,00
<input type="checkbox"/>	300	4,4	3,2	65	SELCO	60	LSD3004465F60T/A	1524,00
<input type="checkbox"/>	320	4,4	3,2	50	GIBEN	60	LSD3204450F60T	1524,00
<input type="checkbox"/>	320	4,4	3,2	65	SELCO	60	LSD3204465F60T/A	1524,00
<input type="checkbox"/>	330	4,4	3,2	50	GIBEN	60	LSD3304450F60T	1524,00
<input type="checkbox"/>	350	4,4	3,2	30	PH2	72	LSD3504430F72T	1828,80
<input type="checkbox"/>	350	4,4	3,2	50	GIBEN	72	LSD3504450F72T	1828,80
<input type="checkbox"/>	350	4,4	3,2	60	HOLZMA	72	LSD3504460F72T	1828,80
<input type="checkbox"/>	350	4,4	3,2	65	SELCO	72	LSD3504465F72T/A	1828,80
<input type="checkbox"/>	350	4,4	3,2	75	PH5	72	LSD3504475F72T	1828,80
<input type="checkbox"/>	350	4,4	3,2	80	PH4	72	LSD3504480F72T	1828,80
<input type="checkbox"/>	360	4,4	3,2	50	GIBEN	72	LSD3604450F72T	1828,80
<input type="checkbox"/>	360	4,4	3,2	65	SELCO	72	LSD3604465F72T/A	1828,80
<input type="checkbox"/>	370	4,4	3,2	30	SCCELLING	72	LSD3704430F72T	1828,80
<input type="checkbox"/>	380	4,8	3,5	60	HOLZMA	72	LSD3804860F72T	2016,00
<input type="checkbox"/>	400	4,4	3,2	30	2/10/60	72	LSD4004430F72T	1828,80
<input type="checkbox"/>	400	4,4	3,2	60	ANTHON	72	LSD4004460F72T/B	1828,80
<input type="checkbox"/>	400	4,4	3,2	75	GIBEN / HOMAG	72	LSD4004475F72T	1828,80
<input type="checkbox"/>	400	4,4	3,2	80	PH4	72	LSD4004480F72T	1828,80
<input type="checkbox"/>	400	4,8	3,5	60	HOLZMA	72	LSD4004860F72T	2016,00
<input type="checkbox"/>	420	4,8	3,5	60	HOLZMA	72	LSD4204860F72T	2016,00
<input type="checkbox"/>	430	4,4	3,2	75	GIBEN	72	LSD4304475F72T	1828,80
<input type="checkbox"/>	430	4,4	3,2	80	PH4	72	LSD4304480F72T	1828,80
<input type="checkbox"/>	450	4,4	3,2	30	SCHELLING	72	LSD4504430F72T	1828,80
<input type="checkbox"/>	450	4,4	3,2	80	PH4	72	LSD4504480F72T	1828,80
<input type="checkbox"/>	450	4,8	3,5	60	HOLZMA	72	LSD4504860F72T	2016,00
<input type="checkbox"/>	450	4,8	3,5	80	PH4	72	LSD4504880F72T	2016,00
<input type="checkbox"/>	460	4,4	3,2	30	SCHELLING	72	LSD4604430F72T	1828,80
<input type="checkbox"/>	470	4,4	3,2	75	GIBEN	72	LSD4704475F72T	1828,80
<input type="checkbox"/>	480	4,4	3,2	30	SCHELLING	72	LSD4804430F72T	1828,80
<input type="checkbox"/>	480	4,8	3,5	60	HOLZMA	72	LSD4804860F72T	2016,00
<input type="checkbox"/>	480	4,8	3,5	80	SELCO	72	LSD4804880F72T/A	2016,00
<input type="checkbox"/>	500	4,8	3,5	60	HOLZMA	72	LSD5004860F72T	2016,00
<input type="checkbox"/>	520	4,8	3,5	60	HOLZMA	60	LSD5204860F60T	1680,00

SU RICHIESTA SI PRODUCONO LAME CON  
ALTRE MISURE, AFFILATURE DIVERSE O SPECIALI E PCD CON H=4 E H=5  
PER PREZZI VEDI PAG. 106

ON REQUEST WE CAN PRODUCE CIRCULAR SAW BLADES  
WITH OTHER MEASURES, SHARPENING OR OTHER SPECIAL PCD WITH H=4 AND H=5  
FOR PRICE SEE PAGE 106

SUR DEMANDE ON PRODUIT DES LAMES AVEC D'AUTRES MESURES,  
AFFÛTAGES DIFFÉRENTES OU SPÉCIAUX PCD AVEC H=4 ET H=5  
POUR LES PRIX VOIR PAGE 106

SU PREGUNTA PRODUCIMOS HOJAS DE SIERRA CON OTRAS  
MEDIDAS, AFILADURAS DIFERENTES O ESPECIALES PCD CON H=4 Y H=5  
POR LOS PRECIOS VER PÁGINA 106

I  
M

2  
3  
0



# LAMA INCISORE CONICO PER SEZIONATRICE PCD H=4 E H=6

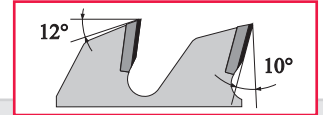
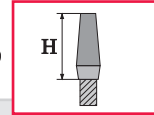

**GB** Dividing scoring saw blade PCD

**F** Inciseur pour le débit de panneaux PCD

**E** Incisor para el despiezado de tableros PCD



	D	B	b	d	•●•	Z	COD	€ H=4	€ H=6
<input type="checkbox"/>	100	3,2/3,8	2,2	20		20	LCD100322020	312,00	426,00
<input type="checkbox"/>	120	3,2/3,8	2,2	20		20	LCD120322020	312,00	426,00
<input type="checkbox"/>	120	3,2/3,8	2,2	22		20	LCD120322220	312,00	426,00
<input type="checkbox"/>	125	3,2/3,8	2,2	20		24	LCD125322024	374,40	511,20
<input type="checkbox"/>	125	3,2/3,8	2,2	22		24	LCD125322224	374,40	511,20
<input type="checkbox"/>	160	4,4/5,0	3,2	45	GIBEN	36	LCD1604445F36	738,00	1022,40
<input type="checkbox"/>	160	4,4/5,0	3,2	55	GABBIANI	36	LCD1604455F36	738,00	1022,40
<input type="checkbox"/>	180	4,4/5,0	3,2	20		36	LCD180442036	738,00	1022,40
<input type="checkbox"/>	180	4,4/5,0	3,2	45	HOLZMA	36	LCD180444536	738,00	1022,40
<input type="checkbox"/>	180	4,8/5,4	3,5	45	HOLZMA	36	LCD180484536	802,80	1112,40
<input type="checkbox"/>	180	5,8/6,4	4,0	20	ANTHON	36	LCD180582036/B	961,20	1335,60
<input type="checkbox"/>	180	4,4/5,0	3,2	50	GIBEN	44	LCD1804450F44	902,00	1249,60
<input type="checkbox"/>	200	4,4/5,0	3,2	20		36	LCD200442036	738,00	1022,40
<input type="checkbox"/>	200	4,4/5,0	3,2	30	2/10/60	36	LCD2004430F36	738,00	1022,40
<input type="checkbox"/>	200	4,4/5,0	3,2	45	HOLZMA	36	LCD200444536	738,00	1022,40
<input type="checkbox"/>	200	4,4/5,0	3,2	65	SELCO	36	LCD2004465F36/A	738,00	1022,40
<input type="checkbox"/>	200	4,8/5,4	3,5	45	HOLZMA	36	LCD200484536	802,80	1112,40
<input type="checkbox"/>	200	4,8/5,4	3,5	65	SELCO	36	LCD2004865F36/A	802,80	1112,40
<input type="checkbox"/>	200	5,0/5,6	3,5	20	SHELLING	36	LCD200502036	820,80	1162,80
<input type="checkbox"/>	200	5,8/6,4	4,0	45	HOLZMA	36	LCD200584536	961,20	1335,60
<input type="checkbox"/>	215	4,4/5,0	3,2	50	GIBEN	42	LCD2154450F42	861,00	1192,80

SU RICHIESTA SI PRODUCONO MISURE SPECIALI - PER PREZZI VEDI PAG. 106  
 ON REQUEST WE PRODUCE SPECIAL MEASURES - FOR PRICE SEE PAGE 106  
 SUR DEMANDE ON PRODUIT MESURES SPÉCIAUX - POUR LES PRIX VOIR PAGE 106  
 A DEMANDA PRODUCIMOS MEDIDAS ESPECIALES - POR LOS PECIOS VER PAGINA 106



I  
M

2  
4  
0



# LAMA INCISORE REGOLABILE PER SEZIONATRICI CON ANELLI DI REGOLAZIONE IN PCD H=4 E H=6

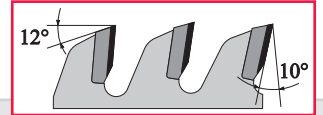

**GB** Adjustable dividing scoring saw blade complete with spacers PCD

**F** Inciseur a épaisseur réglable avec les bagues de réglage PCD

**E** Incisor regable para despieceado de tableros con anillos de regulacion PCD



	D	B	b	d	•●•	Z	COD	€ H=4	€ H=6
<input type="checkbox"/>	80	2,8/3,6	2,2	20		10+10	LDD8028362010	325,00	490,00
<input type="checkbox"/>	100	2,8/3,6	2,2	20		10+10	LDD10028362010	325,00	490,00
<input type="checkbox"/>	100	2,8/3,6	2,2	22		10+10	LDD10028362210	325,00	490,00
<input type="checkbox"/>	120	2,8/3,6	2,2	20		12+12	LDD12028362012	390,00	585,00
<input type="checkbox"/>	120	2,8/3,6	2,2	22		12+12	LDD12028362212	390,00	585,00
<input type="checkbox"/>	125	2,8/3,6	2,2	20		12+12	LDD12528362012	390,00	585,00
<input type="checkbox"/>	125	2,8/3,6	2,2	22		12+12	LDD12528362212	390,00	585,00
<input type="checkbox"/>	125	4,0/5,0	2,2	45	GIBEN	18+18	LDD12540504518	830,00	815,00

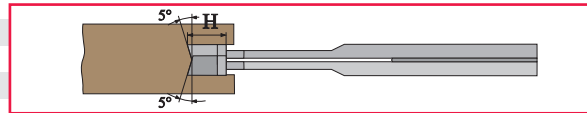

INCISORE PER ATTACCO RAPIDO SENZA ANELLI  
SCORING SAW BLADES ADJUSTMENT UNIT RAPIDO WITHOUT RINGS  
INCISER POUR JONCTION RAPIDE SANS BAGUES  
INCISOR PARA JUNTURA RÁPIDA SIN ANILLOS

<input type="checkbox"/>	120	2,8/3,8	2,2	50+4	ALTENDORF	12+12	LDD120283850F12	425,00	620,00
<input type="checkbox"/>	120	2,8/3,6	2,2	50+4	GDA	12+12	LDD120283650F12/A	425,00	620,00
<input type="checkbox"/>	125	2,8/3,6	2,2	50+4	GDA	12+12	LDD125283650F12/A	425,00	620,00
<input type="checkbox"/>	125	4,0/5,0	2,2	20+4+1	GABBIANI	18+18	LDD125405020F18	870,00	1300,00

I  
M

2  
6  
0



# LAME CIRCOLARI IN PCD PER TAGLIO MATERIALI ABRASIVI COME FIBRACIMENTO, ETERNIT, CARTONGESSO

**(GB)** PCD circular saw blades for the cutting of abrasive material, like cement fiber, eternit, plasterboards

**(F)** Lames circulaires en PCD pour la coupe de matérielles abrasifs comme fibre de ciment, eternit, placoplatre

**(E)** Hojas de sierra en PCD para el corte de materiales abrasivos como fibra de cemento, eternit, placas de yeso

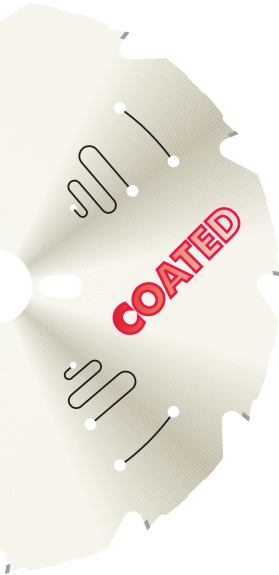

	D	B	b	d	●●●	Z	COD	€
□	160	2.4	1.6	20	2/6/32	4	LXD1602420F4	160,00
□	160	2.4	1.6	20	2/6/32	8	LXD1602420F8	225,00
□	190	2.4	1.6	20	2/6/32	4	LXD1902420F4	160,00
□	190	2.4	1.6	20	2/6/32	8	LXD1902420F8	225,00
□	200	2.4	1.6	30	2/7/42	4	LXD2002430F4	160,00
□	200	2.4	1.6	30	2/7/42	8	LXD2002430F8	225,00
□	216	2.4	1.6	30		8	LXD21624308	225,00
□	216	2.4	1.6	30		12	LXD216243012	300,00
□	230	2.4	1.6	30	2/7/42	6	LXD2302430F6	205,00
□	230	2.4	1.6	30	2/7/42	12	LXD2302430F12	300,00
□	250	2.4	1.6	30	PH2	6	LXD2502430F6	205,00
□	250	2.4	1.6	30	PH2	12	LXD2502430F12	300,00
□	300	2.4	1.6	30	PH2	12	LXD3002430F12	315,00
□	300	2.4	1.6	30	PH2	20	LXD3002430F20	450,00

ORDINE MINIMO 5 PCS  
PER ORDINI SUPERIORI AI 30 PCS CHIEDERE PREVENTIVO

MINIMUM ORDER 5 PIECES - FOR ORDERS WITH QUANTITY  
GREATER THAN 30 PCS, PLEASE ASK FOR A QUOTATION

ORDRE MINIMUM DE 5 PIÈCES - POUR ORDRES AVEC QUANTITÉS  
SUPÉRIEURES AUX 30 PIÈCES, DEMANDER UN DEVIS

PEDIDO MÍNIMO DE 5 PIEZAS - POR PEDIDOS CON CANTIDADES  
SUPERIORES A LAS 30 PIEZAS, PEDIR UN PRESUPUESTO

# LAME CIRCOLARI IN DIAMANTE PCD

**GB** Circular saw blade in PCD

**F** Scie circulaire in PCD

**E** Hoja de sierra in PCD

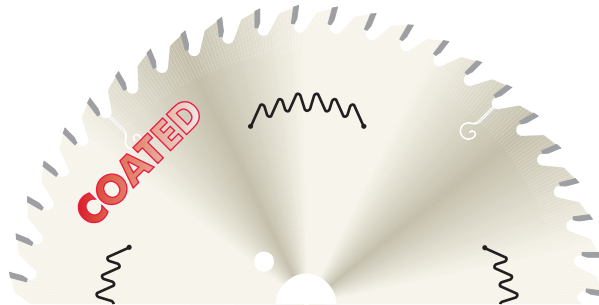
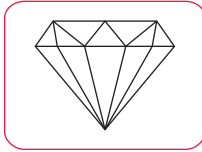

## LAMA PRINCIPALE / MAIN SAWBLADE

€ per dente / € for teeth

B	H=4mm	H=5mm	H=6mm
3.2	14,00	17,30	18,90
3.5	15,10	18,90	19,50
3.8	16,30	20,50	22,10
4.0	17,30	21,50	23,30
4.2	18,10	22,60	24,40
4.4	18,60	23,60	25,40
4.6	19,50	24,70	26,00
4.8	20,60	25,80	28,00
5.0	21,50	26,80	29,60
5.2	22,30	27,90	30,20
5.4	23,20	29,00	31,30
5.6	24,10	30,10	32,50
5.8	24,90	31,10	33,70
6.0	25,80	32,50	34,80

ESEMPIO: 300x3,2x30 Z=60 H=4 € 840,00

MINIMO Z=24 / MINIMUM Z=24  
DIAMETRO MASSIMO 500 / MAXIMUM DIAMETER 500

## INCISORE CONICO / CONIC SCORER

€ per dente / € for teeth

B	H=4mm	B	H=6mm
3.2/3.8	15,60	3.2/4.0	21,30
3.5/4.0	16,80	3.5/4.5	23,00
3.8/4.4	18,20	3.8/4.8	24,70
4.0/4.6	18,90	4.0/5.0	26,10
4.2/4.8	19,90	4.2/5.2	27,20
4.4/5.0	20,50	4.4/5.4	28,40
4.6/5.2	21,20	4.6/5.6	29,40
4.8/5.4	22,30	4.8/5.8	30,90
5.0/5.6	22,80	5.0/6.0	32,30
5.2/5.8	24,10	5.2/6.2	33,40
5.4/6.0	24,90	5.4/6.4	34,60
5.6/6.2	25,70	5.6/6.6	35,90
5.8/6.4	26,70	5.8/6.8	37,10

ESEMPIO: 180x4,4/5,4x45 Z=24 H=6 € 681,60

MINIMO Z=24 / MINIMUM Z=24

## FORMA DEI TAGLIANTI / TEETH FORM

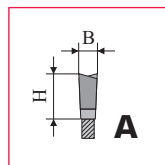

**A** Dente alternato  
Alternate bevel tooth  
Denture alternée  
Diente alternativo

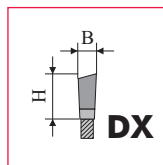

**DX** Dente destro  
Tooth with right-hand bevels  
Denture blaise à droite  
Diente biselados a la derecha

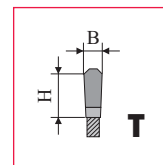

**T** Dente trapezoidale  
Trapezoidal tooth  
Denture trapézoïdale  
Diente trapezoidal

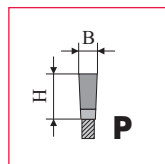

**P** Dente piano  
Flat tooth  
Denture plate  
Diente recto

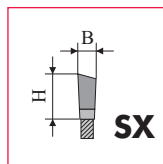

**SX** Dente sinistro  
Tooth with left-hand bevels  
Denture blaise à gauche  
Diente biselados a la izquierda

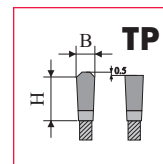

**TP** Dente trapezio-piano  
Trapezoidal-flat tooth  
Denture trapézoïdale-plate  
Diente trapezoidal-recto

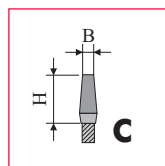

**C** Dente conico  
Conical tooth  
Denture conique  
Diente conico

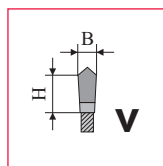

**V** Dente a punta  
Pointed tooth  
Denture pointue  
Diente en punta

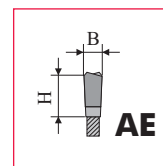

**AE** Dente alternato - sbozzatore  
Alternate - triple - chip tooth  
Denture alternée-trapézoïdale  
Diente alternativo-trapezoidal

P  
U6  
6  
0GDA  
High-tech tools

## PUNTE IN DIAMANTE PER PANTOGRAFO

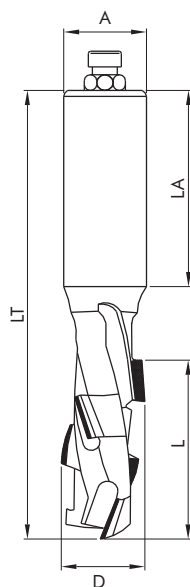
DIAMANTE/PCD  
H=2,5 Z=1+1GB Diamond  
router bitF Meche a defoncer  
avec diamantE Broca para fresadora  
con diamante

D	L	LT	AxLA	N DIA	DX-RX	SX-LX	€
12	25	75	12x40	3+1	PD120253D	PD120253S	98,00
12	34	85	12x40	4+1	PD120344D	PD120344S	130,00
16	25	85	16x50	3+1	PD160253D	PD160253S	98,00
16	34	94	16x50	4+1	PD160344D	PD160344S	130,00
16	43	103	16x50	5+1	PD160435D	PD160435S	163,00
18	25	85	20x50	3+1	PD180253D	PD180253S	98,00
18	34	94	20x50	4+1	PD180344D	PD180344S	130,00
18	43	103	20x50	5+1	PD180435D	PD180435S	163,00
20	25	85	20x50	3+1	PD200253D	PD200253S	98,00
20	34	94	20x50	4+1	PD200344D	PD200344S	130,00
20	43	103	20x50	5+1	PD200435D	PD200435S	163,00
20	52	112	20x50	6+1	PD200526D	PD200526S	195,00
20	61	121	20x50	7+1	PD200617D	PD200617S	228,00

+1=HM/HW

## PUNTE IN DIAMANTE PER PANTOGRAFO

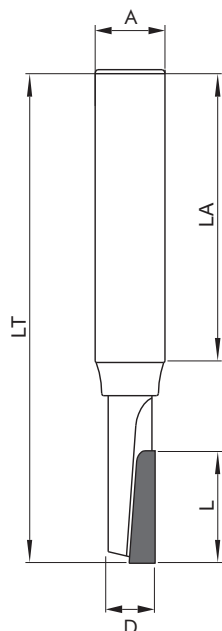
DIAMANTE/PCD  
Z=1GB Diamond  
router bitF Meche a defoncer  
avec diamantE Broca para fresadora  
con diamante

D	L	LT	AxLA	N DIA	DX-RX	SX-LX	€
5	10	60	6x40	1	PD050101D	PD050101S	114,00
6	12	60	6x40	1	PD060121D	PD060121S	98,00
7	12	60	8x40	1	PD070121D	PD070121S	114,00
8	12	65	8x40	1	PD080121D	PD080121S	114,00
9	12	65	8x40	1	PD090121D	PD090121S	146,00
10	15	70	10x40	1	PD100151D	PD100151S	146,00
12	20	70	10x40	1	PD120201D	PD120201S	179,00

GDA  
High-tech tools

P  
U

6  
6  
2



## PUNTE IN DIAMANTE PER PANTOGRAFO



**DIAMANTE/PCD**  
**H=2,5 Z=2+1**



Diamond router bit



Meche a defoncer avec diamant



Broca para fresadora con diamante

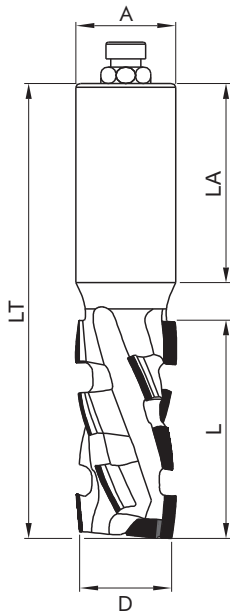

D	L	LT	AxLA	N DIA	DX-RX	SX-LX	€
12	25	75	12x40	6+1	PD120256D	PD120256S	195,00
16	25	85	16x50	6+1	PD160256D	PD160256S	195,00
16	34	94	16x50	8+1	PD160348D	PD160348S	260,00
18	25	85	20x50	6+1	PD180256D	PD180256S	195,00
18	34	94	20x50	8+1	PD180348D	PD180348S	260,00
18	43	103	20x50	10+1	PD1804310D	PD1804310S	325,00
20	25	85	20x50	6+1	PD200256D	PD200256S	195,00
20	34	94	20x50	8+1	PD200348D	PD200348S	260,00
20	43	103	20x50	10+1	PD2004310D	PD2004310S	325,00
20	52	112	20x50	12+1	PD2005212D	PD2005212S	390,00
20	61	121	20x50	14+1	PD2006114D	PD2006114S	455,00

+1=HM/HW

## PUNTE IN DIAMANTE PER PANTOGRAFO



**DIAMANTE/PCD**  
**H=2,5 Z=2+1**



Diamond router bit



Meche a defoncer avec diamant



Broca para fresadora con diamante

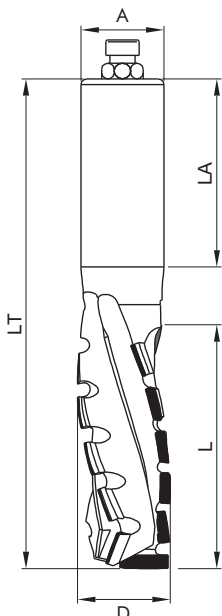

D	L	LT	AxLA	N DIA	DX-RX	SX-LX	€
12	27	75	12x40	7+1	PD120277D	PD120277S	228,00
12	36	85	12x40	9+1	PD120369D	PD120369S	293,00
16	27	86	16x50	7+1	PD160277D	PD160277S	228,00
16	36	95	16x50	9+1	PD160369D	PD160369S	293,00
16	45	105	16x50	12+1	PD1604512D	PD1604512S	390,00
18	36	95	20x50	9+1	PD180369D	PD180369S	293,00
18	45	105	20x50	12+1	PD1804512D	PD1804512S	390,00
20	56	116	20x50	15+1	PD2005615D	PD2005615S	488,00
22	67	127	20x50	18+1	PD2206718D	PD2206718S	585,00

+1=HM/HW



P  
U

6  
6  
4



## PUNTE IN DIAMANTE PER PANTOGRAFO



**DIAMANTE/PCD**  
**H=4,5 Z=3+1**



Diamond router bit



Meche a defoncer avec diamant



Broca para fresadora con diamante

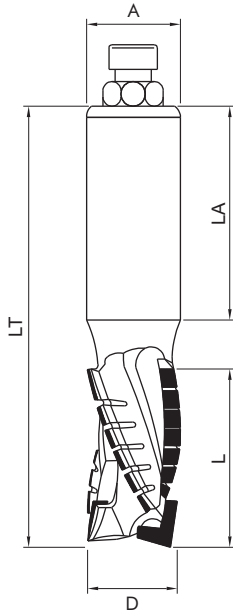

D	L	LT	AxLA	N DIA	DX-RX	SX-LX	€
22	32	94	20x50	18	PD2203218D	PD2203218S	438,00
22	37	99	20x50	21	PD2203721D	PD2203721S	552,00
25	27	97	25x55	15	PD2502715D	PD2502715S	374,00
25	32	102	25x55	18	PD2503218D	PD2503218S	438,00
25	37	107	25x55	21	PD2503721D	PD2503721S	552,00
25	42	112	25x55	24	PD2504224D	PD2504224S	650,00
25	47	117	25x55	27	PD2504727D	PD2504727S	731,00
25	52	122	25x55	30	PD2505230D	PD2505230S	764,00
25	58	128	25x55	33	PD2505833D	PD2505833S	877,00
25	63	133	25x55	36	PD2506336D	PD2506336S	975,00
25	68	138	25x55	39	PD2506839D	PD2506839S	1.040,00

P  
U

6  
6  
5



## PUNTE IN DIAMANTE PER PANTOGRAFO



**DIAMANTE/PCD**  
**H=4,5 Z=2+1**



Diamond router bit



Meche a defoncer avec diamant



Broca para fresadora con diamante

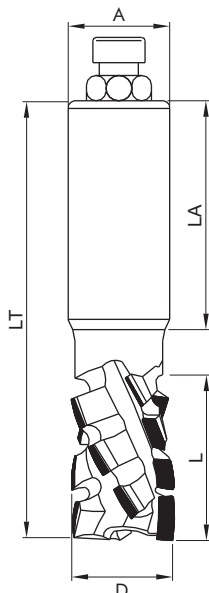

D	L	LT	AxLA	N DIA	DX-RX	SX-LX	€
22	25	86	20x50	9	PD220259D	PD220259S	322,00
22	31	91	20x50	11	PD2203111D	PD2203111S	322,00
22	36	96	20x50	13	PD2203613D	PD2203613S	380,00
22	41	101	20x50	15	PD2204115D	PD2204115S	438,00
22	47	106	20x50	17	PD2204717D	PD2204717S	498,00
25	52	121	25x55	19	PD2505219D	PD2505219S	555,00
25	57	125	25x55	21	PD2505721D	PD2505721S	614,00
25	63	131	25x55	23	PD2506323D	PD2506323S	672,00
25	68	135	25x55	25	PD2506825D	PD2506825S	730,00

P  
U

6  
6  
6

GDA  
High-tech tools

## PUNTE IN DIAMANTE PER PANTOGRAFO



**DIAMANTE/PCD**  
**H=4,5 Z=2+1**

**GB** Diamond router bit

**F** Meche a defoncer avec diamant

**E** Broca para fresadora con diamante

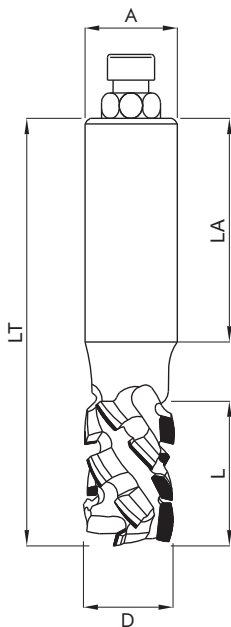

D	L	LT	AxLA	N DIA	DX-RX	SX-LX	€
22	25	86	20x50	11	PD2202511D	PD2202511S	464,00
22	31	91	20x50	13	PD2203113D	PD2203113S	549,00
22	36	96	20x50	15	PD2203615D	PD2203615S	634,00
22	41	101	20x50	17	PD2204117D	PD2204117S	718,00
25	47	116	25x55	19	PD2504719D	PD2504719S	802,00
25	52	121	25x55	21	PD2505221D	PD2505221S	887,00
25	57	125	25x55	23	PD2505723D	PD2505723S	971,00
25	63	131	25x55	25	PD2506325D	PD2506325S	1.056,00
25	68	135	25x55	27	PD2506827D	PD2506827S	1.140,00

P  
U

6  
6  
7

GDA  
High-tech tools

## PUNTE IN DIAMANTE PER PANTOGRAFO



**DIAMANTE/PCD**  
**H=4,5 Z=3+1**

**GB** Diamond router bit

**F** Meche a defoncer avec diamant

**E** Broca para fresadora con diamante

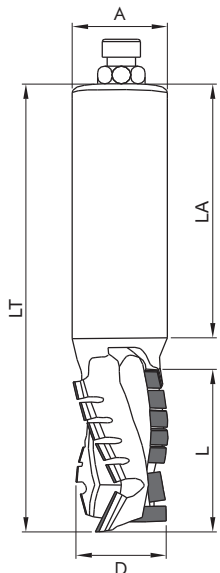

D	L	LT	AxLA	N DIA	DX-RX	SX-LX	€
20	25	88	20x50	11	PD2002511D	PD2002511S	374,00
20	30	92	20x50	14	PD2003014D	PD2003014S	438,00
22	35	97	20x50	17	PD2203517D	PD2203517S	552,00
22	40	102	20x50	20	PD2204020D	PD2204020S	650,00
25	25	100	25x55	11	PD2502511D	PD2502511S	374,00
25	30	100	25x55	14	PD2503014D	PD2503014S	438,00
25	35	105	25x55	17	PD2503517D	PD2503517S	552,00
25	40	110	25x55	20	PD2504020D	PD2504020S	650,00
25	45	115	25x55	23	PD2504523D	PD2504523S	731,00
25	50	120	25x55	27	PD2505027D	PD2505027S	764,00
25	55	125	25x55	30	PD2505530D	PD2505530S	877,00
25	62	130	25x55	33	PD2506233D	PD2506233S	975,00
25	67	135	25x55	36	PD2506736D	PD2506736S	1.040,00

P  
U

6  
6  
8



## PUNTE IN DIAMANTE PER FORI CIECHI

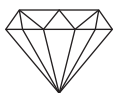

**DIAMANTE/PCD**  
**Z=2**



Diamond  
dowell drill bits



Meche a percer  
avec diamant



Broca para agujero  
ciego con diamante

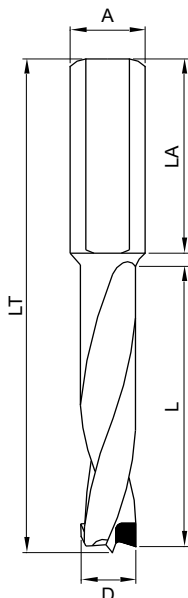

D	L	LT	AxLA	N DIA	DX-RX	SX-LX	€
5	27	57,5	10x25	2	PD050272D	PD050272S	*
5	35	70	10x30	2	PD050352D	PD050352S	*
6	27	57,5	10x25	2	PD060272D	PD060272S	*
6	35	70	10x30	2	PD060352D	PD060352S	*
8	27	57,5	10x25	2	PD080272D	PD080272S	*
8	35	70	10x30	2	PD080352D	PD080352S	*
10	27	57,5	10x25	2	PD100272D	PD100272S	*
10	35	70	10x30	2	PD100352D	PD100352S	*
12	27	57,5	10x25	2	PD120272D	PD120272S	*
12	35	70	10x30	2	PD120352D	PD120352S	*

PREZZO SECONDO QUANTITÀ RICHIESTE  
PRICE BASED ON REQUESTED QUANTITIES  
PRIX SELON QUANTITÉS REQUISES  
PRECIO SEGÚN CANTIDADES NECESARIAS

P  
U

6  
6  
9



## PUNTE IN DIAMANTE PER FORI PASSANTI



**DIAMANTE/PCD**  
**Z=2**



Dia trough  
bore drill bit



Meche a percer  
avec diamant



Broca para agujero  
pasante con diamante

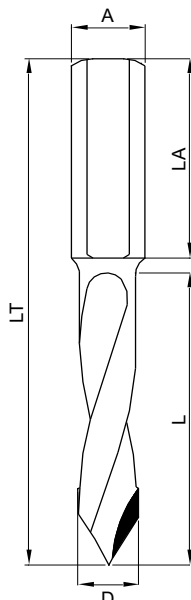

D	L	LT	AxLA	N DIA	DX-RX	SX-LX	€
5	27	57,5	10x25	2	PD050272D/1	PD050272S/1	*
5	35	70	10x30	2	PD050352D/1	PD050352S/1	*
6	27	57,5	10x25	2	PD060272D/1	PD060272S/1	*
6	35	70	10x30	2	PD060352D/1	PD060352S/1	*
8	27	57,5	10x25	2	PD080272D/1	PD080272S/1	*
8	35	70	10x30	2	PD080352D/1	PD080352S/1	*
10	27	57,5	10x25	2	PD100272D/1	PD100272S/1	*
10	35	70	10x30	2	PD100352D/1	PD100352S/1	*
12	27	57,5	10x25	2	PD120272D/1	PD120272S/1	*
12	35	70	10x30	2	PD120352D/1	PD120352S/1	*

PREZZO SECONDO QUANTITÀ RICHIESTE  
PRICE BASED ON REQUESTED QUANTITIES  
PRIX SELON QUANTITÉS REQUISES  
PRECIO SEGÚN CANTIDADES NECESARIAS



# PUNTE IN DIAMANTE PER CERNIERE



**DIAMANTE/PCD**  
**H=3 Z=2+2**



Hinge diamond boring bit



Meche a percer avec diamant



Broca para herrajes con diamante

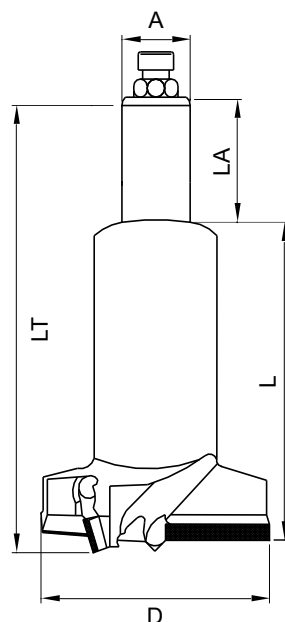

D	L	LT	AxLA	N DIA	DX-RX	SX-LX	€
14	30	57,5	10x25	4	PD140304D	PD140304S	212,00
14	42	70	10x25	4	PD140424D	PD140424S	212,00
15	30	57,5	10x25	4	PD150304D	PD150304S	212,00
15	42	70	10x25	4	PD150424D	PD150424S	212,00
16	30	57,5	10x25	4	PD160304D	PD160304S	212,00
16	42	70	10x25	4	PD160424D	PD160424S	212,00
18	30	57,5	10x25	4	PD180304D	PD180304S	212,00
18	42	70	10x25	4	PD180424D	PD180424S	212,00
20	30	57,5	10x25	4	PD200304D	PD200304S	228,00
20	42	70	10x25	4	PD200424D	PD200424S	228,00
25	30	57,5	10x25	4	PD250304D	PD250304S	244,00
25	42	70	10x25	4	PD250424D	PD250424S	244,00
26	30	57,5	10x25	4	PD260304D	PD260304S	244,00
26	42	70	10x25	4	PD260424D	PD260424S	244,00
30	30	57,5	10x25	4	PD300304D	PD300304S	278,00
30	42	70	10x25	4	PD300424D	PD300424S	278,00
35	30	57,5	10x25	4	PD350304D	PD350304S	309,00
35	42	70	10x25	4	PD350424D	PD350424S	309,00
40	30	57,5	10x25	4	PD400304D	PD400304S	358,00
40	42	70	10x25	4	PD400424D	PD400424S	358,00

FR

672

GDA  
High-tech tools

## FRESE IN DIAMANTE AD ELICA PER RETTIFICARE

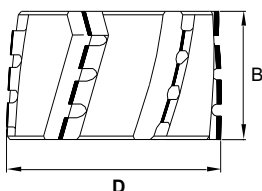
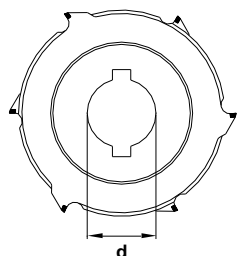
DIAMANTE/PCD  
H=2,5 Z=3+3Jointing cutter  
in diamond  
with helicoidalFraise à calibrer  
à hélice  
en diamantAntiastilla  
de hélice  
en diamante

D	B	d	N. DIA	DIA H=2,5 DX-RX	DIA H=2,5 SX-LX	€
80	40	30	15	FD80403515D	FD80403515S	536,00
80	48	30	18	FD80483018D	FD80483018S	643,00
80	55	30	21	FD80553021D	FD80553021S	750,00
80	65	30	24	FD80653024D	FD80653024S	858,00
100	40	30	15	FD100403015D	FD100403015S	536,00
100	48	30	18	FD100483018D	FD100483018S	643,00
100	55	30	21	FD100553021D	FD100553021S	750,00
100	65	30	24	FD100653024D	FD100653024S	858,00
125	40	30	15	FD125403015D	FD125403015S	536,00
125	48	30	18	FD125483018D	FD125483018S	643,00
125	55	30	21	FD125553021D	FD125553021S	750,00
125	65	30	24	FD125653024D	FD125653024S	858,00

FR

673

GDA  
High-tech tools

## FRESE IN DIAMANTE AD ELICA PER RETTIFICARE

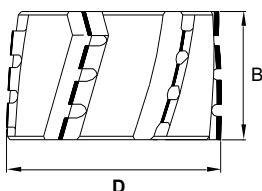
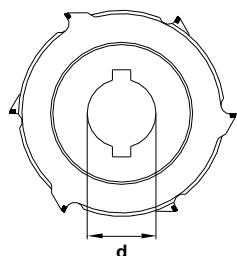
DIAMANTE/PCD  
H=4,5 Z=3+3Jointing cutter  
in diamond  
with helicoidalFraise à calibrer  
à hélice  
en diamantAntiastilla  
de hélice  
en diamante

D	B	d	N. DIA	DIA H=4,5 DX-RX	DIA H=4,5 SX-LX	€
80	40	30	15	FD80403515D/1	FD80403515S/1	682,00
80	48	30	18	FD80483018D/1	FD80483018S/1	819,00
80	55	30	21	FD80553021D/1	FD80553021S/1	955,00
80	65	30	24	FD80653024D/1	FD80653024S/1	1.092,00
100	40	30	15	FD100403015D/1	FD100403015S/1	682,00
100	48	30	18	FD100483018D/1	FD100483018S/1	819,00
100	55	30	21	FD100553021D/1	FD100553021S/1	955,00
100	65	30	24	FD100653024D/1	FD100653024S/1	1.092,00
125	40	30	15	FD125403015D/1	FD125403015S/1	682,00
125	48	30	18	FD125483018D/1	FD125483018S/1	819,00
125	55	30	21	FD125553021D/1	FD125553021S/1	955,00
125	65	30	24	FD125653024D/1	FD125653024S/1	1.092,00

## FRESE IN DIAMANTE REGOLABILI PER RETTIFICARE

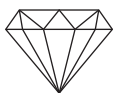

**DIAMANTE/PCD**  
**H=5**



Adjustable  
jointing cutters  
in diamond



Fraise réglable  
en diamant  
pour rectifier



Antiastillas ajustable  
en diamante  
por rectificar

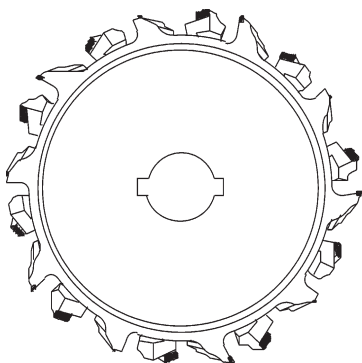

Fresa in diamante PCD per rettificare, composta da due elementi regolabili tramite spessori, adatta per lavorazioni di pannelli truciolari, nobilitati, rivestiti, laminati, impiallacciati, M.D.F., utilizzabile su macchine squadratrici. Ottima finitura, bassa rumorosità.

Adjustable jointing cutter in diamond PCD, made in two pieces adjustable by spacer rings, suitable for working on chipboard panels, coated, laminated, veneered, M.D.F., it can be used on squaring and edgbanding machines. Excellent finishing, low noisiness.

Fraise en diamant PCD pour rectifier, composée de deux pièces réglables à travers des cales, indiquée pour les travaux des panneaux de copeaux, revêtus, recouverts, laminés, plaqués et pour les panneaux de fibres à densité moyenne (ou M.D.F.), utilisable sur des machines pour l'équarrissage. Finition excellente, bruit faible.

Antiastilla extensible en diamante PCD, compuesta de dos cuerpos regulables por medio de anillos, adecuado para trabajar en paneles de aglomerados revestidos, laminados, chapados, D.M., utilizable en máquinas para escuadrar y chapar. Óptimo acabado, baja rumorosidad.

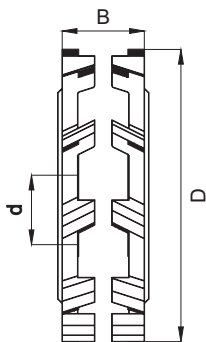

D	B	d	N. DIA	COD	€
80	20-38	30	6+6	FD8020383012	984,00
80	25-48	30	6+6	FD8025483012	1168,00
80	30-58	30	6+6	FD8030583012	1475,00
100	20-38	30	6+6	FD10020383012	984,00
100	25-48	30	6+6	FD10025483012	1168,00
100	30-58	30	6+6	FD10030583012	1475,00
125	20-38	30	6+6	FD12520383012	984,00
125	25-48	30	6+6	FD12525483012	1168,00
125	30-58	30	6+6	FD12530583012	1475,00
180	20-38	30	10+10	FD18020383020	1640,00
180	20-38	30	12+12	FD18020383024	1968,00
180	25-48	30	10+10	FD18025483020	2048,00
180	25-48	30	12+12	FD18025483024	2458,00
200	20-38	30	10+10	FD20020383020	1640,00
200	20-38	30	12+12	FD20020383024	1968,00
200	25-48	30	10+10	FD20025483020	2048,00
200	25-48	30	12+12	FD20025483024	2458,00

### Punte per mortasatrice

Slot mortise bits

Meches a mortaiser

Brocas a taladrar y escoplear

#### PU 202

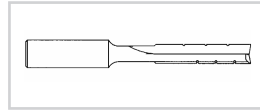

118

#### PU 204

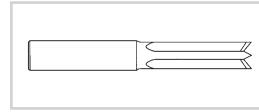

119

### Punte levanoi

Centre bits with cylindrical head

Meches a tete cylindrique

Brocas con cabeza cilindrica

#### PU 228

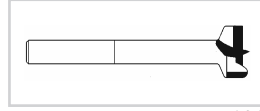

120

#### PU 230

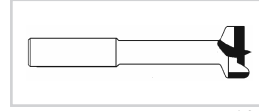

121

### Punte per forare

HW jobber drill bits

HW monobloc meches a percer

Brocas HW integral

#### PU 268

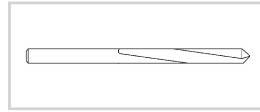

122

#### PU 270

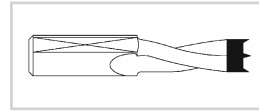

122

#### PU 272

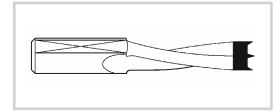

123

#### PU 284

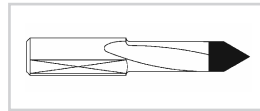

123

#### PU 286

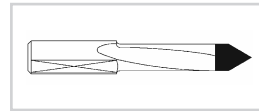

124

#### PU 290

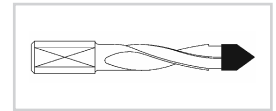

124

### Svasatori

HW countersinks

HW fraisors

HW avellanadores

#### PU 300

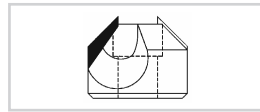

125

#### PU 302

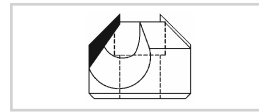

125

### Punte con svasatori per forare

Jobber drill bits with countersinks

Monobloc meches a percer avec fraisors

Brocas integrales con avellanadores

#### PU 304

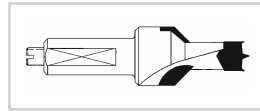

126

#### PU 310

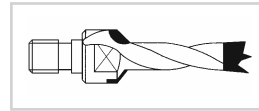

127

#### PU 312

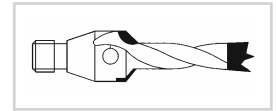

128

#### PU 314

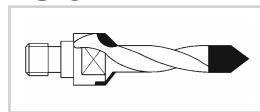

129

#### PU 316

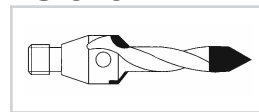

130

### Punte per cerniere

Hinge boring bits

Meches a percer

Brocs para herrajes

#### PU 342

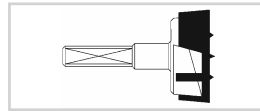

131

#### PU 344

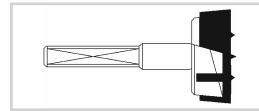

131

### Punte in HM integrale

Complete HW bits

Meches in HW intégral

Brocas de HW integral

#### PU 350

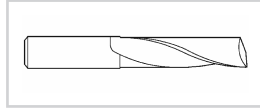

132

#### PU 352

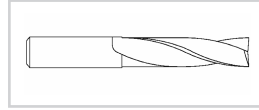

133

#### PU 354

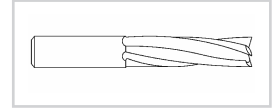

134

#### PU 358

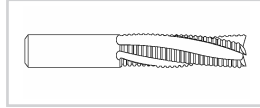

134

### Mandrini e bussole

Spindles and bushes

Brochet et douilles

Mandrillos y brújulas

#### PU 380

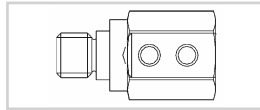

135

#### PU 382

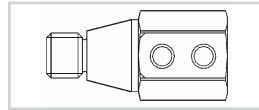

135

#### PU 384

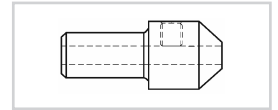

136

#### PU 386

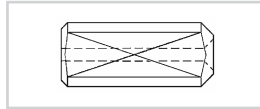

136

## SENSO DI ROTAZIONE DELLE PUNTE

HOW TO SPECIFY THE DIRECTION OF DRILLS ROTATION

CARACTERISTIQUES POUR LA DETERMINATION DU SENS DE ROTATION DES MECHEs

INDICACIONES PARA LA DETERMINACIÓN DEL SENTIDO DE GIRO



RIGHT-HAND ROTATION  
ROTATION A DROITE  
GIRO A DERECHA

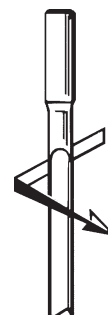
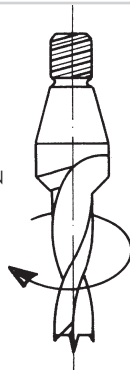

LEFT-HAND ROTATION  
ROTATION A GAUCHE  
GIRO A IZQUIERDA



## DATI TECNICI FRESE E TESTE

UTENSILI PER AVANZAMENTO MANUALE  
MANUAL FEED MOTION TOOLS  
OUTILs POUR AVANCEMENT MANUELLE  
HERRAMIENTAS PARA AVANCE MANUAL

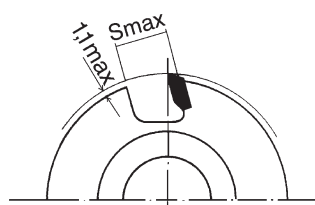

UTENSILI PER AVANZAMENTO AUTOMATICO  
MECHANICAL FEED MOTION TOOLS  
OUTILs POUR AVANCEMENT AUTOMATIQUE  
HERRAMIENTAS PARA AVANCE MECANICO

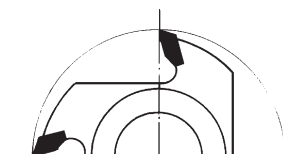

### NUMERO MASSIMO DI GIRI - MAX REVOLUTION NUMBER

Ø	UTENSILI SALDOBASATI (es. FR 500)	UTENSILI CON FISSAGGIO A CUNEO (es. FR 592)	UTENSILI A FISSAGGIO MECCANICO CON SPINE DI SICUREZZA (es. FR 582)
	GIRI/MIN - RPM/MIN - TR/MIN - REV/MIN	GIRI/MIN - RPM/MIN - TR/MIN - REV/MIN	GIRI/MIN - RPM/MIN - TR/MIN - REV/MIN
80	16.000	—	16.000
100	12.000	—	13.000
120	10.000	9.000	11.000
140	9.500	8.000	9.000
150	8.500	8.000	8.500
160	8.000	7.000	8.000

ROTAZIONE DESTRA - ANTIORARIA

RIGHT-HAND ROTATION - COUNTERCLOCKWISE

ROTATION A DROITE - DANS LE SENS INVERSE DES AIGUILLES D'UNE MONTRE

GIRO A LA DERECHA - EN SENTIDO CONTRARIO A LAS AGUJAS DEL RELOS

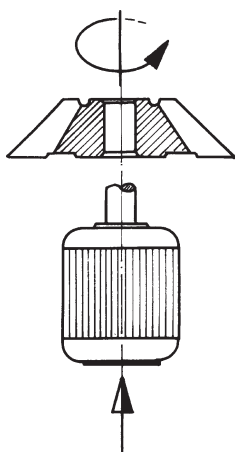

ROTAZIONE SINISTRA - ORARIA

LEFT-HAND ROTATION - CLOCKWISE

ROTATION A GAUCHE - DANS LE SENS DES AIGUILLES D'UNE MONTRE

GIRO A IZQUIERDA - EN EL SENTIDO A LAS AGUJAS DEL RELOS

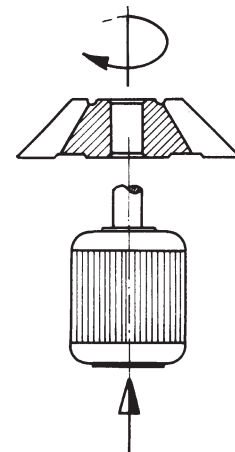

# PUNTA PER MORTASATRICE KSS 13% Cr

**GB** Slot mortise bit KSS 13% Cr

**F** Meche a mortaiser KSS 13% Cr

**E** Broca a taladrar y escoplear KSS 13% Cr

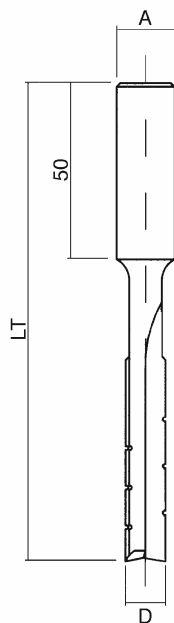

D	LT	A	Z	COD DX-RH	COD SX-LH	€
6	105	16	2	PA06055D	PA06055S	21,70
7	110	16	2	PA07060D	PA07060S	21,70
8	115	16	2	PA08065D	PA08065S	21,70
9	120	16	2	PA09070D	PA09070S	22,50
10	125	16	2	PA10075D	PA10075S	22,50
11	130	16	2	PA11080D	PA11080S	23,00
12	135	16	2	PA12085D	PA12085S	23,00
13	140	16	2	PA13090D	PA13090S	24,50
14	145	16	2	PA14095D	PA14095S	24,50
15	150	16	2	PA150100D	PA150100S	26,00
16	155	16	2	PA160105D	PA160105S	26,00
17	160	16	2	PA170110D	PA170110S	31,00
18	165	16	2	PA180115D	PA180115S	32,60
19	170	16	2	PA190120D	PA190120S	35,40
20	175	16	2	PA200125D	PA200125S	37,50
21	180	16	2	PA210130D	PA210130S	41,90
22	180	16	2	PA220130D	PA220130S	46,80
23	180	16	2	PA230130D	PA230130S	50,70
24	180	16	2	PA240130D	PA240130S	54,80
25	180	16	2	PA250130D	PA250130S	60,40





# PUNTA LEVANODI

**GB** Centre bit with cylindrical head

**F** Meche à tete cylindrique

**E** Broca con cabeza cilindrica

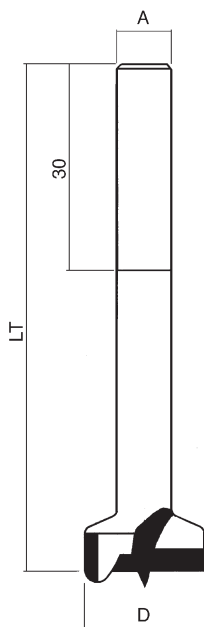

D	LT	COD DX RH	€
10	90	PP10060D	47,60
12	90	PP12060D	48,80
15	90	PP15060D	25,50
16	90	PP16060D	25,50
18	90	PP18060D	26,80
20	90	PP20060D	27,80
22	90	PP22060D	28,50
24	90	PP24060D	29,00
25	90	PP25060D	28,50
26	90	PP26060D	29,50
28	90	PP28060D	29,50
30	90	PP30060D	30,00
32	90	PP32060D	30,00
35	90	PP35060D	30,80
38	90	PP38060D	38,50
40	90	PP40060D	40,50
45	90	PP45060D	58,50
50	90	PP50060D	62,00

RIPORTI HM A=10 Z=2+V2  
 PLAQUETTE IN HW A=10 Z=2+V2  
 PLAQUETTE EN HW A=10 Z=2+V2  
 PLACA DE HW A=10 Z=2+V2

# PUNTA LEVANODI

**GB** Centre bit with cylindrical head

**F** Meche à tete cylindrique

**E** Broca con cabeza cilíndrica

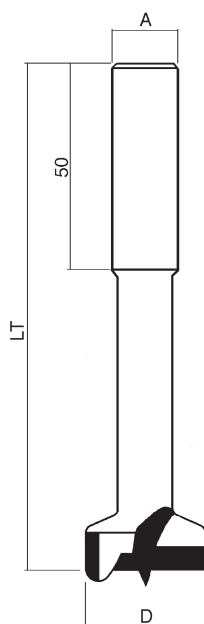

D	LT	A=13 COD DX-RH	A=16 COD DX-RH	€
10	120	PP10070D	PP10070D/1	47,60
12	120	PP12070D	PP12070D/1	48,80
14	120	PP14070D	PP14070D/1	51,50
15	120	PP15070D	PP15070D/1	52,50
16	120	PP16070D	PP16070D/1	52,50
18	120	PP18070D	PP18070D/1	54,50
20	120	PP20070D	PP20070D/1	54,50
22	125	PP22075D	PP22075D/1	56,00
24	125	PP24075D	PP24075D/1	56,00
25	125	PP25075D	PP25075D/1	56,00
26	125	PP26075D	PP26075D/1	56,00
28	130	PP28080D	PP28080D/1	58,80
30	130	PP30080D	PP30080D/1	58,80
32	130	PP32080D	PP32080D/1	61,00
34	130	PP34080D	PP34080D/1	61,00
35	130	PP35080D	PP35080D/1	61,00
36	130	PP36080D	PP36080D/1	64,50
38	130	PP38080D	PP38080D/1	67,00
40	130	PP40080D	PP40080D/1	71,00
45	130	PP45080D	PP45080D/1	80,50
50	130	PP50080D	PP50080D/1	94,00
55	140	PP55090D	PP55090D/1	115,00
60	140	PP60090D	PP60090D/1	135,00

RIPORTI HM A=13 - A=16 Z=2+V2

PLAQUETTE IN HW A=13 - A=16 Z=2+V2

PLAQUETTE EN HW A=13 - A=16 Z=2+V2

PLACA DE HW A=13 - A=16 Z=2+V2

P  
U

2  
6  
8

GDA  
High-tech tools

## PUNTA PER FORARE

**GB** HW jobber drill bits

**F** HW monobloc meches a percer

**E** Broca HW integral

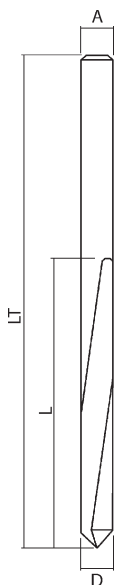

D	L	LT	COD DX-RH	COD SX-LH	€
2	16	49	PI02016D	PI02016S	12,60
2,5	27	55	PI02527D	PI02527S	13,90
3	27	55	PI03027D	PI03027S	15,90
3,5	27	55	PI03527D	PI03527S	17,90
4	27	55	PI04027D	PI04027S	19,20
5	27	55	PI05027D	PI05027S	25,80

HM INTEGRALE A=D Z=2

COMPLETE HW A=D Z=2

HW COMPLET A=D Z=2

HW COMPLETO A=D Z=2

P  
U

2  
7  
0

GDA  
High-tech tools

## PUNTA PER FORI CECCHI

**GB** Dowell drill bits

**F** Meches a percer

**E** Broca para agujero ciego

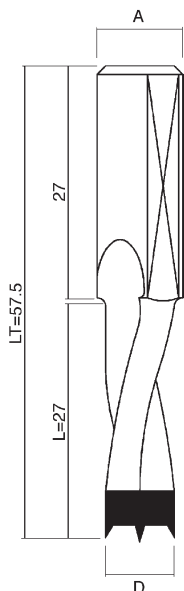

D	L	LT	COD DX-RH	COD SX-LH	€
4	27	57,5	PC04027D	PC04027S	14,40
5	27	57,5	PC05027D	PC05027S	12,40
6	27	57,5	PC06027D	PC06027S	12,40
6,35 (1/4")	27	57,5	PC06327D	PC06327S	15,60
7	27	57,5	PC07027D	PC07027S	13,80
8	27	57,5	PC08027D	PC08027S	13,30
9	27	57,5	PC09027D	PC09027S	15,30
9,53 (3/8")	27	57,5	PC09527D	PC09527S	17,00
10	27	57,5	PC10027D	PC10027S	14,70
11	27	57,5	PC11027D	PC11027S	17,00
12	27	57,5	PC12027D	PC12027S	16,70
12,7 (1/2")	27	57,5	PC12727D	PC12727S	20,80
13	27	57,5	PC13027D	PC13027S	20,80
14	27	57,5	PC14027D	PC14027S	21,70
15	27	57,5	PC15027D	PC15027S	22,80
16	27	57,5	PC16027D	PC16027S	27,00

RIPORTI HM A=10+GRANO - INC. NEG. - PTFE Z=2

PLAQUETTE IN HW A=10+DOWEL - NEGATIVE INCLINATION - PTFE Z=2

PLAQUETTE EN HW A=10+GRAIN - INCLINAISON NEGATIVE - PTFE Z=2

PLACA DE HW A=10+GRANO - INCLINACIÓN NEGATIVA - PTFE Z=2

P  
U

2  
7  
2

GDA  
High-tech tools

## PUNTA PER FORI CIECHI

**GB** Dowell drill bits

**F** Mechas a percer

**E** Broca para agujero ciego

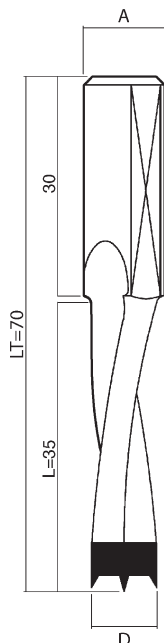

D	L	LT	COD DX-RH	COD SX-LH	€
4	35	70	PC04035D	PC04035S	15,30
5	35	70	PC05035D	PC05035S	13,30
6	35	70	PC06035D	PC06035S	13,60
6,35 (1/4")	35	70	PC06335D	PC06335S	16,20
7	35	70	PC07035D	PC07035S	14,40
8	35	70	PC08035D	PC08035S	14,10
9	35	70	PC09035D	PC09035S	15,30
9,53 (3/8")	35	70	PC09535D	PC09535S	17,30
10	35	70	PC10035D	PC10035S	15,30
11	35	70	PC11035D	PC11035S	17,60
12	35	70	PC12035D	PC12035S	17,30
12,7 (1/2")	35	70	PC12735D	PC12735S	21,70
13	35	70	PC13035D	PC13035S	21,70
14	35	70	PC14035D	PC14035S	22,20
15	35	70	PC15035D	PC15035S	23,70
16	35	70	PC16035D	PC16035S	27,70

RIPORTI HM A=10+GRANO - INC. NEG. - PTFE Z=2

PLAQUETTE IN HW A=10+DOWEL - NEGATIVE INCLINATION - PTFE Z=2

PLAQUETTE EN HW A=10+GRAIN - INCLINAISON NEGATIVE - PTFE Z=2

PLACA DE HW A=10+GRANO - INCLINACIÓN NEGATIVA - PTFE Z=2

P  
U

2  
8  
4

GDA  
High-tech tools

## PUNTA PER FORI PASSANTI

**GB** Through bore drill bits

**F** Mechas a percer

**E** Broca para agujero pasante

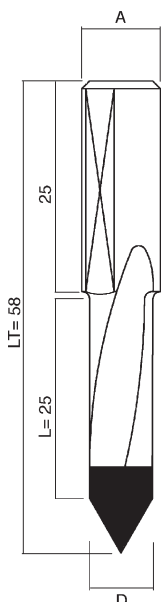

D	L	LT	COD DX-RH	COD SX-LH	€
4	25	58	PP04025D	PP04025S	17,30
5	25	58	PP05025D	PP05025S	15,90
6	25	58	PP06025D	PP06025S	15,90
6,35 (1/4")	25	58	PP06325D	PP06325S	17,00
7	25	58	PP07025D	PP07025S	17,00
8	25	58	PP08025D	PP08025S	16,70
9	25	58	PP09025D	PP09025S	17,30
10	25	58	PP10025D	PP10025S	17,90
12	25	58	PP12025D	PP12025S	21,70

RIP. HM A=10 + GRANO - PUNTA 60° - PTFE Z=2

PLAQUETTE IN HW A=10+DOWEL - DRILL 60° - PTFE Z=2

PLAQUETTE EN HW A=10+GRAIN - POINTE 60° - PTFE Z=2

PLACA DE HW A=10+GRANO - PUNTE 60° - PTFE Z=2

P  
U

2  
8  
6

GDA  
High-tech tools

## PUNTA PER FORI PASSANTI

**GB** Through bore drill bits

**F** Meches a percer

**E** Broca para agujero pasante

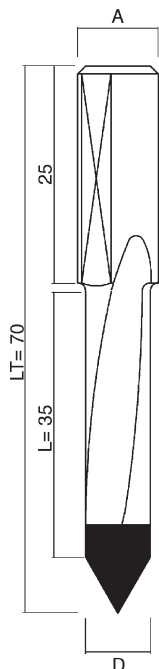

D	L	LT	COD DX-RH	COD SX-LH	€
4	35	70	PP04035D	PP04035S	18,20
5	35	70	PP05035D	PP05035S	16,80
6	35	70	PP06035D	PP06035S	17,00
6,35 (1/4")	35	70	PP06335D	PP06335S	18,50
7	35	70	PP07035D	PP07035S	18,50
8	35	70	PP08035D	PP08035S	17,90
9	35	70	PP09035D	PP09035S	19,60
10	35	70	PP10035D	PP10035S	19,60
11	35	70	PP11035D	PP11035S	23,70
12	35	70	PP12035D	PP12035S	23,70

RIP. HM A=10 + GRANO - PUNTA 60° - PTFE Z=2

PLAQUETTE IN HW A=10+DOWEL - DRILL 60° - PTFE Z=2

PLAQUETTE EN HW A=10+GRAIN - POINTE 60° - PTFE Z=2

PLACA DE HW A=10+GRANO - PUNTE 60° - PTFE Z=2

P  
U

2  
9  
0

GDA  
High-tech tools

## PUNTA PER FORI PASSANTI

**GB** Through bore drill bits

**F** Meches a percer

**E** Broca para agujero pasante

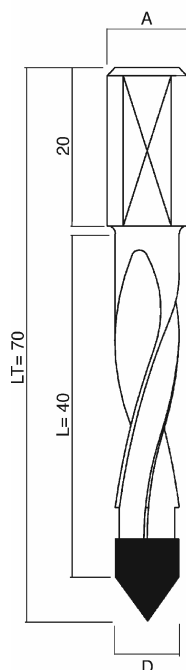

D	L	LT	COD DX-RH	COD SX-LH	€
5	40	70	PP05040D	PP05040S	16,80
6	40	70	PP06040D	PP06040S	17,00
6,35 (1/4")	40	70	PP06340D	PP06340S	18,50
7	40	70	PP07040D	PP07040S	18,50
8	40	70	PP08040D	PP08040S	17,90
9	40	70	PP09040D	PP09040S	20,00
10	40	70	PP10040D	PP10040S	19,60
11	40	70	PP11040D	PP11040S	26,00
12	40	70	PP12040D	PP12040S	22,50

RIP. HM A=10+GRANO - PUNTA 60° - PTFE Z=2/4 ELICHE

PLAQUETTE IN HW A=10+DOWEL - DRILL 60° - PTFE Z=2/4 SCREWS

PLAQUETTE EN HW A=10+GRAIN - POINTE 60° - PTFE Z=2/4 HÉLICES

PLACA DE HW A=10+GRANO - PUNTE 60° - PTFE Z=2/4 HÉLICES

P  
U

## SVASATORE PER PUNTA componibile

**GB** HW countersink for drill bit

**F** HW fraisors

**E** HW avellanador

3  
0  
0

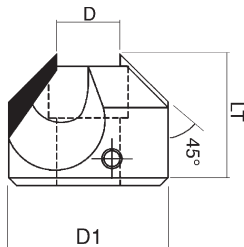

D	D1	LT	COD DX-RH	COD SX-LH	€
4	14	12	PS04012D	PS04012S	14,80
5	14	12	PS05012D	PS05012S	14,80
6	16	14	PS06014D	PS06014S	14,80
6,35 (1/4")	16	14	PS06314D	PS06314S	14,80
7	16	14	PS07014D	PS07014S	14,80
8	16	16	PS08016D	PS08016S	14,80
9	18	16	PS09016D	PS09016S	15,60
9,53 (3/8")	20	16	PS09516D	PS09516S	15,60
10	20	18	PS10018D	PS10018S	15,60
11	20	18	PS11018D	PS11018S	15,60
12	20	18	PS12018D	PS12018S	15,60

PER PUNTE / FOR BITS / POUR MECHEs / PARA BROCAS  
PU 290

RIPORTI HM Z=2  
PLAQUETTE IN HW Z=2  
PLAQUETTE EN HW Z=2  
PLACA DE HW Z=2

GDA  
High-Tech Tools

P  
U

## SVASATORE PER PUNTA componibile

**GB** HW countersink for drill bit

**F** HW fraisors

**E** HW avellanador

3  
0  
2

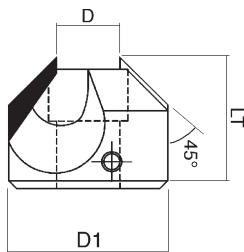

D	D1	LT	COD DX-RH	COD SX-LH	€
4-10	20	15	PS04015D	PS04015S	18,50
11-12	22	16	PS11016D	PS11016S	18,50

PER PUNTE / FOR BITS / POUR MECHEs / PARA BROCAS  
PU 270-272-284-286

RIPORTI HM Z=2  
PLAQUETTE IN HW Z=2  
PLAQUETTE EN HW Z=2  
PLACA DE HW Z=2

GDA  
High-Tech Tools

# PUNTA CON SVASATORI PER FORI CIECHI

**GB** Broaching bit with countersink

**F** Meche tourillonneuse avec fraisor

**E** Broca espigadora con avellanador

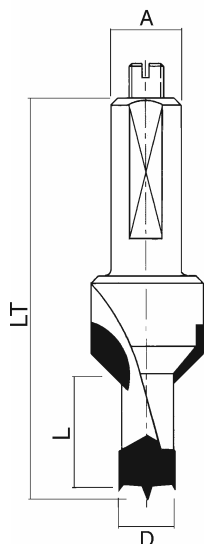

D	L	LT	COD DX-RH	COD SX-LH	€
8	12	57,5	PC08012D	PC08012S	28,00
8	15	57,5	PC08015D	PC08015S	28,00
8	20	57,5	PC08020D	PC08020S	28,00
10	12	57,5	PC10012D	PC10012S	29,00
10	15	57,5	PC10015D	PC10015S	29,00
10	20	57,5	PC10020D	PC10020S	29,00

RIPORTI HM A=10+GRANO Z=2+2

PLAQUETTE IN HW A=10+DOWEL Z=2+2

PLAQUETTE EN HW A=10+GRAIN Z=2+2

PLACA DE HW A=10+GRANO Z=2+2

# PUNTA CON SVASATORI PER FORI CIECHI

**GB** Broaching bit with countersink

**F** Meche tourillonneuse avec frasoir

**E** Broca espigadora con avellanador

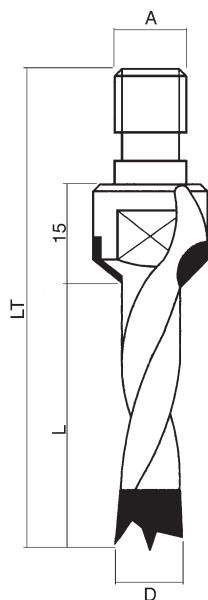

D	L	LT	COD DX RH	COD SX LH	€
5	30	61	PC05030D/1	PC05030S/1	34,20
6	30	61	PC06030D/1	PC06030S/1	34,20
7	30	61	PC07030D/1	PC07030S/1	34,20
8	30	61	PC08030D/1	PC08030S/1	34,20
9	30	61	PC09030D/1	PC09030S/1	35,40
10	30	61	PC10030D/1	PC10030S/1	35,40
5	40	71	PC05040D/1	PC05040S/1	36,60
6	40	71	PC06040D/1	PC06040S/1	36,60
7	40	71	PC07040D/1	PC07040S/1	36,60
8	40	71	PC08040D/1	PC08040S/1	36,60
9	40	71	PC09040D/1	PC09040S/1	37,80
10	40	71	PC10040D/1	PC10040S/1	37,80
5	50	81	PC05050D/1	PC05050S/1	39,00
6	50	81	PC06050D/1	PC06050S/1	39,00
7	50	81	PC07050D/1	PC07050S/1	39,00
8	50	81	PC08050D/1	PC08050S/1	39,00
9	50	81	PC09050D/1	PC09050S/1	40,20
10	50	81	PC10050D/1	PC10050S/1	40,20
11	30	61	PC11030D/1	PC11030S/1	36,60
12	30	61	PC12030D/1	PC12030S/1	36,60
13	30	61	PC13030D/1	PC13030S/1	39,80
14	30	61	PC14030D/1	PC14030S/1	39,80
15	30	61	PC15030D/1	PC15030S/1	42,70
16	30	61	PC16030D/1	PC16030S/1	45,20
11	40	71	PC11040D/1	PC11040S/1	39,00
12	40	71	PC12040D/1	PC12040S/1	39,00
13	40	71	PC13040D/1	PC13040S/1	42,20
14	40	71	PC14040D/1	PC14040S/1	42,20
15	40	71	PC15040D/1	PC15040S/1	45,20
16	40	71	PC16040D/1	PC16040S/1	47,60
11	50	81	PC11050D/1	PC11050S/1	41,50
12	50	81	PC12050D/1	PC12050S/1	41,50
13	50	81	PC13050D/1	PC13050S/1	44,60
14	50	81	PC14050D/1	PC14050S/1	44,60
15	50	81	PC15050D/1	PC15050S/1	47,60
16	50	81	PC16050D/1	PC16050S/1	50,00

RIPORTI HM A=M10x1.5 + GUIDA Ø11 Z=2+2

PLAQUETTE IN HW A=M10x15+SLIDE Ø11 Z=2+2

PLAQUETTE EN HW A=M10x15+GUIDE Ø11 Z=2+2

PLACA DE HW A=M10x15+GUÍA Ø11 Z=2+2



# PUNTA CON SVASATORI CON FORI CIECHI

**GB** Broaching bit with countersink

**F** Meche tourillonneuse avec frasoir

**E** Broca espigadora con avellanador

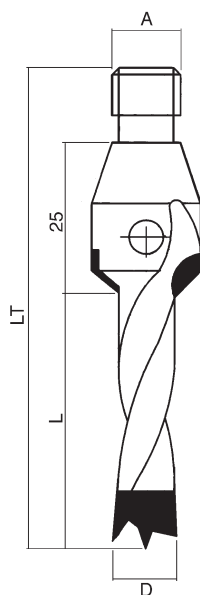

D	L	LT	COD DX RH	COD SX LH	€
5	30	66	PC05030D/2	PC05030S/2	34,20
6	30	66	PC06030D/2	PC06030S/2	34,20
7	30	66	PC07030D/2	PC07030S/2	34,20
8	30	66	PC08030D/2	PC08030S/2	34,20
9	30	66	PC09030D/2	PC09030S/2	35,40
10	30	66	PC10030D/2	PC10030S/2	35,40
5	40	76	PC05040D/2	PC05040S/2	36,60
6	40	76	PC06040D/2	PC06040S/2	36,60
7	40	76	PC07040D/2	PC07040S/2	36,60
8	40	76	PC08040D/2	PC08040S/2	36,60
9	40	76	PC09040D/2	PC09040S/2	37,80
10	40	76	PC10040D/2	PC10040S/2	37,80
5	50	86	PC05050D/2	PC05050S/2	39,00
6	50	86	PC06050D/2	PC06050S/2	39,00
7	50	86	PC07050D/2	PC07050S/2	39,00
8	50	86	PC08050D/2	PC08050S/2	39,00
9	50	86	PC09050D/2	PC09050S/2	40,20
10	50	86	PC10050D/2	PC10050S/2	40,20
11	30	66	PC11030D/2	PC11030S/2	36,60
12	30	66	PC12030D/2	PC12030S/2	36,60
13	30	66	PC13030D/2	PC13030S/2	39,80
14	30	66	PC14030D/2	PC14030S/2	39,80
15	30	66	PC15030D/2	PC15030S/2	42,70
16	30	66	PC16030D/2	PC16030S/2	45,20
11	40	76	PC11040D/2	PC11040S/2	39,00
12	40	76	PC12040D/2	PC12040S/2	39,00
13	40	76	PC13040D/2	PC13040S/2	42,20
14	40	76	PC14040D/2	PC14040S/2	42,20
15	40	76	PC15040D/2	PC15040S/2	45,20
16	40	76	PC16040D/2	PC16040S/2	47,60
11	50	86	PC11050D/2	PC11050S/2	41,50
12	50	86	PC12050D/2	PC12050S/2	41,50
13	50	86	PC13050D/2	PC13050S/2	44,60
14	50	86	PC14050D/2	PC14050S/2	44,60
15	50	86	PC15050D/2	PC15050S/2	47,60
16	50	86	PC16050D/2	PC16050S/2	50,00

RIPORTI HM A=M10x1.5 + CONO 30° Z=2+2

PLAQUETTE IN HW A=10x15+CONE 30° Z=2+2

PLAQUETTE EN HW A=10x15+CÔNE 30° Z=2+2

PLACA DE HW A=10x15+CONO 30° Z=2+2

# PUNTA CON SVASATORI PER FORI PASSANTI

**GB** Broaching bit with countersink for clearance holes

**F** Meche tourillonneuse avec outil d'évasement pour orifices passants

**E** Broca espigadora con avellanador para orificios pasantes

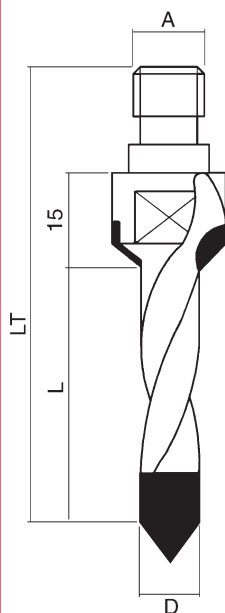

D	L	LT	COD DX RH	COD SX LH	€
5	30	61	PP05030D/1	PP05030S/1	37,80
6	30	61	PP06030D/1	PP06030S/1	37,80
7	30	61	PP07030D/1	PP07030S/1	39,00
8	30	61	PP08030D/1	PP08030S/1	39,00
5	40	71	PP05040D/1	PP05040S/1	40,30
6	40	71	PP06040D/1	PP06040S/1	40,30
7	40	71	PP07040D/1	PP07040S/1	41,50
8	40	71	PP08040D/1	PP08040S/1	41,50
5	50	81	PP05050D/1	PP05050S/1	42,80
6	50	81	PP06050D/1	PP06050S/1	42,80
7	50	81	PP07050D/1	PP07050S/1	43,90
8	50	81	PP08050D/1	PP08050S/1	43,90
9	30	61	PP09030D/1	PP09030S/1	39,10
10	30	61	PP10030D/1	PP10030S/1	39,10
11	30	61	PP11030D/1	PP11030S/1	40,30
12	30	61	PP12030D/1	PP12030S/1	40,30
9	40	71	PP09040D/1	PP09040S/1	41,60
10	40	71	PP10040D/1	PP10040S/1	41,60
11	40	71	PP11040D/1	PP11040S/1	42,80
12	40	71	PP12040D/1	PP12040S/1	42,80
9	50	81	PP09050D/1	PP09050S/1	44,00
10	50	81	PP10050D/1	PP10050S/1	44,00
11	50	81	PP11050D/1	PP11050S/1	45,20
12	50	81	PP12050D/1	PP12050S/1	45,20

RIPORTI HM A=M10x1.5 + GUIDA Ø11 - PUNTA 60° Z=2+2

PLAQUETTE IN HW A=10x15+SLIDE Ø11 - DRILL 60° Z=2+2

PLAQUETTE EN HW A=10x15+GUIDE Ø11 - POINTE 60° Z=2+2

PLACA DE HW A=10x15+GUTA Ø11 - PUNTA 60° Z=2+2

# PUNTA CON SVASATORI PER FORI PASSANTI

**GB** Broaching bit with countersink for clearance holes

**F** Meche tourillonneuse avec outil d'évasement pour orifices passants

**E** Broca espigadora con avellanador para orificios pasantes

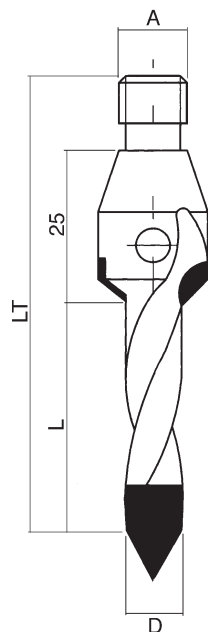

D	L	LT	COD DX RH	COD SX LH	€
5	30	66	PP05030D/2	PP05030S/2	37,80
6	30	66	PP06030D/2	PP06030S/2	37,80
7	30	66	PP07030D/2	PP07030S/2	39,00
8	30	66	PP08030D/2	PP08030S/2	39,00
5	40	76	PP05040D/2	PP05040S/2	40,30
6	40	76	PP06040D/2	PP06040S/2	40,30
7	40	76	PP07040D/2	PP07040S/2	41,50
8	40	76	PP08040D/2	PP08040S/2	41,50
5	50	86	PP05050D/2	PP05050S/2	42,80
6	50	86	PP06050D/2	PP06050S/2	42,80
7	50	86	PP07050D/2	PP07050S/2	43,90
8	50	86	PP08050D/2	PP08050S/2	43,90
9	30	66	PP09030D/2	PP09030S/2	39,10
10	30	66	PP10030D/2	PP10030S/2	39,10
11	30	66	PP11030D/2	PP11030S/2	40,30
12	30	66	PP12030D/2	PP12030S/2	40,30
9	40	76	PP09040D/2	PP09040S/2	41,60
10	40	76	PP10040D/2	PP10040S/2	41,60
11	40	76	PP11040D/2	PP11040S/2	42,80
12	40	76	PP12040D/2	PP12040S/2	42,80
9	50	86	PP09050D/2	PP09050S/2	44,00
10	50	86	PP10050D/2	PP10050S/2	44,00
11	50	86	PP11050D/2	PP11050S/2	45,20
12	50	86	PP12050D/2	PP12050S/2	45,20

RIPORTI HM A=M10x1.5 + CONO 30° Z=2+2  
 PLAQUETTE IN HW A=10x15+CONE 30° Z=2+2  
 PLAQUETTE EN HW A=10x15+CÔNE 30° Z=2+2  
 PLACA DE HW A=10x15+CONO 30° Z=2+2

P  
U

3  
4  
2

GDA  
High-tech tools

## PUNTA PER CERNIERA

**GB** Hinge boring bit

**F** Meches a percer

**E** Broca para herrajes

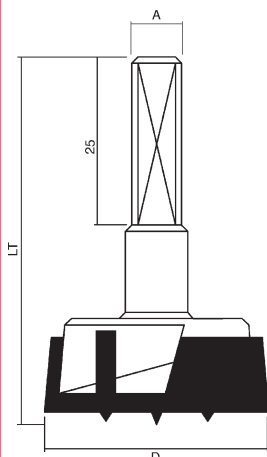

D	LT	COD DX-RH	COD SX-LH	€
15	57,5	PC15032D	PC15032S	24,50
16	57,5	PC16032D	PC16032S	25,00
18	57,5	PC18032D	PC18032S	25,00
20	57,5	PC20032D	PC20032S	25,00
22	57,5	PC22032D	PC22032S	26,00
24	57,5	PC24032D	PC24032S	26,00
25	57,5	PC25032D	PC25032S	26,00
26	57,5	PC26032D	PC26032S	26,00
28	57,5	PC28032D	PC28032S	27,00
30	57,5	PC30032D	PC30032S	27,50
32	57,5	PC32032D	PC32032S	28,00
34	57,5	PC34032D	PC34032S	29,50
35	57,5	PC35032D	PC35032S	28,50
36	57,5	PC36032D	PC36032S	31,00
38	57,5	PC38032D	PC38032S	33,50
40	57,5	PC40032D	PC40032S	35,50

RIPORTI HM A=10+GRANO Z=2+V2  
 PLAQUETTE IN HW A=10+DOWEL Z=2+V2  
 PLAQUETTE EN HW A=10+GRAIN Z=2+V2  
 PLACA DE HW A=10+GRANO Z=2+V2

P  
U

3  
4  
4

GDA  
High-tech tools

## PUNTA PER CERNIERA

**GB** Hinge boring bit

**F** Meches a percer

**E** Broca para herrajes

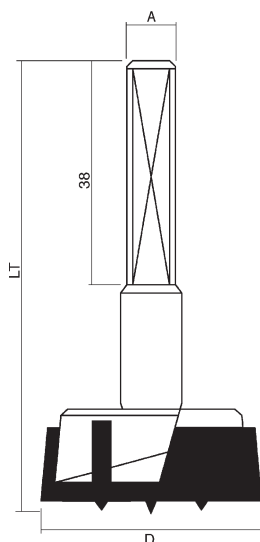

D	LT	COD DX-RH	COD SX-LH	€
15	70	PC15032D/1	PC15032S/1	27,50
16	70	PC16032D/1	PC16032S/1	27,50
20	70	PC20032D/1	PC20032S/1	29,50
25	70	PC25032D/1	PC25032S/1	31,00
26	70	PC26032D/1	PC26032S/1	31,00
30	70	PC30032D/1	PC30032S/1	32,00
35	70	PC35032D/1	PC35032S/1	33,50

RIPORTI HM A=10+GRANO Z=2+V2  
 PLAQUETTE IN HW A=10+DOWEL Z=2+V2  
 PLAQUETTE EN HW A=10+GRAIN Z=2+V2  
 PLACA DE HW A=10+GRANO Z=2+V2

# FRESA A TAGLIO ELICOIDALE

**GB** HW solid carbide spiral router bit

**F** HW meches helic pour defonceuse

**E** HW fresas helicoidales integral

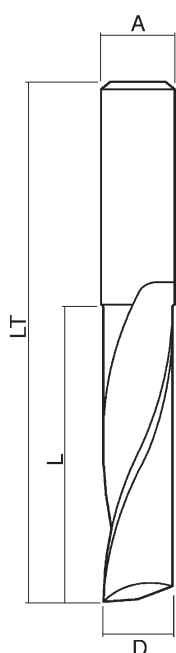
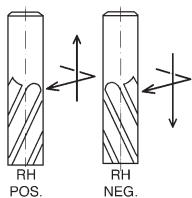

D	L	LT	RT DX POS - RH POS	RT DX NEG - RH NEG	€
3	12	40	PI03012DP	PI03012DN	15,20
4	12	50	PI04012DP	PI04012DN	18,40
5	17	50	PI05017DP	PI05017DN	21,00
6	17	60	PI06017DP	PI06017DN	27,80
6	27	60	PI06027DP	PI06027DN	29,50
8	22	80	PI08022DP	PI08022DN	40,50
8	32	80	PI08032DP	PI08032DN	44,00
10	32	80	PI10032DP	PI10032DN	56,50
10	42	100	PI10042DP	PI10042DN	63,50
12	32	80	PI12032DP	PI12032DN	90,00
12	42	100	PI12042DP	PI12042DN	101,50
12	52	100	PI12052DP	PI12052DN	106,50

HM INTEGRALE A=D Z=1 DX - POS/NEG  
 COMPLETE HW A=D Z=1 DX - POS/NEG  
 HW COMPLET A=D Z=1 DX - POS/NEG  
 HW COMPLETO A=D Z=1 DX - POS/NEG

# FRESA A TAGLIO ELICOIDALE

**GB** HW solid carbide spiral router bit

**F** HW meches helic pour defonceuse

**E** HW fresas helicoidales integral

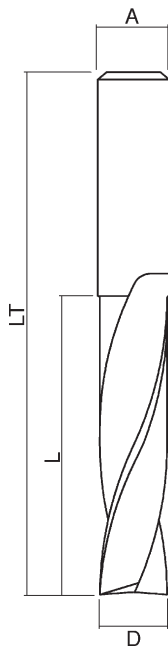
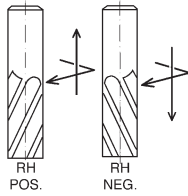

D	L	LT	RT DX POS - RH POS	RT DX NEG - RH NEG	€
3	12	50	PI03012DP/1	PI03012DN/1	15,20
4	12	50	PI04012DP/1	PI04012DN/1	18,50
5	17	50	PI05017DP/1	PI05017DN/1	21,00
6	17	60	PI06017DP/1	PI06017DN/1	27,80
6	27	60	PI06027DP/1	PI06027DN/1	29,50
8	22	80	PI08022DP/1	PI08022DN/1	40,50
8	32	80	PI08032DP/1	PI08032DN/1	44,00
10	32	80	PI10032DP/1	PI10032DN/1	56,50
10	42	100	PI10042DP/1	PI10042DN/1	63,50
12	32	80	PI12032DP/1	PI12032DN/1	90,00
12	42	100	PI12042DP/1	PI12042DN/1	101,50
12	52	100	PI12052DP/1	PI12052DN/1	106,50
14	42	100	PI14042DP/1	PI14042DN/1	119,50
14	52	100	PI14052DP/1	PI14052DN/1	134,50
16	42	100	PI16042DP/1	PI16042DN/1	158,50
16	52	100	PI16052DP/1	PI16052DN/1	164,50
16	72	120	PI16072DP/1	PI16072DN/1	193,00
18	52	100	PI18052DP/1	PI18052DN/1	212,00
18	72	120	PI18072DP/1	PI18072DN/1	253,80
18	102	150	PI180102DP/1	PI180102DN/1	318,00
20	52	100	PI20052DP/1	PI20052DN/1	227,50
20	72	120	PI20072DP/1	PI20072DN/1	301,50
20	102	150	PI200102DP/1	PI200102DN/1	348,00

HM INTEGRALE A=D Z=2 DX - POS/NEG

COMPLETE HW A=D Z=2 DX - POS/NEG

HW COMPLET A=D Z=2 DX - POS/NEG

HW COMPLETO A=D Z=2 DX - POS/NEG

P  
U

3  
5  
4



## FRESA A TAGLIO ELICOIDALE

**GB** HW solid carbide spiral router bit

**F** HW meches helic pour defonceuse

**E** HW fresas helicoidales integral

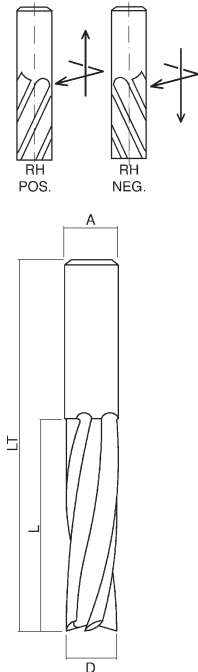

D	L	LT	RT DX POS - RH POS	RT DX NEG - RH NEG	€
8	22	80	PI08022DP/2	PI08022DN/2	45,00
8	32	80	PI08032DP/2	PI08032DN/2	48,50
10	32	80	PI10032DP/2	PI10032DN/2	62,00
10	42	100	PI10042DP/2	PI10042DN/2	70,00
12	32	80	PI12032DP/2	PI12032DN/2	99,50
12	42	100	PI12042DP/2	PI12042DN/2	111,00
12	52	100	PI12052DP/2	PI12052DN/2	117,50
14	42	100	PI14042DP/2	PI14042DN/2	131,50
14	52	100	PI14052DP/2	PI14052DN/2	147,50
16	42	100	PI16042DP/2	PI16042DN/2	174,00
16	52	100	PI16052DP/2	PI16052DN/2	180,50
16	72	120	PI16072DP/2	PI16072DN/2	212,50
18	52	100	PI18052DP/2	PI18052DN/2	234,00
18	72	120	PI18072DP/2	PI18072DN/2	279,00
18	102	150	PI180102DP/2	PI180102DN/2	350,00
20	52	100	PI20052DP/2	PI20052DN/2	250,00
20	72	120	PI20072DP/2	PI20072DN/2	332,00
20	102	150	PI200102DP/2	PI200102DN/2	383,00

HM INTEGRALE A=D Z=3 DX - POS/NEG

COMPLETE HW A=D Z=3 DX - POS/NEG

HW COMPLET A=D Z=3 DX - POS/NEG

HW COMPLETO A=D Z=3 DX - POS/NEG

P  
U

3  
5  
8



## FRESA A TAGLIO ELICOIDALE

**GB** HW solid carbide spiral router bit

**F** HW meches helic pour defonceuse

**E** HW fresas helicoidales integral

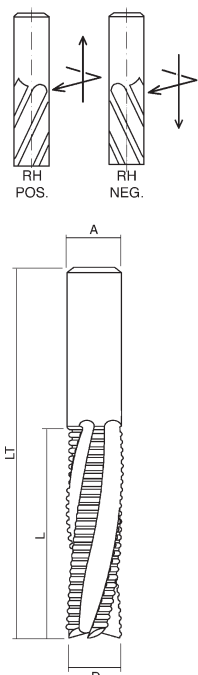

D	L	LT	RT DX POS - RH POS	RT DX NEG - RH NEG	€
8	22	80	PI08022DP/3	PI08022DN/3	56,00
8	32	80	PI08032DP/3	PI08032DN/3	60,50
10	32	80	PI10032DP/3	PI10032DN/3	77,50
10	42	100	PI10042DP/3	PI10042DN/3	87,00
12	32	80	PI12032DP/3	PI12032DN/3	124,00
12	42	100	PI12042DP/3	PI12042DN/3	139,00
12	52	100	PI12052DP/3	PI12052DN/3	146,50
14	42	100	PI14042DP/3	PI14042DN/3	164,50
14	52	100	PI14052DP/3	PI14052DN/3	184,50
16	42	100	PI16042DP/3	PI16042DN/3	217,50
16	52	100	PI16052DP/3	PI16052DN/3	256,00
16	72	120	PI16072DP/3	PI16072DN/3	265,50
18	52	100	PI18052DP/3	PI18052DN/3	291,50
18	72	120	PI18072DP/3	PI18072DN/3	349,00
18	102	150	PI180102DP/3	PI180102DN/3	437,00
20	52	100	PI20052DP/3	PI20052DN/3	313,00
20	72	120	PI20072DP/3	PI20072DN/3	415,00
20	102	150	PI200102DP/3	PI200102DN/3	478,00

HM INTEGRALE A=D Z=3 DX - POS/NEG

COMPLETE HW A=D Z=3 DX - POS/NEG

HW COMPLET A=D Z=3 DX - POS/NEG

HW COMPLETO A=D Z=3 DX - POS/NEG

## MANDRINO PER PUNTA COMPONENTE

**GB** Drill holder

**F** Mandrins pour meches a element

**E** Portabrocas

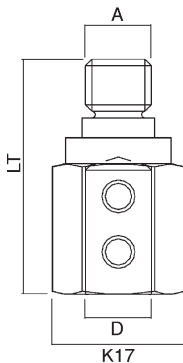

D	LT	COD DX RH	COD SX LH	€
8	40	PM08040D	PM08040S	8,00
10	40	PM10040D	PM10040S	8,00

ACCIAIO A=M10x1,5 + GUIDA Ø11  
 STEEL A=M10x1,5 + SLIDE Ø11  
 ACIER A=M10x1,5 + GUIDE Ø11  
 ACERO A=M10x1,5 + GUIA Ø11

## MANDRINO PER PUNTA COMPONENTE

**GB** Drill holder

**F** Mandrins pour meches a element

**E** Portabrocas

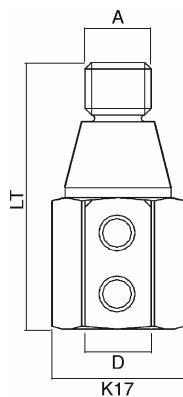

D	LT	COD DX RH	COD SX LH	€
8	46	PM08046D	PM08046S	8,00
10	46	PM10046D	PM10046S	8,00

ACCIAIO A=M10x1,5 + CONO 30°  
 STEEL A=M10x1,5 + CONE 30°  
 ACIER A=M10x1,5 + CÔNE 30°  
 ACERO A=M10x1,5 + CONO 30°



P  
U

3  
8  
4



## MANDRINO AD ATTACCO RAPIDO

**GB** Chucks with rapid shank

**F** Mandrin avec queue rapide

**E** Mandriles con mango rapido

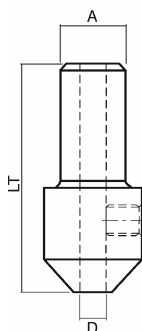

D	LT	COD DX RH + SX LH	€
2	35	PM02035	8,00
2,5	35	PM02535	8,00
3	35	PM03035	8,00
3,5	35	PM03535	8,00
4	35	PM04035	8,00
5	35	PM05035	8,00

ACCIAIO A=10x25

STEEL A=10x25

ACIER A=10x25

ACERO A=10x25

P  
U

3  
8  
6



## BUSSOLA DI RIDUZIONE

**GB** Bores reducing

**F** Manchons de reduction

**E** Casquillo de reduction

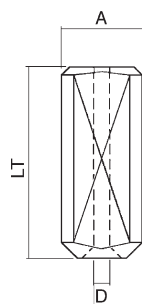

D	LT	COD DX RH + SX LH	€
2	25	PM02025	6,50
2,5	25	PM02525	6,50
3	25	PM03025	6,50
3,5	25	PM03525	6,50
4	25	PM04025	6,50
5	25	PM05025	6,50

ACCIAIO A=10

STEEL A=10

ACIER A=10

ACERO A=10

### Frese speciali a disegno

Special cutters as per drawing

Fraises spéciaux à dessin

Fresas especiales a dibujo

#### FR 500

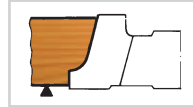

138

#### FR 502

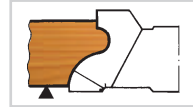

139

### Frese sagomate

Moulded cutters

Fraises façonnées

Fresas ságomadas

#### FR 504



140

#### FR 506



140

#### FR 508



141

#### FR 510



141

### Frese a smusso

Rounded cutters

Fraises biseautées

Fresas achaflanadas

#### FR 516



142

### Frese per incastri

HW grooving cutters

Fraises a rainer en HW

Fresas para ranuras en HW

#### FR 520



142

#### FR 524



143

### Frese per giunzioni

Glue joint cutters

Fraises pour abouter

Fresas para ensamblar

#### FR 527



143

### Frese per lamello

Grooving cutters for thin grooves

Fraises pour rainures

Fresas para ranuras delgadas

#### FR 528



144

#### FR 529



144



MAN

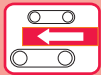

MEC

# FRESA PER PROFILI SEMPLICI IN HM

**GB** HW cutter for simple profiles

**F** Fraise pour profils simples en HW

**E** Fresa para perfiles simples en HW

**Z=2-3-4 d=Ø30-35-40-50**

D	B
100	10-80
120	10-80
140	10-100
160	10-100
180	10-100

NELL'ORDINE INDICARE IL FORO E INVIARE DISEGNO O CAMPIONE DELLA SAGOMA.

PLEASE SPECIFY IN THE ORDER THE BORE AND SEND A DRAWING OR A SAMPLE OF THE OUTLINE.

INDIQUER DANS L'ORDRE L'ALEPAGE ET ENVOYER UN DESSIN OU UN ÉCHANTILLON DU MODÈLE.

INDICAR EN EL PEDIDO L'ORIFICIO Y ENVIAR UN DIBUJO O UNA MUESTRA DEL PERFIL.

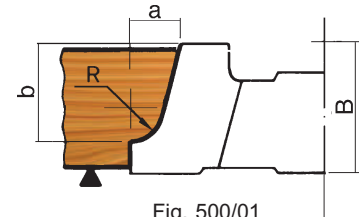

Fig. 500/01

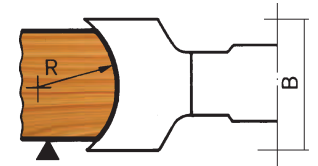

Fig. 500/02

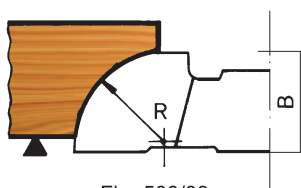

Fig. 500/03

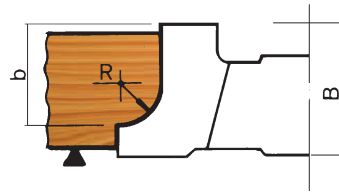

Fig. 500/04

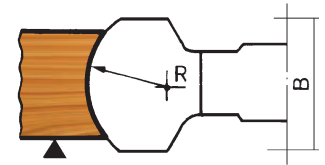

Fig. 500/05

B	Ø100 €	Ø120 €	Ø140 €	Ø160 €	Ø180 €
10	319,00	329,00	343,00	358,00	375,00
15	336,00	347,00	362,00	376,00	392,00
20	364,00	365,00	379,00	397,00	411,00
25	373,00	384,00	398,00	412,00	429,00
30	392,00	404,00	418,00	433,00	450,00
35	413,00	424,00	438,00	456,00	464,00
40	432,00	444,00	457,00	473,00	489,00
45	448,00	462,00	475,00	490,00	506,00
50	466,00	477,00	491,00	506,00	523,00
55	485,00	497,00	510,00	526,00	542,00
60	505,00	516,00	531,00	546,00	565,00
65	523,00	535,00	548,00	563,00	579,00
70	542,00	553,00	567,00	582,00	599,00
75	558,00	570,00	584,00	599,00	615,00
80	575,00	586,00	600,00	615,00	631,00
85	-	-	628,00	665,00	690,00
90	-	-	651,00	693,00	740,00
95	-	-	680,00	722,00	780,00
100	-	-	700,00	750,00	815,00

Z IN PIÙ: Z=6 AUMENTO 25%, Z=8 AUMENTO 40%

Z IN ADDITION: Z=6 INCREASE 25%, Z=8 INCREASE 40%

Z EN PLUS: Z=6 AUGMENTATION 25%, Z=8 AUGMENTATION 40%

Z MÁS: Z=6 AUMENTO 25%, Z=8 AUMENTO 40%



MAN

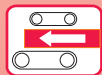

MEC

# FRESA PER PROFILI SPECIALI IN HM

**GB** HW cutter for special profiles

**F** Fraise pour profils special en HW

**E** Fresa para perfiles especiales en HW

**Z=2-3-4 d=Ø30-35-40-50**

D	B
100	10-80
120	10-80
140	10-100
160	10-100
180	10-100

NELL'ORDINE INDICARE IL FORO E INVIARE DISEGNO O CAMPIONE DELLA SAGOMA.

PLEASE SPECIFY IN THE ORDER THE BORE AND SEND A DRAWING OR A SAMPLE OF THE OUTLINE.

INDIQUER DANS L'ORDRE L'ALEPAGE ET ENVOYER UN DESSIN AN UN ÉCHANTILLON DU MODÈLE.

INDICAR EN EL PEDIDO L'ORIFICIO Y ENVIAR UN DIBUJO O UNA MUESTRA DEL PERFIL.

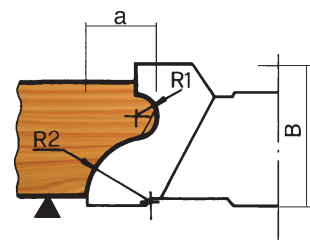

Fig. 502/01

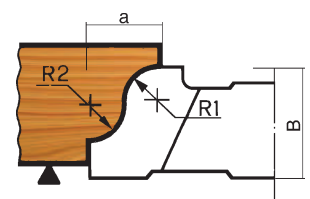

Fig. 502/02

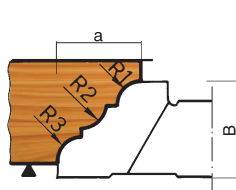

Fig. 502/03

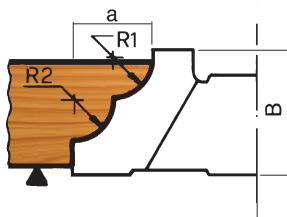

Fig. 502/04

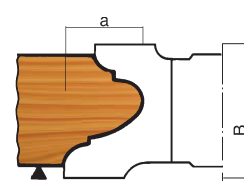

Fig. 502/05

B	Ø100 €	Ø120 €	Ø140 €	Ø160 €	Ø180 €
10	354,00	366,00	382,00	398,00	417,00
15	374,00	385,00	402,00	418,00	436,00
20	394,00	405,00	421,00	441,00	456,00
25	414,00	427,00	443,00	458,00	477,00
30	436,00	449,00	465,00	481,00	500,00
35	458,00	471,00	487,00	504,00	522,00
40	480,00	496,00	508,00	525,00	543,00
45	498,00	513,00	528,00	544,00	563,00
50	518,00	530,00	546,00	562,00	582,00
55	539,00	552,00	567,00	584,00	603,00
60	561,00	573,00	590,00	606,00	628,00
65	582,00	594,00	608,00	625,00	644,00
70	602,00	615,00	630,00	647,00	665,00
75	620,00	634,00	649,00	666,00	683,00
80	639,00	651,00	667,00	683,00	700,00
85	-	-	695,00	725,00	755,00
90	-	-	720,00	768,00	802,00
95	-	-	760,00	810,00	854,00
100	-	-	800,00	850,00	910,00

Z IN PIÙ: Z=6 AUMENTO 25%, Z=8 AUMENTO 40%

Z IN ADDITION: Z=6 INCREASE 25%, Z=8 INCREASE 40%

Z EN PLUS: Z=6 AUGMENTATION 25%, Z=8 AUGMENTATION 40%

Z MÁS: Z=6 AUMENTO 25%, Z=8 AUMENTO 40%

**F**  
**R**

## FRESA 1/4 DI TONDO CONCAVO IN HM



**GB** HW quarter round  
concave radius  
shaper cutter

**F** Fraise a rayon  
1/4 de rond concave  
en HW

**E** Fresa para radios 1/4  
de tondo concavo  
en HW

**5**  
**0**  
**4**



**MAN**

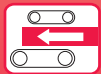

**MEC**

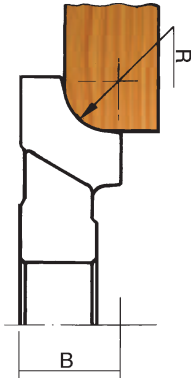

D	R	B	d	Z	COD	€
140	5	15	30	4	FS14015304	230,00
140	8	15	30	4	FS14015304/1	235,00
140	10	20	30	4	FS14020304	235,00
140	12	20	30	4	FS14020304/1	238,00
140	15	25	30	4	FS14025304	276,00
140	20	30	30	4	FS14030304	312,00
160	25	35	30	4	FS16035304	324,00
160	30	40	30	4	FS16040304	384,00

FRESE R=25-30 SOLO CON AVANZAMENTO MECCANICO  
MILLING CUTTER R=25-30 ONLY WITH MECHANICAL FEED  
CUTTER R=25-30 SEULEMENT AVEC AVANCE MÉCANIQUE  
CORTADORE R=25-30 SOLAMENTE CON ADELANTO MECÁNICA

**F**  
**R**

## FRESA 1/2 DI TONDO CONCAVO IN HM



**GB** HW half round  
concave radius  
shaper cutter

**F** Fraise a rayon  
1/2 de rond concave  
en HW

**E** Fresa para radios 1/2  
de tondo concavo  
en HW

**5**  
**0**  
**6**



**MAN**

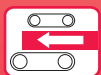

**MEC**

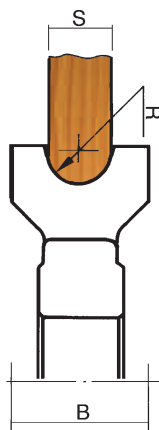

D	R	B	d	Z	COD	€
140	5	20	30	4	FS14020304A	240,00
140	6	20	30	4	FS14020304A/1	255,00
140	7,5	25	30	4	FS14025304A	260,00
140	10	30	30	4	FS14030304A	274,00
140	12,5	35	30	4	FS14035304A	300,00
140	15	40	30	4	FS14040304A	335,00
140	20	55	30	4	FS14055304A	444,00

**F**  
**R**

## FRESA 1/4 DI TONDO CONVESSO IN HM



**GB** HW quarter round convex radius shaper cutter

**F** Fraise a rayon 1/4 de rond convexe en HW

**E** Fresa para radios 1/4 de tondo convexo en HW

**5**  
**0**  
**8**



MAN

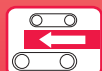

MEC

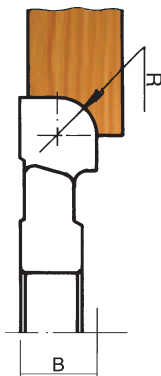

D	R	B	d	Z	COD	€
140	10	15	30	4	FS14015304B	235,00
140	15	20	30	4	FS14020304B	272,00
140	20	25	30	4	FS14025304B	312,00
140	25	30	30	4	FS14030304B	324,00
160	30	35	30	4	FS16035304B	384,00

**F**  
**R**

## FRESA 1/2 DI TONDO CONVESSO IN HM



**GB** HW half round convex radius shaper cutter

**F** Fraise a rayon 1/2 de rond convexe en HW

**E** Fresa para radios 1/2 de tondo convexo en HW

**5**  
**1**  
**0**



MAN

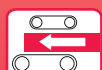

MEC

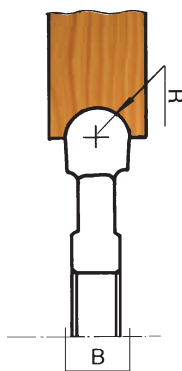

D	R	B	d	Z	COD	€
140	4	8	30	4	FS1408304C	194,00
140	5	10	30	4	FS14010304C	196,00
140	6	12	30	4	FS14012304C	200,00
140	7,5	15	30	4	FS14015304C	212,00
140	10	20	30	4	FS14020304C	220,00

**F**  
**R**

## FRESA A SMUSSO IN HM



**GB** HW bevelling cutter

**F** Fraise pour chanfrein en HW

**E** Fresa para biselar en HW

**5**  
**1**  
**6**



MAN

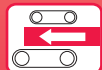

MEC

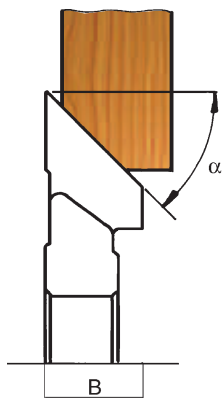

D	B	a	d	Z	COD	€
140	30	30°	30	4	FS14030304E	418,00
142	35	45°	30	4	FS14235304E	312,00
160	30	45°	30	4	FS16030304E	433,00

## FRESA A SPESSORE REGOLABILE CON INCISORI IN HM



**GB** HW adjustable thickness grooving cutter with spurs

**F** Fraise pour rainure a epaisseur réglable avec traceurs en HW

**E** Fresa para ranurar a espesor regulable con precortadores en HW

**5**  
**2**  
**0**



MAN

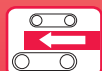

MEC

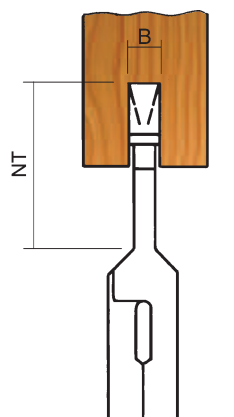

D	B	NT	d	Z	COD	€
150	4÷7,5	30	30	4+4V	FS150475308	290,00
150	8÷15,5	30	30	4+4V	FS1508155308	298,00
150	10÷19,5	30	30	4+4V	FS15010195308	312,00

F  
R

## FRESA PER INCASTRI IN HM



**GB** HW grooving cutter    **F** Fraise a rainer en HW    **E** Fresa para ranuras en HW

5  
2  
4

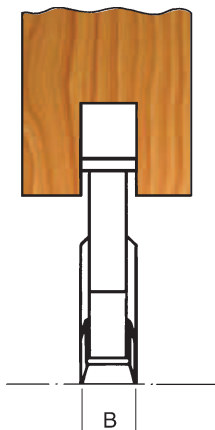

D	B	d	Z	COD	€
120	4	30	6	FS1204306F	108,00
120	5	30	6	FS1205306F	110,00
120	6	30	6	FS1206306F	112,00
120	8	30	6	FS1208306F	116,00
120	10	30	6	FS12010306F	120,00
140	4	30	6	FS1404306F	126,00
140	5	30	6	FS1405306F	130,00
140	6	30	6	FS1406306F	132,00
140	8	30	6	FS1408306F	136,00
140	10	30	6	FS14010306F	140,00



MEC



F  
R

## FRESA PER GIUNZIONI PROFONDE IN HM



**GB** HW glue joint cutter    **F** Fraise pour abouter en HW    **E** Fresa para ensamblar HW

5  
2  
7

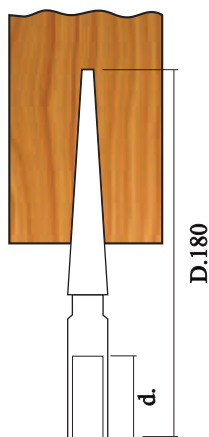

D	B	d	Z	COD	€
180	8	30	4	FS1808304	300,00

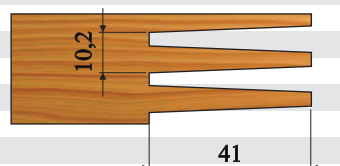
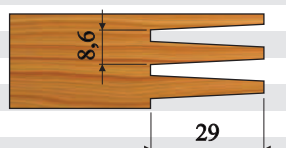
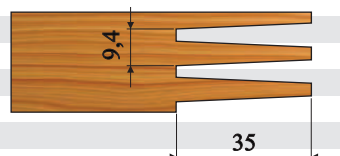
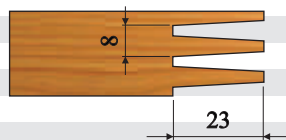

MEC





**F**  
**R**

## FRESA PER LAMELLO IN HM



**GB** HW grooving cutter  
for thin grooves

**F** Fraise pour rainures  
en HW

**E** Fresa para ranuras  
delgadas en HW

**5**  
**2**  
**8**

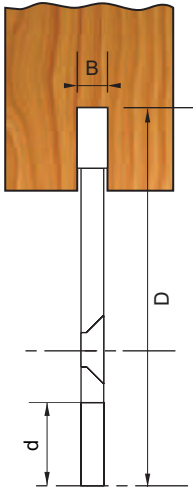

D	B	d	Z	V	COD	€
100	3,95	22	2	4	FS100395226	90,00

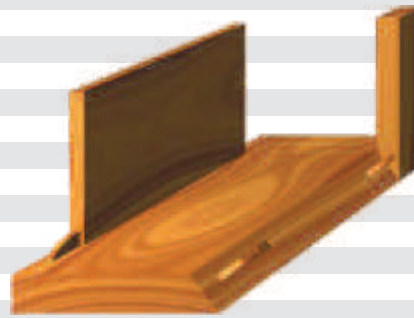

**F**  
**R**

## FRESA PER MINISPOT IN HM



**GB** HW grooving cutter  
for 'minispot'

**F** Fraise à rainier pour  
'minispot' en HW

**E** Fresa para ranuras  
'minispot' en HW

**5**  
**2**  
**9**

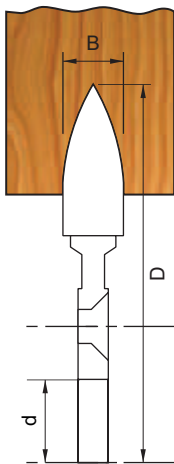

D	B	d	Z	COD	€
100	8	22	4	FS1008224	140,00



### Teste per "Finger Joint"

Jointing cutterheads type "Finger Joint"

Têtes porte-couteaux pour jonctions type « Finger Joint »

Cabezas puertas-cuchillas para uniones tipo "Finger Joint"

#### FR 532



147

#### FR 532



149

#### FR 534



151

#### FR 534

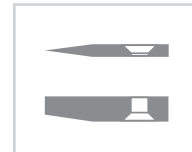

153

### Gruppi per perline e parquet

Tongue and groove cutter head sets

Porte-outils couples pour parquets

Cabezas para parquetes

#### FR 536



155

#### FR 538



156

### Teste con coltelli sagomati

Cutterheads with rounded knives

Têtes avec couteaux fagonnés

Cabezas con cuchillas sagomadas

#### FR 540



158

#### FR 542



158

#### FR 544



159

#### FR 546



159

### Teste piattabanda e ad inclinazione variabile

Ceiling heads and with changeable inclination

Têtes platebanda et avec inclinaison variable

Cabezas platabanda y con inclinación variable

#### FR 550



160

#### FR 553



161

#### FR 554



161

### Teste per incastri

Joint cutterheads

Têtes pour entailles

Cabezas por encajes

#### FR 556



162

#### FR 558



163

#### FR 560



164

#### FR 562



165

#### FR 564



166

#### FR 565



167

### Teste per giunzioni

Glue joint cutterheads

Porte-outils pour abauter

Cabezas para ensamblar

#### FR 570



168

#### FR 572



169

#### FR 573



170

### Gruppo per raggiare e smussare

Cutterhead sets for beveling - rounding

Jeu de porte-outils pour chanfreiner - arrondir

Juego de cabezales para biselar - redondear

### FR 574



171

### Gruppi per antine

Cutterhead sets for doors

Jeu de porte-outils pour portes

Juego de cabezals para puertas

### FR 576



172

### FR 578



173

### FR 580



175

### Teste per battute

Shear angle beating cutterheads

Porte-outils pour feuillures avec coupe biais

Cabezales para galces corte inclinado

### FR 582



176

### FR 586



176

### Teste per piallare con taglio elicoidale

Spiral planing cutterheads

Porte-outils helicoidal a raboter

Cabezales helicoidal para cepillar

### FR 588



177

### FR 589



178

### FR 589/A



178

### Teste per piallare a bloccaggio centrifugo

Planing cutterheads with centrifugal fixing system

Porte-outils avec bloc centrifuge

Cabezas a bloqueo centrifugo

### FR 590



179

### Teste da pialla

Planing cutterheads

Porte-outils a raboter

Cabezales para cepillar

### FR 592



180

### FR 593



181

### Teste da pialla "Hydro"

"Hydro" Planing cutterheads

Porte-outils a raboter.....

Cabezales para cepillar.....

### FR 594



182

### FR 595



183

F

R

5

3

2

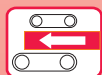

MEC

## TESTA PORTACOLTELLI PER GIUNZIONI TIPO "FINGER JOINT"

**GB** Jointing cutterhead type "finger joint"

**F** Tête porte-couteaux pour jonctions type « finger joint »

**E** Cabeza puertas-cuchillas para uniones tipo "finger joint"



Testa portacoltelli in acciaio ad alta resistenza a 4, 6 o 8 taglianti per eseguire giunzioni tipo "finger joint". Si tratta di un utensile componibile che permette di utilizzare più teste a seconda dello spessore del legno da lavorare. I coltelli sono intercambiabili e a profilo simmetrico. Le dimensioni delle giunzioni ottenibili sono : 4mm, 10/10mm, 10/11mm, 15/15mm, 15/16,5mm, 20/20mm e 20/22mm.

I coltelli sono prodotti in HS trattati con un particolare rivestimento superficiale PVD che ne aumenta la durata fino a un 100% in più e in HW (solo per le dimensioni 10/10mm e 10/11mm). Le dimensioni dei coltelli 10/11mm, 15/16,5mm e 20/22mm sono adatte per lavorazioni su macchine che utilizzano la lama ad intestare e su impianti specifici. I profili 15/15mm e 20/20mm sono adatti per macchine definite "compatte". L'utensile è adatto per eseguire giunzioni per utilizzi differenti, dalla produzione di profili lamellari in legno per serramenti ai semilavorati per arredamento. Con i profili più profondi (20/20mm e 20/22mm) si ottengono giunzioni per strutture portanti in legno lamellare (norme UNI 8922, DIN 68140 e DIN 1052), particolarmente adatte per grandi luci quali impianti sportivi, capannoni industriali, aree espositive, ponti, ecc. In fase d'ordine specificare il tipo di macchina sulla quale gli utensili saranno montati.

Finger joint cutter head body in high tensile steel with 4, 6 or 8 knives for manufacturing finger joints. The tool can be stacked based on the wood thickness to be cut. The knives are interchangeable and have a symmetrical profile. The following joints are available : 4mm, 10/10mm, 10/11mm, 15/15mm, 15/16,5mm, 20/20mm and 20/22mm.

The knives are manufactured in solid HS with special PVD surface coating for longer tooling life ( up to 100% increase). Profiles 10/11mm, 15/16,5mm and 20/22mm are specific for butting machines. The tool is suitable for use in various fields : laminar profiles, window frames, furniture, etc.

The deepest profiles (20/20mm and 20/22mm) are appropriate for glue-jointed structural wood elements for construction (DIN 68140 and DIN 1052 specifications). Profiles 15/15mm and 20/20mm are suitable to be mounted on "compact" machines. When ordering specify the type of machines on which the tool will be mounted.

Tête porte-couteaux en acier à haute résistance avec 4, 6 ou 8 couteaux pour effectuer des jonctions type « finger joint ». Il s'agit d'un outil à élément, qui permet d'utiliser plusieurs têtes selon l'épaisseur du bois à travailler. Les couteaux sont interchangeables et avec un profil symétrique. Les dimensions des jonctions réalisables sont : 4 mm, 4,5/5 mm, 10/10 mm, 15/15 mm, 15/16,5 mm, 20/20 mm et 20/22 mm.

Les couteaux sont produits en HS, traités avec une chape superficielle PVD qui augmente le durée jusqu'à 100% en plus et en HW (seulement pour les dimensions 10/10 mm et 10/11 mm). Les dimensions des couteaux 4,5/5 mm, 10/11 mm, 15/16,5 mm et 20/22 mm sont indiqués pour les travaux sur des machines qui utilisent la lame à abouter et sur des installations spécifiques. Les profils 15/15 mm et 20/20 mm sont indiqués pour des machines définies « compacte ». L'outil est indiqué pour effectuer des jonctions pour des emplois différents, de la production des profils lamellaires en bois pour bâtis aux demi-produits pour l'ameublement. Avec les profils plus profondes (20/20 mm et 20/22 mm) on obtient des jonctions pour des structures portantes en bois lamellaire (règles UNI 8922, DIN 68140 et DIN 1052), particulièrement indiqués pour des grands portées comme installations sportives, halles industrielles, aires pour expositions, ponts, etc. En phase d'ordre il faut préciser le type de machine sur laquelle les outils seront montés.

Cabeza puertas-cuchillas de acero a alta resistencia con 4, 6 o 8 cuchillas para realizar uniones tipo "finger joint". Se trata de una herramienta componible, que permite l'utilización de varias cabezas según el espesor de la madera a trabajar. Las cuchillas son intercambiables y con una perfil simétrica. Las dimensiones de las uniones realizables son: 4 mm, 4,5/5 mm, 10/10 mm, 15/15 mm, 15/16,5 mm, 20/20 mm y 20/22 mm.

Las cuchillas son producidas en HS, tratadas con un revestimiento superficial PVD que aumenta la duración hasta el 100% en más y en HW (solamente para las dimensiones 10/10 mm y 10/11 mm). Las dimensiones de las cuchillas 4,5/5 mm, 10/11 mm, 15/16,5 mm y 20/22 mm son indicados para los trabajos sobre las máquinas que utilizan la hoja para encabezar y sobre instalaciones específicas. Las perfiles 15/15 mm y 20/20 mm son indicadas para las máquinas definidas "compactas". La herramienta es indicada para realizar uniones para empleos diferentes, de la producción de las perfiles laminares de madera para edificados a los semitabajados por el moblaje. Con las perfiles más profundas (20/20 mm y 20/22 mm) obtenemos uniones para estructuras soportes de madera laminares (reglas UNI 8922, DIN 68140 y DIN 1052), particularmente indicadas para grandes transportadas como instalaciones deportivas, plazas industriales, áreas para exposiciones, puentes, etc.. En fase de pedido hay que precisar el tipo de máquina la cual las herraminetas habrán subido.

# TESTA PORTACOLTELLI PER GIUNZIONI TIPO "FINGER JOINT"

**GB** Jointing cutterhead  
type "finger joint"

**F** Tête porte-couteaux pour jonctions  
type « finger joint »

**E** Cabeza puertacuchillas para  
junciones tipo "finger joint"

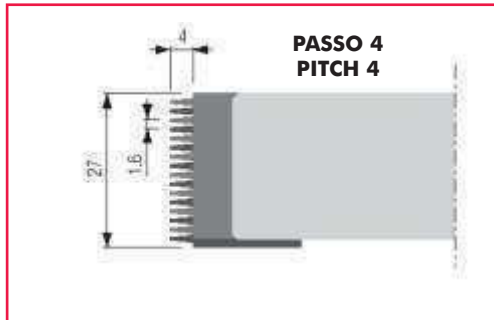

D	B	d	d <sub>MAX</sub>	Z	COD	€
160	27	40	50	4	FJ16027404	778,00
250	27	40	60	6	FJ25027406	1164,00
CORPO UTENSILE ESCLUSI COLTELLI / CUTTER EXCLUDING KNIVES						
PORTE - OUTIL SANS COUTEAUX / CABEZAL SIN CUCHILLAS						
138	25,6	40	50	4	FJ138256404	260,00
226	25,6	40	60	6	FJ226256406	388,00

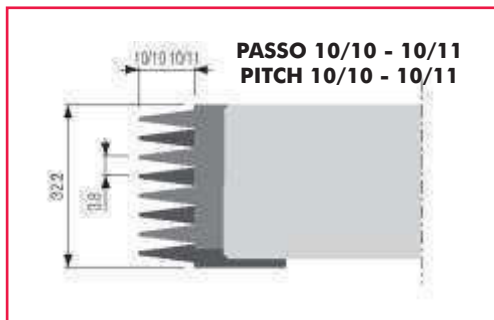

D	B	d	d <sub>MAX</sub>	Z	COD	€
160	32,2	40	50	4	FJ160322404	738,00
160	32,2	40	50	6	FJ160322406	1074,00
250	32,2	40	60	6	FJ250322406	1100,00
250	32,2	40	60	8	FJ250322408	1464,00
CORPO UTENSILE ESCLUSI COLTELLI / CUTTER EXCLUDING KNIVES						
PORTE - OUTIL SANS COUTEAUX / CABEZAL SIN CUCHILLAS						
129	30,4	40	50	4	FJ129304404	270,00
129	30,4	40	50	6	FJ129304406	372,00
216	30,4	40	60	6	FJ216304406	400,00
216	30,4	40	60	8	FJ216304408	528,00

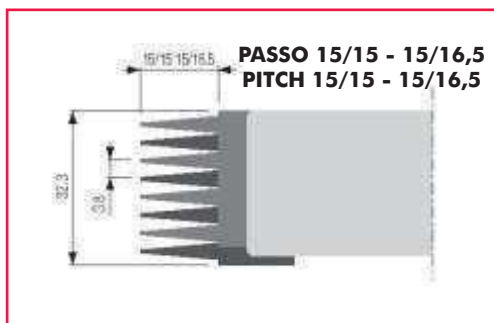

D	B	d	d <sub>MAX</sub>	Z	COD	€
170	32,3	40	50	4	FJ170323404	908,00
170	32,3	40	50	6	FJ170323406	1270,00
260	32,3	40	60	6	FJ260323406	1294,00
260	32,3	40	60	8	FJ260323408	1670,00
CORPO UTENSILE ESCLUSI COLTELLI / CUTTER EXCLUDING KNIVES						
PORTE - OUTIL SANS COUTEAUX / CABEZAL SIN CUCHILLAS						
149	30,4	40	50	4	FJ149304404	412,00
149	30,4	40	50	6	FJ149304406	528,00
235	30,4	40	60	6	FJ235304406	552,00
235	30,4	40	60	8	FJ235304408	680,00

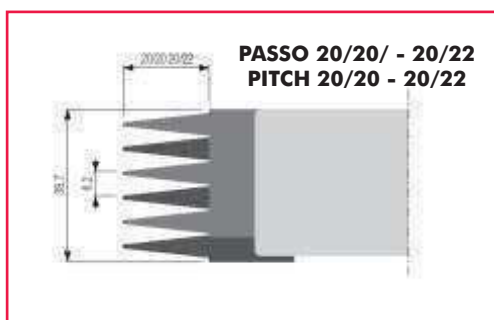

D	B	d	d <sub>MAX</sub>	Z	COD	€
180	38,7	40	50	4	FJ180387404	942,00
260	38,7	40	60	6	FJ260387406	1342,00
CORPO UTENSILE ESCLUSI COLTELLI / CUTTER EXCLUDING KNIVES						
PORTE - OUTIL SANS COUTEAUX / CABEZAL SIN CUCHILLAS						
152	37,2	40	50	4	FJ152372404	424,00
232	37,2	40	60	6	FJ232372406	566,00

# TESTA PORTACOLTELLI PER GIUNZIONI TIPO "FINGER JOINT"

**GB** Jointing cutterhead  
type "finger joint"

**F** Tête porte-couteaux pour jonctions  
type « finger joint »

**E** Cabeza puertacuchillas para  
junciones tipo "finger joint"

## COLTELLI IN HS CON SPECIALE TRATTAMENTO SUPERFICIALE PVD HS COATING KNIVES / COUTEAUX HS COATING / CUCHILLAS HS COATING

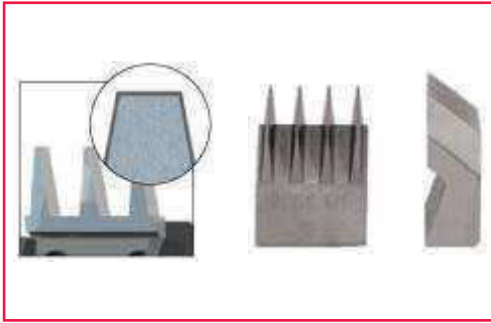

PASSO/PITCH	LxHxS	COD	€	
4	1,6	25,4x33x14	FC53241	130,00
10/10	3,8	28,4x38,5x14	FR53210101	118,00
10/11	3,8	28,4x38,5x14	FC53210111	118,00
15/15	3,8	28,4x43,5x14	FC53215151	124,00
15/16,5	3,8	28,4x43,5x14	FC532151651	124,00
20/20	6,2	32,5x48,5x14	FC53220201	130,00
20/22	6,2	32,5x48,5x14	FC53220221	130,00

## COLTELLI IN HM / HW KNIVES / COUTEAUX HW / CUCHILLAS HW



PASSO/PITCH	LxHxS	COD	€	
10/10	3,8	28,4x38,5x14	FC53210102	232,00
10/11	3,8	28,4x38,5x14	FC53210112	232,00

## SISTEMA DI LAVORAZIONE CON COLTELLI PASSO 10/11 - 15/16,5 - 20/22 MAKING SYSTEM WITH KNIVES PITCH 10/11 - 15/16,5 - 20/22 SYSTÈME DE TRAVAIL AVEC COUTEAUX PAS 10/11 - 15/16,5 - 20/22 SISTEMA DE TRABAJO CON CUCHILLAS PASO 10/11 - 15/16,5 - 20/22

1° FASE: INTESATURA CON GRUPPO TRUCIOLATORE E REGOLAZIONE DELLA LUNGHEZZA DEL DENTE (VEDI ART. IM 702 / IM 720).

2° FASE: ESECUZIONE GIUNZIONE.

1ST OPERATION: BUTTING WITH HOGGING UNIT FINGER LENGHT SETTING (SEE ART. IM 702 / IM 720).

2ND OPERATION: JOINTING OPERATION.

PREMIÈRE PHASE : ENTURE AVEC GROUP COUPEUSE À BOIS DE LA LONGUEUR DE LA DENT (VOIR ARTICLE IM 702 / IM 720).

DEUXIÈME PHASE : EXÉCUTION DE L'OPÉRATION.

PRIMERA FASE: REBAJE CON GRUPO DESMENUZADORA Y REGULACIÓN DE LA LONGITUD DEL DIENTE (VER ARTÍCULO IM 702 / IM 720).

SEGUNDA FASE: EJECUCIÓN DE LA OPERACIÓN.





# TESTA PORTACOLTELLI PER GIUNZIONI TIPO "FINGER JOINT"

**GB** Jointing cutterhead  
type "finger joint"

**F** Tête porte-couteaux pour jonctions  
type « finger joint »

**E** Cabeza puertacuchillas para  
junciones tipo "finger joint"

## TABELLA PER DETERMINARE IL NUMERO DI TESTE DA UTILIZZARE IN RELAZIONE ALLO SPESSORE LEGNO LAVORATO

CHART TO DETERMINE THE NUMBER OF CUTTERS TO BE USED DEPENDING ON THE CARVED WOOD'S THICKNESS  
TABLEAU POUR DÉTERMINER LE NUMÉRO DE TÊTES QUI DOIT ÊTRE UTILISÉ SELON L'ÉPAISSEUR DU BOIS TRAVAILLÉ  
PROSPECTO PARA DETERMINAR EL NÚMERO DE CABEZAS QUE DEBE UTILIZAR SEGÚN EL ESPESOR DE LA MADERA TRABAJADA

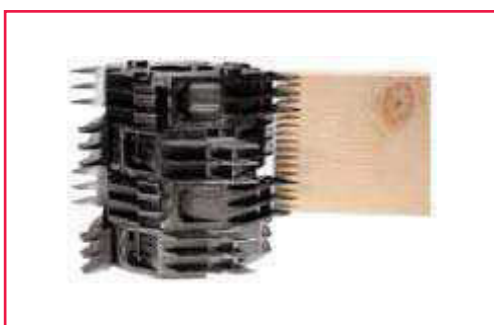
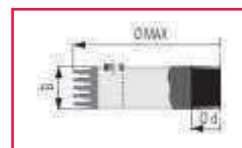
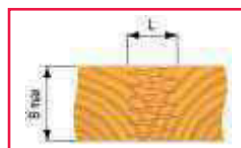

L	B	Nr. Teste Nr. Cutters Nr. Têtes Nr. Cabezas	Ø MAX	B
	25,2	1	160 (250)	27
4/4	50,8	2	160 (250)	52,6
Passo / Pitch	76,4	3	160 (250)	78,2
1,6mm	102	4	160 (250)	103,8
	127,6	5	160 (250)	129,4
	153,2	6	160 (250)	155
	29,8	1	160 (250)	32,2
	60,2	2	160 (250)	62,6
10/10 10/11	90,6	3	160 (250)	93
Passo / Pitch	121	4	160 (250)	123,4
3,8mm	151,4	5	160 (250)	153,8
	181,8	6	160 (250)	184,2
	212,2	7	160 (250)	214,6
	29,8	1	170 (260)	32,2
	60,2	2	170 (260)	62,6
	90,6	3	170 (260)	93
15/15 15/16,5	121	4	170 (260)	123,4
Passo / Pitch	151,4	5	170 (260)	153,8
3,8mm	181,8	6	170 (260)	184,2
	212,2	7	170 (260)	214,6
	242,6	8	170 (260)	245
	273	9	170 (260)	275,4
	303,4	10	170 (260)	305,8
	36,3	1	180 (260)	38,7
	73,5	2	180 (260)	75,9
	110,7	3	180 (260)	113,1
20/20 20/22	147,9	4	180 (260)	150,3
Passo / Pitch	185,1	5	180 (260)	187,5
6,2mm	222,3	6	180 (260)	224,7
	259,5	7	180 (260)	261,9
	296,7	8	180 (260)	299,1
	333,9	9	180 (260)	336,3

Per lavorazioni su macchine dotate di utensile ad innestare, in base al legno da lavorare e al dispositivo di pressatura, le giunzioni, 10/11mm, 15/16,5mm e 20/22mm permettono di ottenere giunti a dita nel rispetto delle norme vigenti.

To work on machines provided with engaging tool depending on the wood to be carved and the pressing's device, the joints, 10/11mm, 15/16,5mm and 20/22mm allow to obtain finger joints within the laws in force.

Pour des travaux sur des machines équipées d'outil à brancher, selon le bois à travailler et le dispositif à presse, les jonctions, 10/11 mm, 15/16,5 mm et 20/22 mm permettent d'obtenir des joints à doigts dans le respect des règles en vigueur.

Por elaboraciones sobre máquinas dotadas de herramienta para enchufar, según la madera a trabajar y el aparato de pressura, las junciones, 10/11mm, 15/16,5mm y 20/22mm permiten de conseguir juntos a dedos en el respeto de las normas vigentes.

F

R

5

3

4

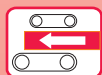

MEC

## TESTA PORTACOLTELLI PER GIUNZIONI TIPO "FINGER JOINT"

**GB** Jointing cutterhead  
type "finger joint"

**F** Tête porte-couteaux pour jonctions  
type « finger joint »

**E** Cabeza puertas-cuchillas para  
junciones tipo "finger joint"



Teste in acciaio ad alta resistenza con inserti in HM per eseguire giunzioni tipo "finger" verticali e orizzontali profilo 10/11. L'utensile garantisce un elevato rendimento sia nella lavorazione di legni teneri sia di quelli duri/esotici.

Facile sostituzione e posizionamento dei coltelli. Possibilità di riaffilatura (3,5 mm max).

High-strength steel heads with inserts in HW for horizontal and vertical "finger"-type joints, profile 10/11.

The tool guarantees high efficiency in the working of both soft and hard/exotic woods.

Easy replacement and positioning of the blades. Possibility of re-sharpening (3,5 mm max).

Têtes en acier à haute résistance avec élément en HW pour exécuter des jonctions type "finger joint" verticaux et horizontaux, profil 10/11. L'outil garantit un rendement élevé dans les travaux de bois tendres et de bois durs/exotiques aussi. Remplacement et mise en place faciles.

Cabezas de acero a alta resistencia con elemento de HW para ejecutar junciones tipo "finger joint" verticales y horizontales perfil 10/11. La herramienta garantiza un elevado rendimiento tanto en l'elaboración de maderas tiernas como de maderas duras/exóticas.



## TESTA PORTACOLTELLI PER GIUNZIONI TIPO "FINGER JOINT"

**GB** Jointing cutterhead type "finger joint"

**F** Tête porte-couteaux pour jonctions type « finger joint »

**E** Cabeza puertas-cuchillas para uniones tipo "finger joint"

D	B	d	d max	Z	N°	COD	€
160	7,6	50	70	2+2	1	FJ160765041	470,00
160	7,6	50	70	3+3	11	FJ1607650611	628,00
160	11,4	50	70	2+2+2	4	FJ1601145064	640,00
160	11,4	50	70	3+3+3	14	FJ16011450914	887,00
160	11,4	50	70	2+2	12	FJ16011450412	532,00
160	11,4	50	70	3+3	22	FJ16011450622	722,00
160	15,2	50	70	2+2+2	13	FJ16015250613	730,00
160	15,2	50	70	3+3+3	23	FJ16015250923	1014,00

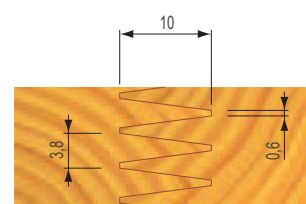
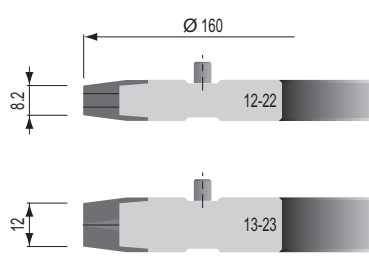
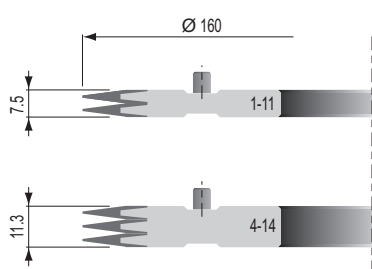

D	B	d	d max	Z	N°	COD	€
250	7,6	50	70	3+3	6	FJ250765066	692,00
250	7,6	50	70	4+4	16	FJ2507650816	850,00
250	11,4	50	70	3+3+3	9	FJ2501145099	956,00
250	11,4	50	70	4+4+4	19	FJ250114501219	1204,00
250	11,4	50	70	5+5+5	29	FJ250114501529	1350,00
250	11,4	50	70	3+3	10	FJ25011450610	836,00
250	11,4	50	70	4+4	20	FJ25011450820	1026,00
250	15,2	50	70	3+3+3	30	FJ25015250930	1120,00
250	15,2	50	70	4+4+4	40	FJ250152501240	1405,00
250	22	50	70	3+3+3	17	FJ2502250917	1120,00
250	22	50	70	3+3+3	18	FJ2502250918	1120,00
250	22	50	70	3+3+3	27	FJ2502250927	1120,00
250	22	50	70	3+3+3	28	FJ2502250928	1120,00

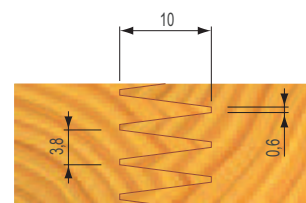
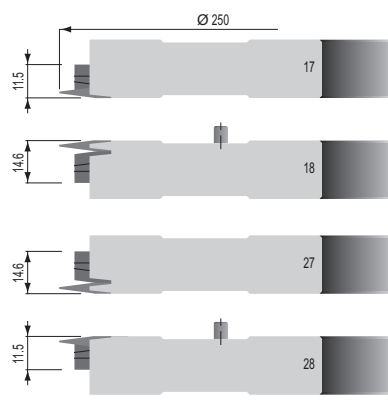
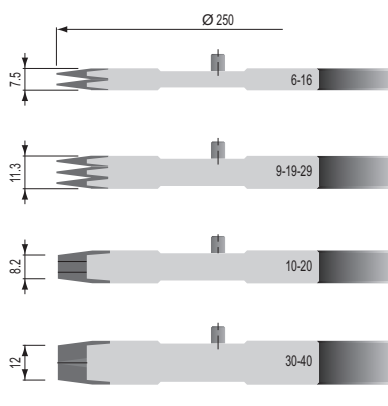

IN FASE DI ORDINE SPECIFICARE IL TIPO DI MACCHINA SULLA QUALE GLI UTENSILI SARANNO MONTATI.  
WHEN ORDERING SPECIFY THE TYPE OF MACHINE ON WHICH THE TOOLS WILL BE MOUNTED.  
EN PHASE D'ORDRE IL FAUT PRÉCISER LE TYPE DE MACHINE SUR LAQUELLE LES OUTILS SERONT MONTÉS.  
EN FASE DE PEDIDO HAY QUE PRECISAR EL TIPO DE MÁQUINA LA CUAL LA HERRAMIENTAS HABRÁN SUPIDO.











# TESTA PORTACOLTELLI PER GIUNZIONI TIPO "FINGER JOINT"

**GB** Jointing cutterhead  
type "finger joint"

**F** Tête porte-couteaux pour jonctions  
type « finger joint »

**E** Cabeza puertas-cuchillas para  
junciones tipo "finger joint"

## RICAMBI - SPARE PARTS - PIECES DE RECHANGE - RECAMBIOS

DX-RH  FC53438D	 FVM57
SX-LH  FC53438S	 FVM57
 FC53438A	 FVM513
 FC53438B	 FVM513

 HW	COD	€
38x13x3,7	FC53438D	60,50
38x13x3,7	FC53438S	60,50
38x13x7,5	FC53438A	70,00
38x13x7,5	FC53438B	70,00

	COD	€
M5x7	FVM57	5,50
M5x13	FVM513	5,50

## TABELLA PER DETERMINARE IL NUMERO DI TESTE DA UTILIZZARE IN RELAZIONE ALLO SPESSORE DEL LEGNO LAVORATO

CHART TO DETERMINE THE NUMBER OF CUTTERS TO BE USED DEPENDING ON THE CARVED WOOD'S THICKNESS  
TABLEAU POUR DÉTERMINER LE NUMÉRO DE TÊTES QUI DOIT ÊTRE UTILISÉ SELON L'ÉPAISSEUR DU BOIS TRAVAILLÉ  
PROSPECTO PARA DETERMINAR EL NÚMERO DE CABEZAS QUE DEBE UTILIZAR SEGÚN EL ESPESOR DE LA MADERA TRABAJADA

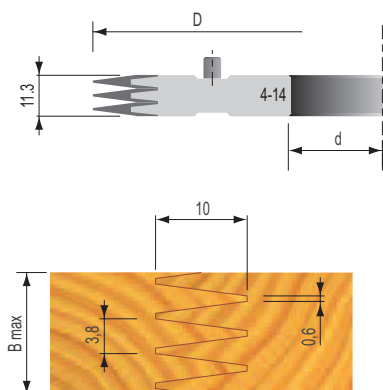

B-MAX	Nr. Teste Nr. Cutters Nr. Têtes Nr. Cabezas	B
10,8	1	11,3
22,2	2	22,7
33,6	3	34,1
45	4	45,5
56,4	5	56,9
67,8	6	68,3
79,2	7	79,7
90,6	8	91,1
102	9	102,5
113,4	10	113,9
124,8	11	125,3
136,2	12	136,7
147,6	13	148,1
159	14	159,5
170,4	15	170,9
181,8	16	182,3
193,2	17	193,7
204,6	18	205,1

**F**  
**R**

**5**  
**3**  
**4**



# TESTA PORTACOLTELLI PER GIUNZIONI TIPO "FINGER JOINT"

**GB** Jointing cutterhead type "finger joint"

**F** Tête porte-couteaux pour jonctions type « finger joint »

**E** Cabeza puertas-cuchillas para uniones tipo "finger joint"

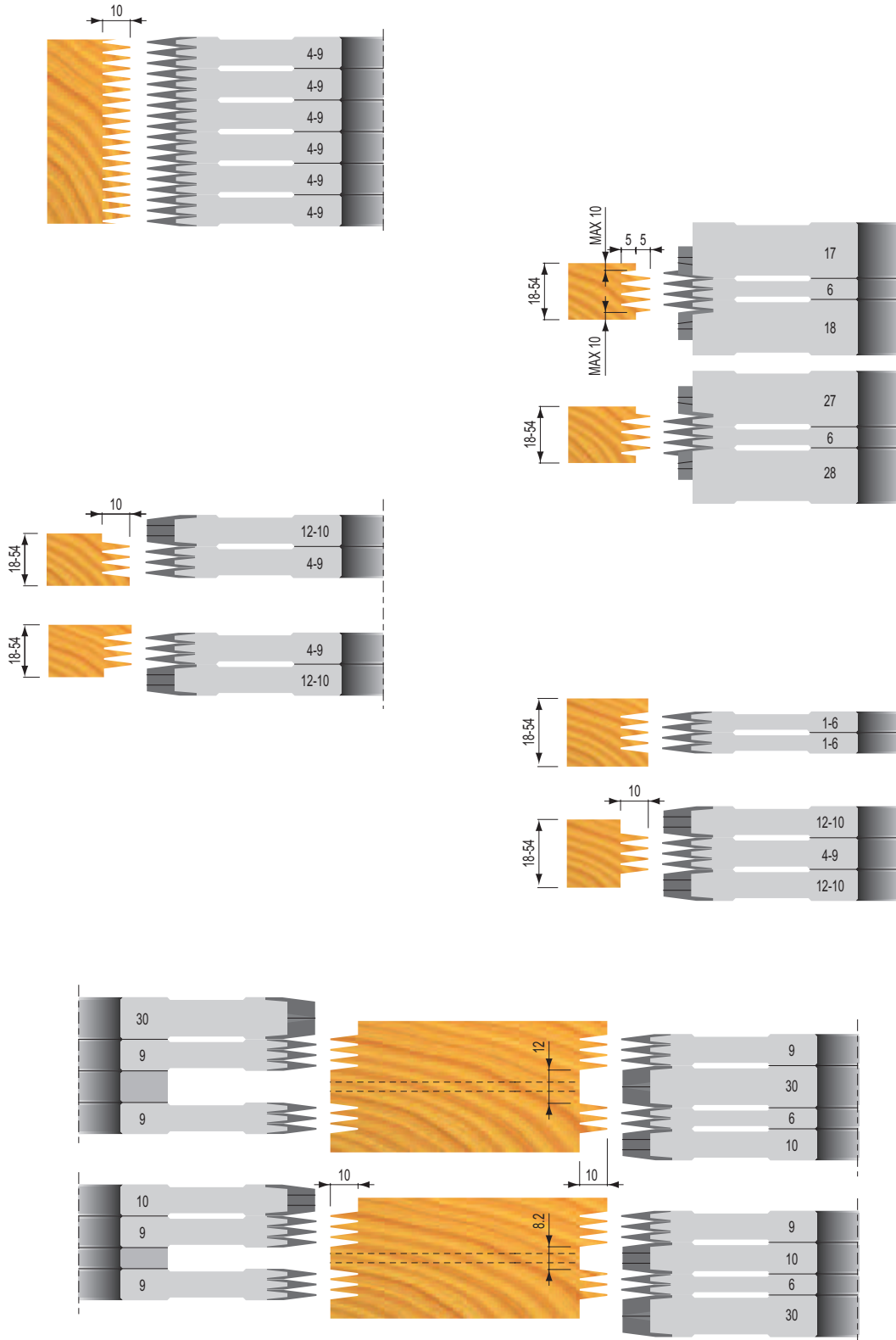



# GRUPPO TESTE PER PERLINE E PARQUET

**GB** Tongue and groove cutter head set

**F** Porte-outils couplés pour parquets

**E** Cabezales para parquets

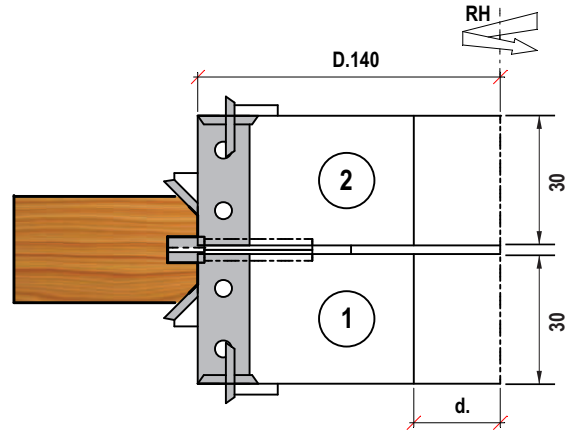
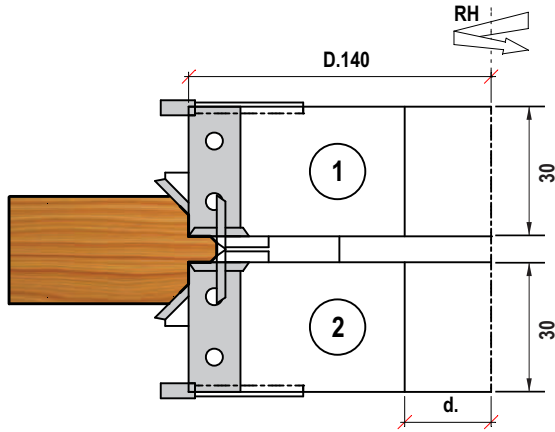

D	B	d	S	Z+V+Sp	COD	€
140	30+30	30	10-40	2+2+2	FG1403030306	646,00

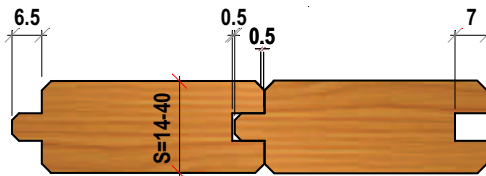
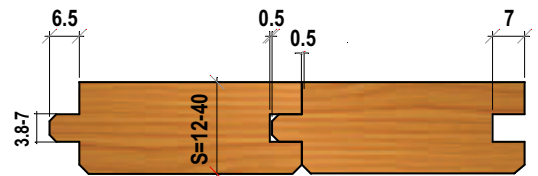
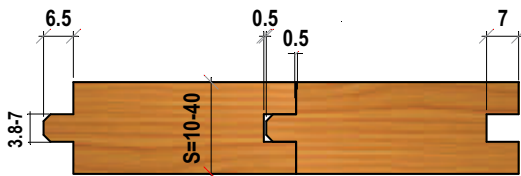

## RICAMBI - SPARE PARTS - PIECES DE RECHANGE - RECAMBIOS

**HW**

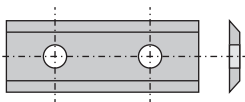

30x12x1,5  
FC612012005  
€ 2,80



14x14x2  
FC612013273  
€ 2,00

FC61333D € 34,00

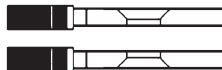

FC61333S € 34,00

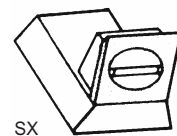

FC61352D  
€ 42,00

FC61352S  
€ 42,00



# GRUPPO TESTE PER PERLINE E PARQUET

**GB** Tongue and groove cutter head set

**F** Porte-outils couples pour parquets

**E** Cabezales para parquetes

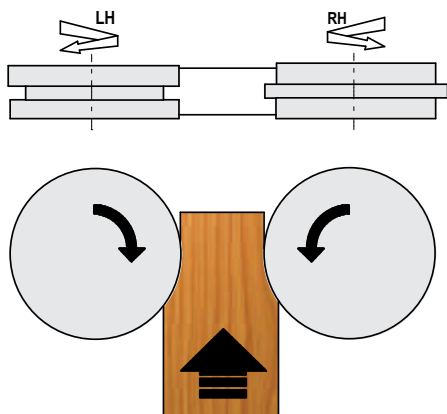

TESTA	D	B	d	Z+V+Sp
1	155	30	40	2+4+2
2	155	30	40	2+4+2
3	140	30	40	2+4+2
4	140	30	40	2+4+2
5	155	15	40	2+4+2
6	160	20	40	2+4+2

## TABELLA DEI GRUPPI / TABLES OF THE SETS TABLEAU DES GROVES / PROSPECTO DE LOS GRUPOS

PROFILO PROFILE	GRUPPO COMPOSTO DA SET OF TOOLS	S LEGNO WOOD	COD	€
A	1+2 3+4	10-40	FG15530408A	910,00
B	1+2 3+4	12-40	FG15530408B	982,00
C	1+2 3+4	14-40	FG15530408C	1020,00
D	1+5 3+6	10-30	FG16020408D	1200,00

### SERIE COMPLETA / COMPLETE SET / SÉRIE COMPLÈTE / SERIE COMPLETA

A+B+C+D	1+2+3+4+5+6	10-40	FG16020408	1556,00
---------	-------------	-------	------------	---------

## RICAMBI - SPARE PARTS - PIECES DE RECHANGE - RECAMBIOS

**HW**

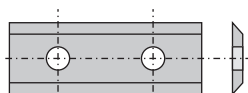

30x12x1,5  
FC612012005  
€ 2,80

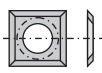

14x14x2  
FC612013273  
€ 2,00

FC61333D € 34,00

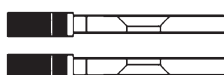

FC61333S € 34,00



FC61352D  
€ 42,00

FC61352S  
€ 42,00



# GRUPPO TESTE PER PERLINE E PARQUET

**GB** Tongue and groove cutter head set

**F** Porte-outils couples pour parquets

**E** Cabezales para parquetes

## Profili ottenibili con gruppi teste FR 538 Obtainable profiles with cutter head sets FR 538 Profils réalisables avec porte-outils couples FR 538 Perfils obtenibles con cabezales FR 538

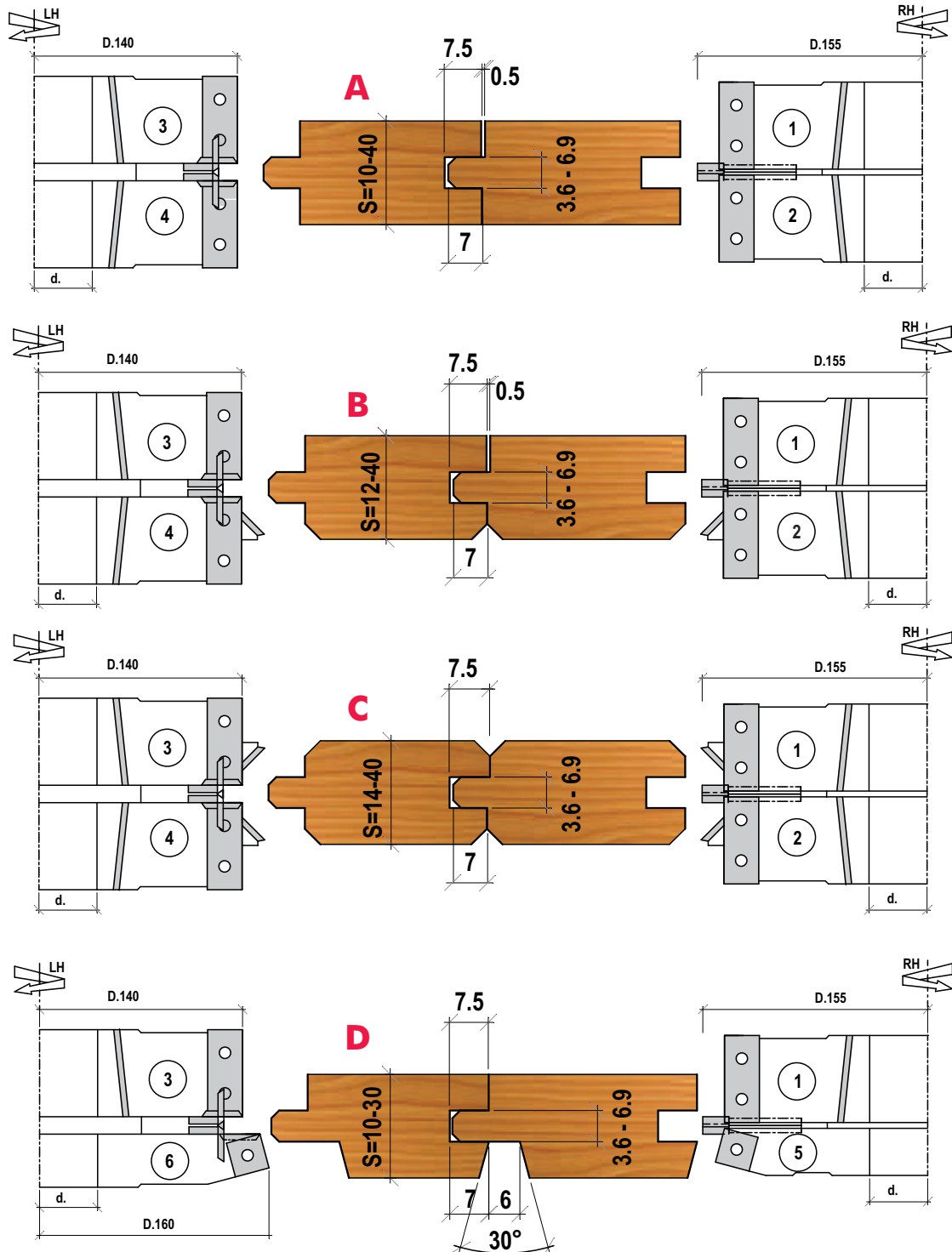

**F**  
**R**

## TESTA 1/4 DI TONDO CONCAVO

**GB** Quarter round concave radius shaper cutterhead

**F** Porte-outils a 1/4 de rond concave

**E** Cabezal de cuchillas para radios 1/4 de tondo concavo



**5**  
**4**  
**0**

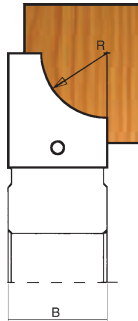

D	B	d	Z	R	COD	€
140	20	30	3	10	FB14020303	240,00
140	20	30	3	12	FB14020303/1	252,00
140	25	30	3	15	FB14025303	265,00
140	30	30	3	20	FB14030303	288,00



MAN

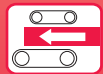

MEC

**GDA**  
High-tech tools

### RICAMBI - SPARE PARTS - PIECES DE RECHANGE - RECAMBIOS

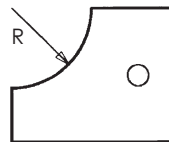

R	COD	€
10	FC61354010	25,20
12	FC61354012	25,50
15	FC61354015	28,80
20	FC61354020	31,20

**HW**

**F**  
**R**

## TESTA 1/2 DI TONDO CONCAVO

**GB** Half round concave radius shaper cutter

**F** Porte-outils a 1/2 de rond concave

**E** Cabezal de cuchillas para radios 1/2 de tondo concavo



**5**  
**4**  
**2**

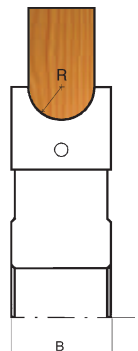

D	B	d	Z	R	COD	€
140	30	30	3	4	FB14030303A	240,00
140	30	30	3	5	FB14030303A/1	240,00
140	25	30	3	6	FB14025303A	288,00
140	25	30	3	7,5	FB14025303A/1	300,00
140	30	30	3	10	FB14030303A	312,00



MAN

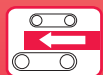

MEC

**GDA**  
High-tech tools

### RICAMBI - SPARE PARTS - PIECES DE RECHANGE - RECAMBIOS

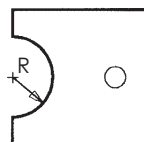

R	COD	€
4	FC6135424	18,00
5	FC6135425	18,00
6	FC6135426	26,40
7,5	FC61354275	27,00
10	FC61354210	28,80

**HW**

**F**  
**R**

## TESTA 1/4 DI TONDO CONVESSO

**GB** Quarter round convex radius shaper cutterhead

**F** Porte-outils a 1/4 de rond convexe

**E** Cabezal de cuchillas para radios 1/4 de tondo convexo



**5**  
**4**  
**4**

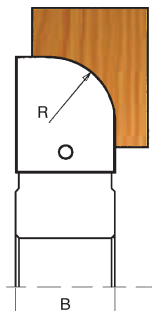

D	B	d	Z	R	COD	€
140	20	30	3	10	FB14020303B	240,00
140	20	30	3	12	FB14020303B/1	252,00
140	25	30	3	15	FB14025303B	265,00
140	30	30	3	20	FB14030303B	288,00



MAN

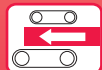

MEC

**GDA**  
High-tech tools

### RICAMBI - SPARE PARTS - PIECES DE RECHANGE - RECAMBIOS

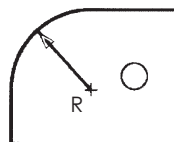

R	COD	€
10	FC61354410	25,20
12	FC61354412	25,50
15	FC61354415	28,80
20	FC61354420	31,20

**HW**

**F**  
**R**

## TESTA 1/2 DI TONDO CONVESSO

**GB** Half round convex radius shaper cutter

**F** Porte-outils a 1/2 de rond convexe

**E** Cabezal de cuchillas para radios 1/2 de tondo convexo



**5**  
**4**  
**6**

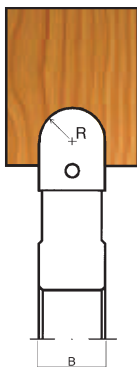

D	B	d	Z	R	COD	€
140	12	30	3	6	FB14012303C	240,00
140	15	30	3	7,5	FB14015303C	252,00
140	20	30	3	10	FB14020303C	276,00



MAN

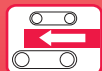

MEC

**GDA**  
High-tech tools

### RICAMBI - SPARE PARTS - PIECES DE RECHANGE - RECAMBIOS

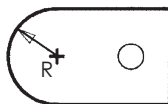

R	COD	€
6	FC6135466	26,40
7,5	FC61354675	26,40
10	FC61354610	28,70

**HW**



**F  
R**

**5  
5  
0**



# TESTA PIATTABANDA PER 12 PROFILI

**GB** Raised panel cutterhead 12 profiles

**F** Porte-outils plate-bande - 12 profils

**E** Cabezal de cuchillas plafones 12 perfils

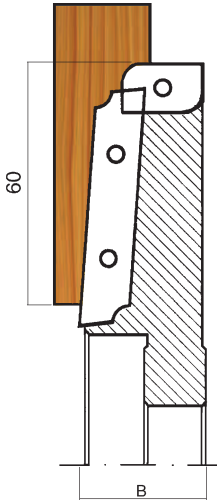

D	B	d	Z	COD	€
200	30	30	2+2	FB20030304	430,00

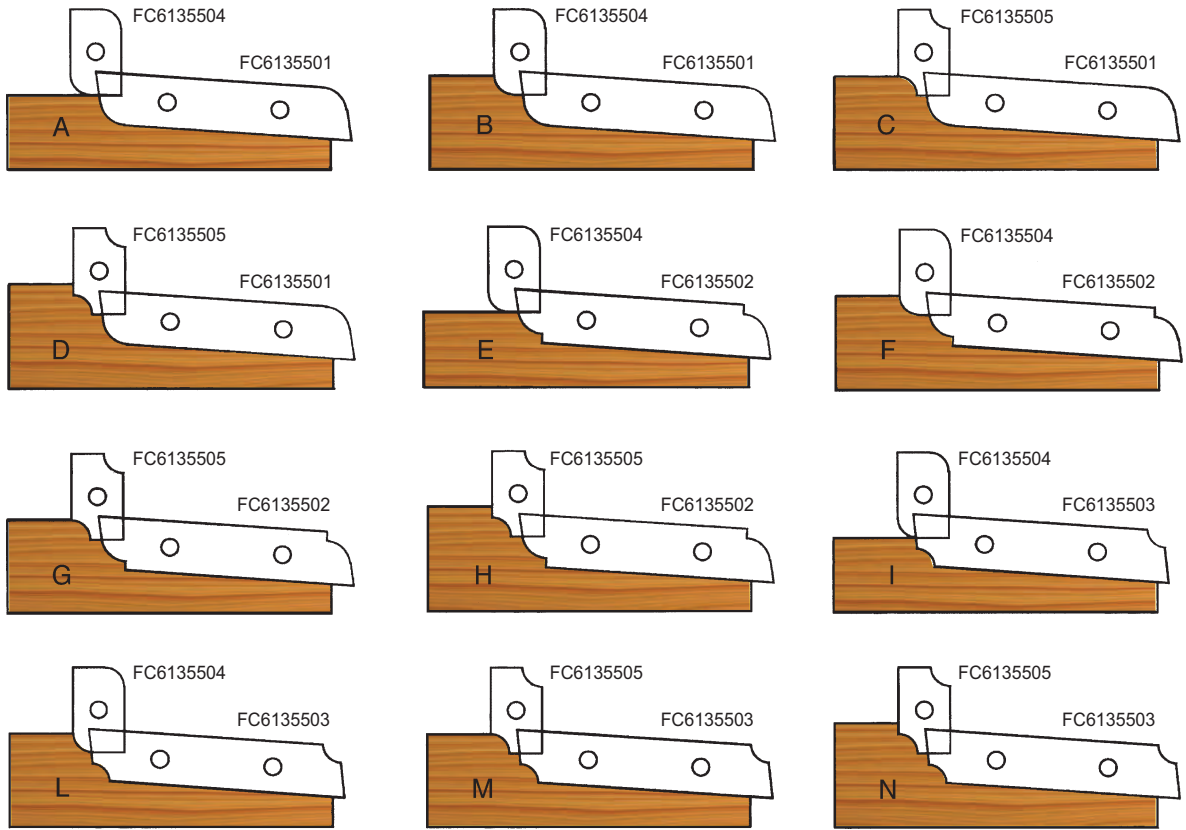

## RICAMBI - SPARE PARTS - PIECES DE RECHANGE - RECAMBIOS

**HW**

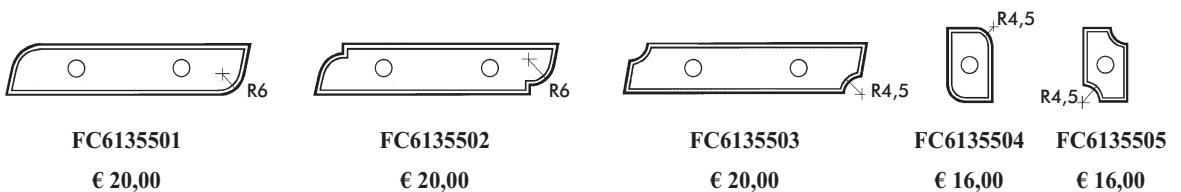

**F**  
**R**

## TESTA AD INCLINAZIONE VARIABILE REGOLAZIONE DI 5°/5°

**GB** Pivoting cutter head Adjustable 5°/5°    **F** Porte-outils à chanfreiner Inclinaire de 5°/5°    **E** Cabezal para biselar Ajustable de 5°/5°



**5**  
**5**  
**3**



MAN

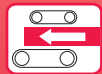

MEC



D	B	d	Z	COD	€
170	50	30	2+2V		564,00

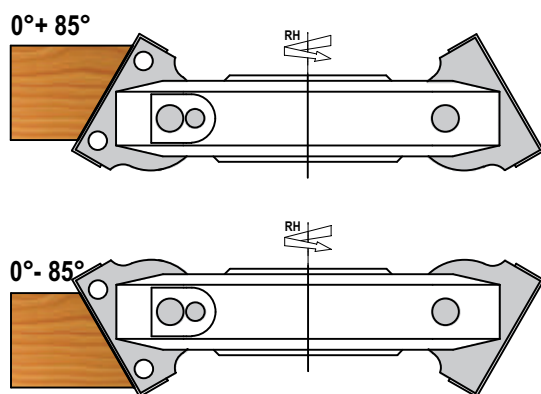

### RICAMBI - SPARE PARTS PIECES DE RECHANGE - RECAMBIOS

**HW**

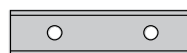

50x12x1,5  
FC612012006  
€ 4,20



14x28x2  
FC61314282  
€ 11,40

**F**  
**R**

## TESTA AD INCLINAZIONE VARIABILE REGOLAZIONE DI 1°/1°

**GB** Pivoting cutter head Adjustable 1°/1°    **F** Porte-outils à chanfreiner Inclinaire de 1°/1°    **E** Cabezal para biselar Ajustable de 1°/1°



**5**  
**5**  
**4**



MAN

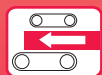

MEC



D	B	d	Z	COD	€
155	50	30	2+2V	FB15550304	670,00

NON VIENE PRODOTTA CON FORO 50 / NOT AVAILABLE WITH BORE 50  
ON NE PRODUIT PAS AVEC ALESAGE 50 / NO SE PRODUCE CON ORIFICIO 50

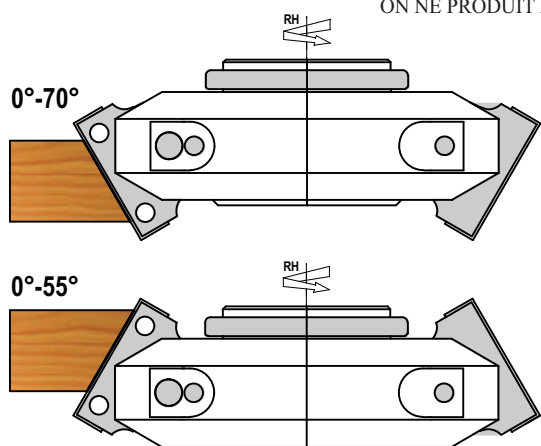

### RICAMBI - SPARE PARTS PIECES DE RECHANGE - RECAMBIOS

**HW**



50x12x1,5  
FC612012006  
€ 4,20



14x28x2  
FC61314282  
€ 11,40

**F**  
**R**

**5**  
**5**  
**6**



MAN

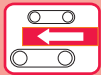

MEC

# TESTA A SPESSORE REGOLABILE CON ANELLI

**GB** Grooving cutterhead adjustable with spacers

**F** Porte-outil a rainier regable avec des bagues

**E** Cabezal para ranurar regulables con anillos

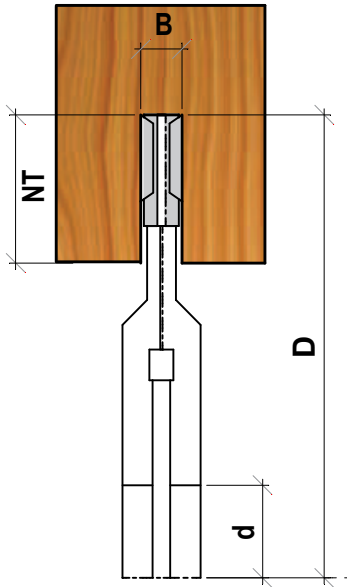

D	B	d	Z	COD	€	NT
150	4-7,5	30	8+4V	FB1504753012	360,00	30
150	4-16	30	8+2+4V	FB1504163014	480,00	30
150	8	30	2	FB1508302	192,00	
180	4-7,5	30	8+4V	FB1804753012	408,00	37
180	4-16	30	8+2+4V	FB1804163014	550,00	37
180	8	30	2	FB1808302	204,00	

## RICAMBI - SPARE PARTS - PIECES DE RECHANGE - RECAMBIOS

**HW**

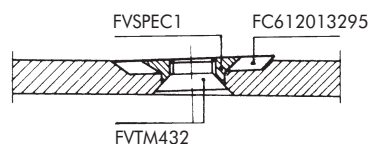
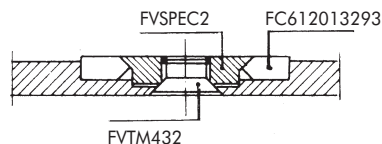

18x18x1,95  
FC612013293  
€ 6,50

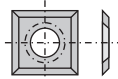

14x14x1,2  
FC612013295  
€ 2,40

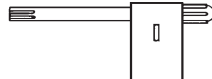

FCT9  
€ 6,00



FVTM432  
€ 3,60



FVSPEC1  
€ 3,60

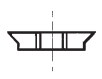

FVSPEC2  
€ 3,60

**F**  
**R**

**5**  
**5**  
**8**



**MAN**

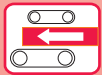

**MEC**

# TESTA A SPESSORE REGOLABILE CON ANELLI



**GB** Grooving cutterhead adjustable with spacers

**F** Porte-outil a rainier regable avec des bagues

**E** Cabezal para ranurar regulables con anillos

D	B	d	Z	COD	€	NT
140	8-15	30	4+4	FB140815308	252,00	35
140	12,5-23	30	4+4	FB14012523308	264,00	35
160	8-15	30	4+4	FB160815308	275,00	45
160	12,5-23	30	4+4	FB16012523308	288,00	45
200	8-15	30	4+4	FB200815308	348,00	65
200	12,5-23	30	4+4	FB20012523308	360,00	65
250	8-15	30	4+4	FB250815308	456,00	60
250	12,5-23	30	4+4	FB25012523308	468,00	90

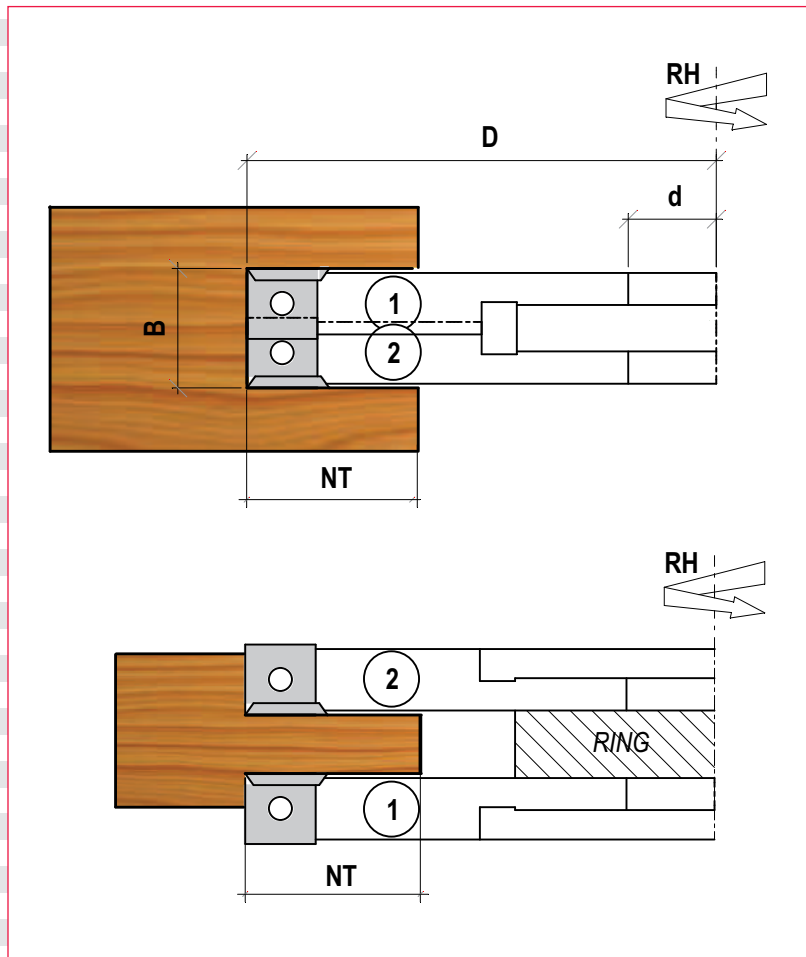

## RICAMBI - SPARE PARTS - PIECES DE RECHANGE - RECAMBIOS

**HW**

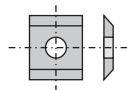

7,5x12x1,5  
FC612012001  
€ 1,80

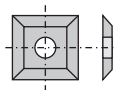

12x12x1,5  
FC612012002  
€ 2,00

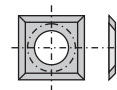

14x14x2  
FC612013273  
€ 2,00

**F**  
**R**

**5**  
**6**  
**0**



MAN

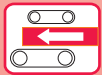

MEC

# TESTA A SPESSORE REGOLABILE CON ANELLI

**GB** Grooving cutterhead adjustable with spacers

**F** Porte-outil a rainier regable avec des bagues

**E** Cabezal para ranurar regulables con anillos



D	B	d	Z	COD	€	NT
140	8-23	30	6+4V	FB1408233010	360,00	35
140	12,5-35	30	6+4V	FB140125353010	372,00	45
140	8-30	30	6+4V	FB1408303010	474,00	35

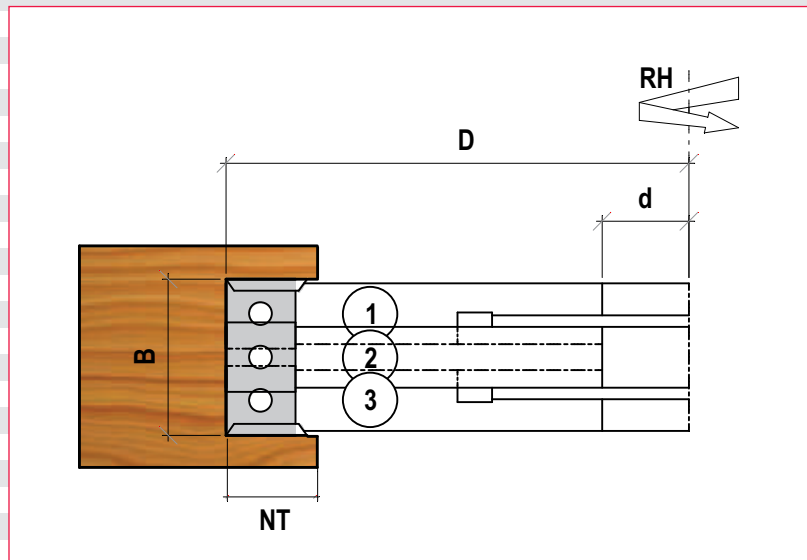

ANELLI PER / RINGS SET FOR /  
BAGUES DE REGLAGE POUR /  
ANILLOS DISTANCIADORES POR /

	COD	€
8-23	AANE5601	36,00
12,5-35	AANE5602	38,00
8-30	AANE5603	42,00

## RICAMBI - SPARE PARTS - PIECES DE RECHANGE - RECAMBIOS

**HW**

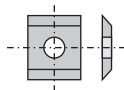

7,5x12x1,5  
FC612012001  
€ 1,80

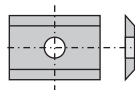

15x12x1,5  
FC612012003  
€ 2,10

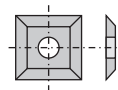

12x12x1,5  
FC612012002  
€ 2,00

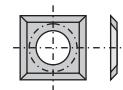

14x14x2  
FC612013273  
€ 2,00

**F**  
**R**

**5**  
**6**  
**2**



MAN

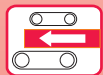

MEC

## TESTA A SPESSORE REGOLABILE CON ANELLI

**GB** Grooving cutterhead adjustable with spacers

**F** Porte-outil à rainier réglable avec des bagues

**E** Cabezal para ranurar regulables con anillos



D	B	d	Z	COD	€	NT
140	20,5-39	30	4+4V	FB14020539308	312,00	35
140	30,5-59	30	4+4V	FB14030559308	324,00	35
160	20,5-39	30	4+4V	FB16020539308	336,00	45
160	30,5-59	30	4+4V	FB16030559308	348,00	45

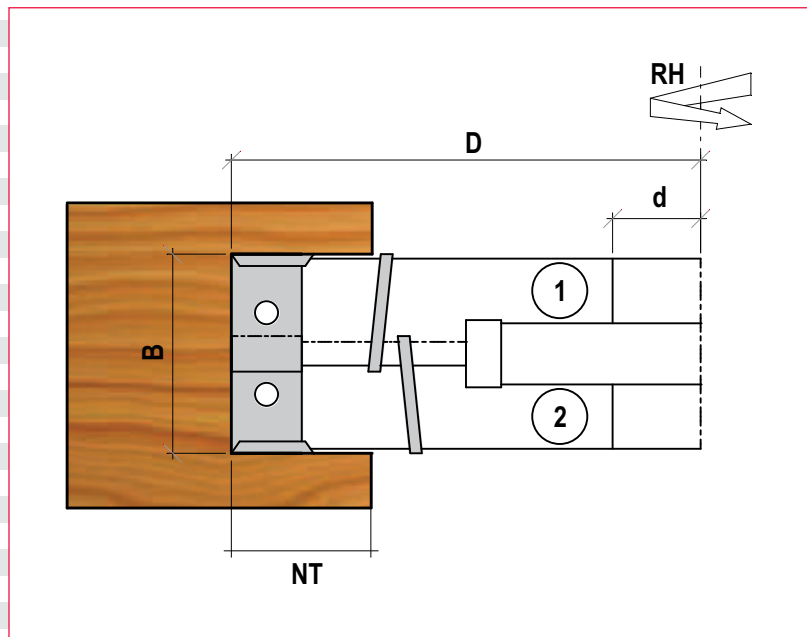

ANELLI PER / RINGS SET FOR /  
BAGUES DE REGLAGE POUR /  
ANILLOS DISTANCIADORES POR /

	COD	€
20,5-39	AANE5621	36,00
30,5-59	AANE5622	60,00

### RICAMBI - SPARE PARTS - PIECES DE RECHANGE - RECAMBIOS

HW

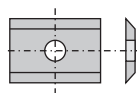

20x12x1,5  
FC612012004  
€ 2,40

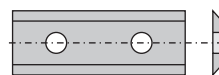

30x12x1,5  
FC612012005  
€ 2,80

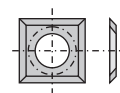

14x14x2  
FC612013273  
€ 2,00

**F**  
**R**

**5**  
**6**  
**4**



MAN

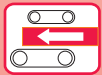

MEC

# TESTA A SPESSORE FISSO

**GB** Fixing grooving cutterhead

**F** Porte-outil a rainier fixe

**E** Cabezal para ranura fisa

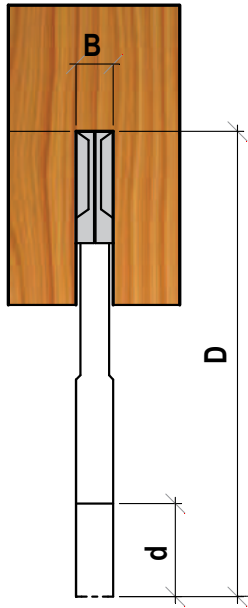

D	B	d	Z	COD	€
125	4	30	4+4V	FB1254308	192,00
125	5	30	4+4V	FB1255308	204,00
125	6	30	4+4V	FB1256308	216,00
150	4	30	4+4V	FB1504308	204,00
150	5	30	4+4V	FB1505308	216,00
150	6	30	4+4V	FB1506308	228,00

## RICAMBI - SPARE PARTS - PIECES DE RECHANGE - RECAMBIOS

**HW**

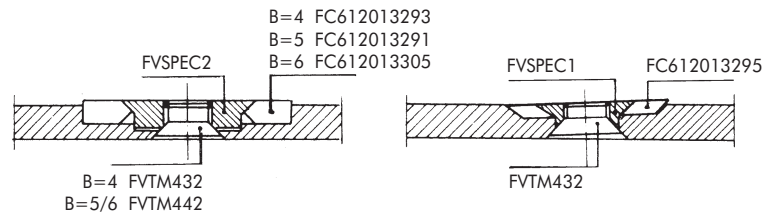

18x18x1,95  
B=4 FC612013293  
€ 6,50

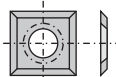

14x14x1,2  
FC612013295  
€ 2,40

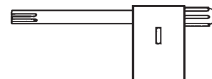

FCT9  
€ 6,00



B=4 FVTM432  
€ 3,60  
B=5/6 FVTM442  
€ 3,60



FVSPEC1  
€ 3,60

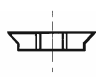

FVSPEC2  
€ 3,60

**F**  
**R**

**5**  
**6**  
**5**



**MAN**

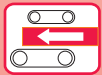

**MEC**

## TESTA A SPESSORE FISSO

**GB** Fixing grooving cutterhead

**F** Porte-outil a rainier fixe

**E** Cabezal para ranura fisa



D	B	d	Z	COD	€
125	8	30	4+4V	FB1258308	228,00
125	10	30	4+4V	FB12510308	240,00
125	12	30	4+4V	FB12512308	252,00
150	8	30	4+4V	FB1508308	240,00
150	10	30	4+4V	FB15010308	252,00
150	12	30	4+4V	FB15012308	264,00

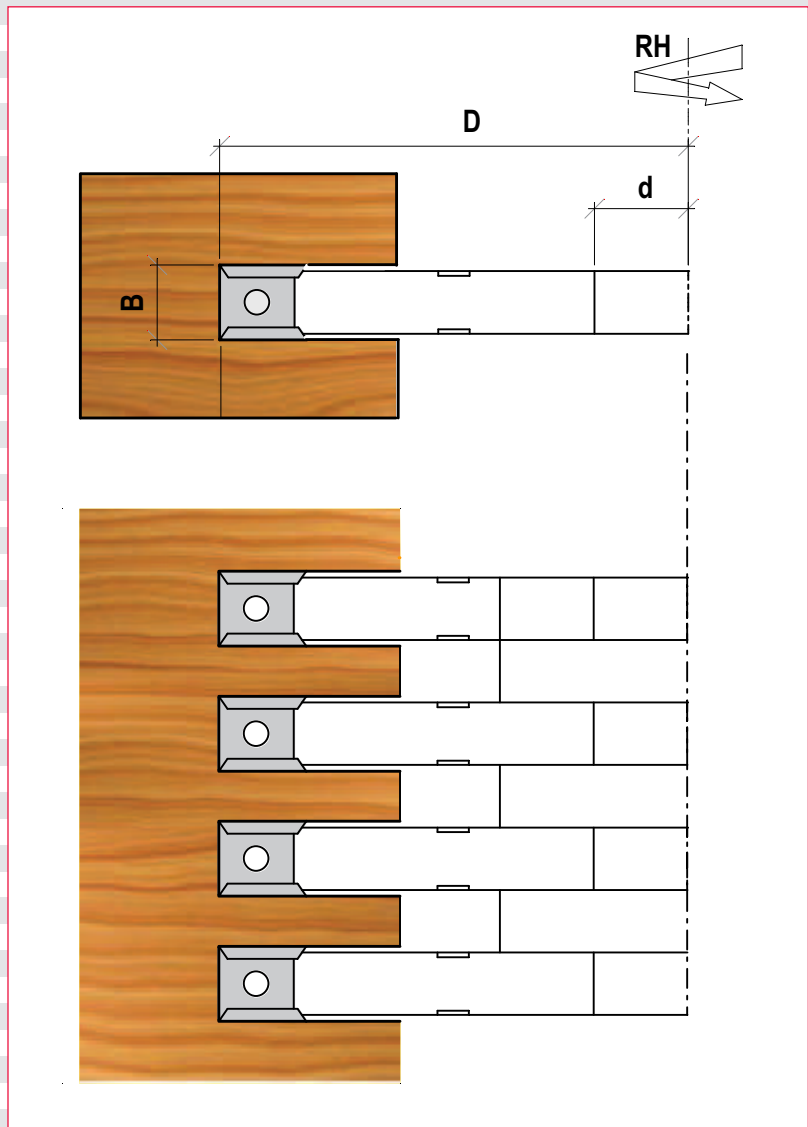

### RICAMBI - SPARE PARTS - PIECES DE RECHANGE - RECAMBIOS

**HW**

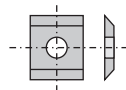

7,5x12x1,5

B=8 FC612012001

€ 1,80

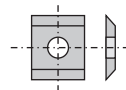

9,6x12x1,5

B=10 FC612012015

€ 2,40

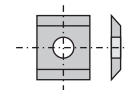

11,6x12x1,5

B=12 FC6131161215

€ 2,80



**F  
R**

**5  
7  
0**



**MAN**

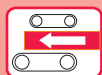

**MEC**

# TESTA PER GIUNZIONI

**GB** Glue joint cutterhead

**F** Porte-outil pour abouter

**E** Cabezal para ensamblar

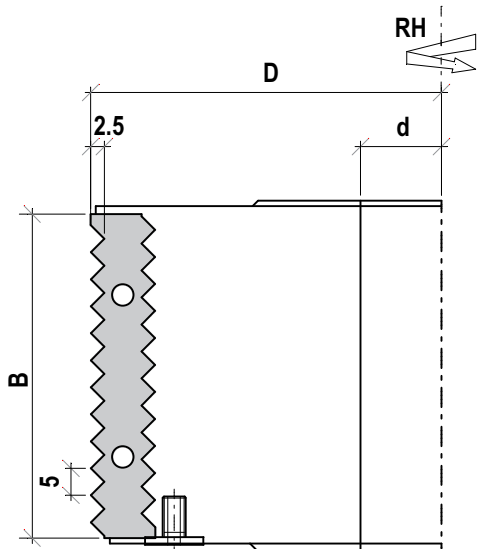

D	B	d	Z	COD	€
125	60	30	3	FJ12560303	360,00
125	80	30	3	FJ12580303	480,00

**MAX 55 mm**

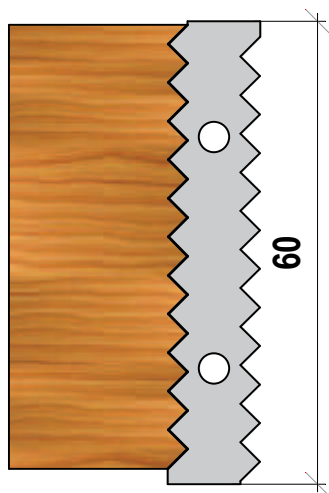

**MAX 75 mm**

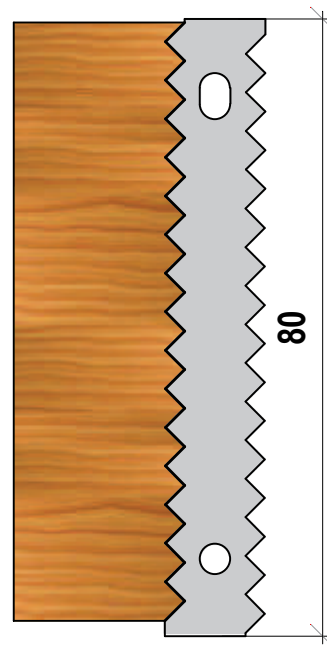

## RICAMBI - SPARE PARTS - PIECES DE RECHANGE - RECAMBIOS

**HW**



**FC61357060**  
€ 28,80



**FC61357080**  
€ 54,00

F  
R

5  
7  
2



MAN

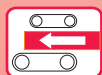

MEC

# GRUPPO TESTE REGOLABILI PER GIUNZIONI

**GB** Adjustable glue joint cutterhead

**F** Porte-outil pour a bouveter extensible

**E** Cabezal extensible para ensamblar

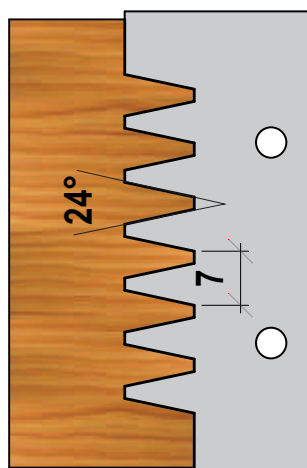
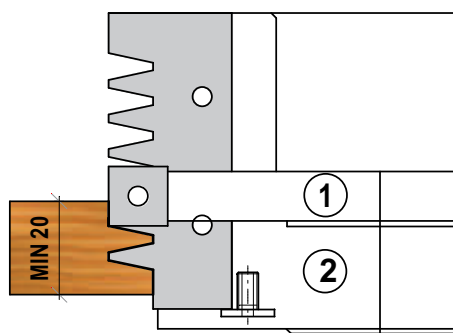
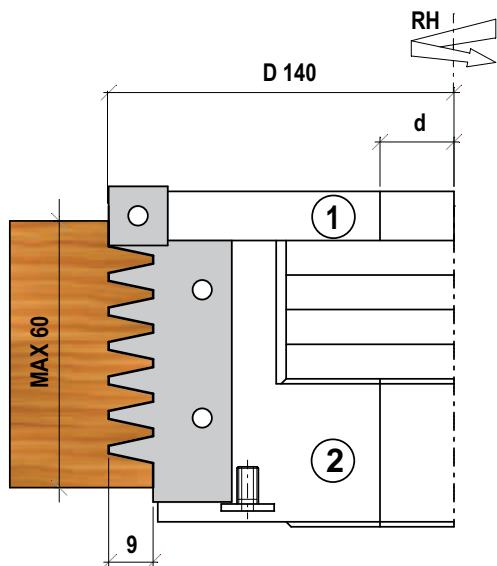

D	B	d	Z	COD	€
140	60+12	30	3+3	FJ1406012306	708,00

## RICAMBI - SPARE PARTS - PIECES DE RECHANGE - RECAMBIOS

**HW**

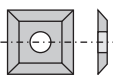

12x12x1,5  
FC612012002  
€ 2,00

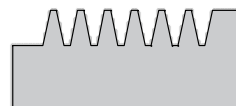

FC61357260  
€ 54,00

**F**  
**R**

**5**  
**7**  
**3**



MAN

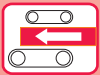

MEC

## TESTA PER GIUNZIONI 45°

**GB** 45° mitre  
glue joint cutterhead

**F** Porte-outil  
pour abouter 45°

**E** Cabezal para  
ensamblar 45°

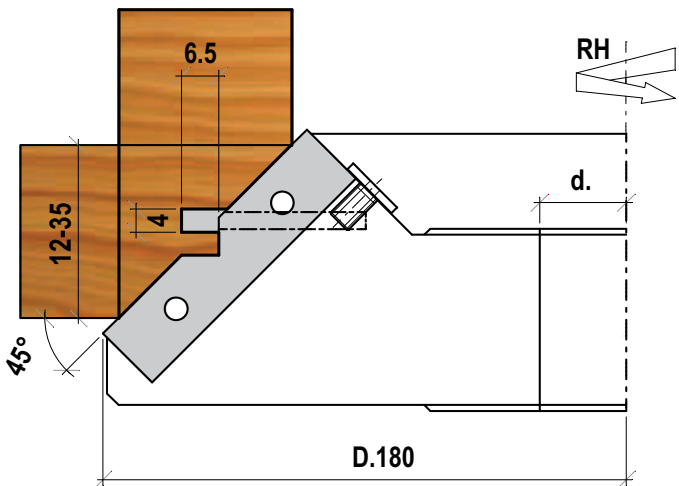
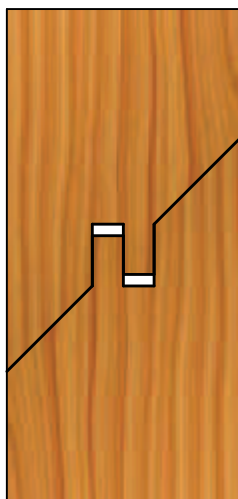
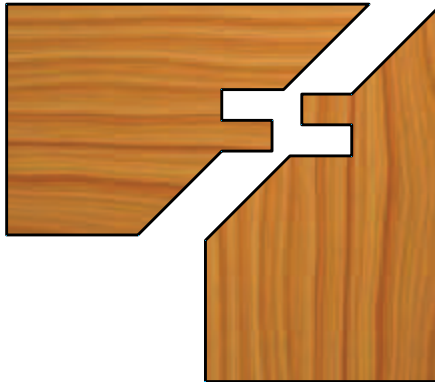

D	B	d	Z	COD	€
180	50	30	2+2	FJ18050304	575,00

### RICAMBI - SPARE PARTS - PIECES DE RECHANGE - RECAMBIOS

**HW**



FC61357350  
€ 18,00



FC6134  
€ 38,00

**F**  
**R**

**5**  
**7**  
**4**



# GRUPPO TESTE PER CONTORNARE - RAGGIARE - SMUSSARE



**GB** Cutterhead set for  
jointig - beveling -  
rounding

**F** Jeu de porte-outils  
pour dresser -  
chanfreiner - arrondir

**E** Juego de cabezales  
para cantear -  
biselar - redondear

## TESTA / HEAD

	D	B	d	Z	COD	€	R
1	125	50	30	3	FB12550303	300,00	
2-3	135	16	30	3	FB13516303	290,00	2-3-4-5-6
4-5	146	25	30	3	FB14625303	420,00	8-10-12
<b>GRUPPO</b>							
1-2-3					FG13516309	718,00	
1-4-5					FG14625309	838,00	

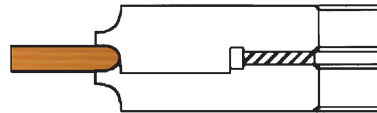
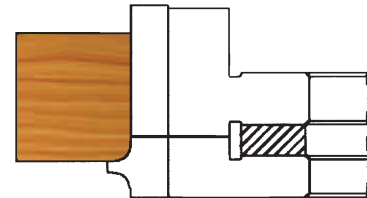
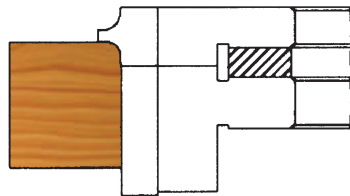
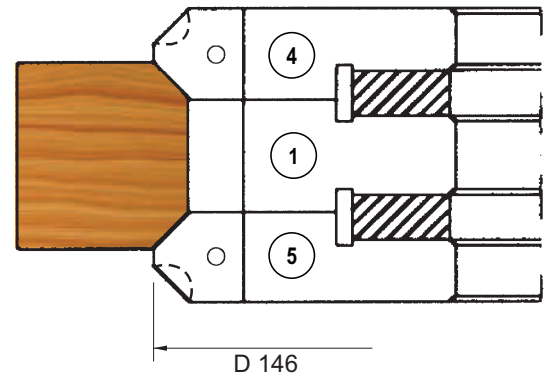
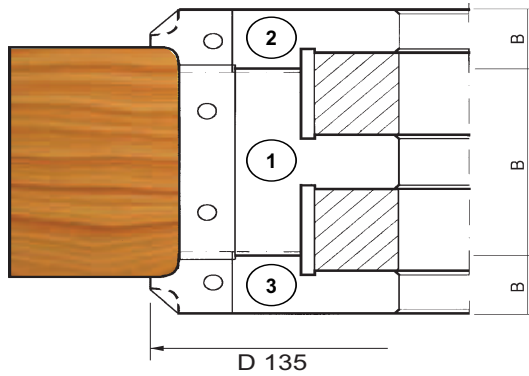

## RICAMBI - SPARE PARTS - PIECES DE RECHANGE - RECAMBIOS

**HW**

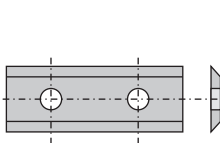

50x12x1,5  
**FC612012006**  
€ 4,20

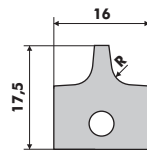

R	COD	€
2	FC613574162	24,00
3	FC613574163	24,00
4	FC613574164	24,00
5	FC613574165	24,00

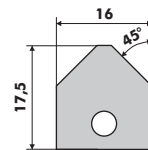

COD	€
FC61357416	20,00

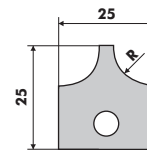

R	COD	€
8	FC613574258	30,00
10	FC6135742510	30,00
12	FC6135742512	30,00

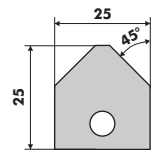

COD	€
FC61357425	30,00

**F**  
**R**

**5**  
**7**  
**6**



MAN

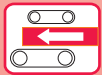

MEC

# TESTA MULTIPROFILO PER ANTINE



Multiprofile cutterhead for doors



Porte-outil multiprofiles pour portes



Cabezal multiperfiles para puertas

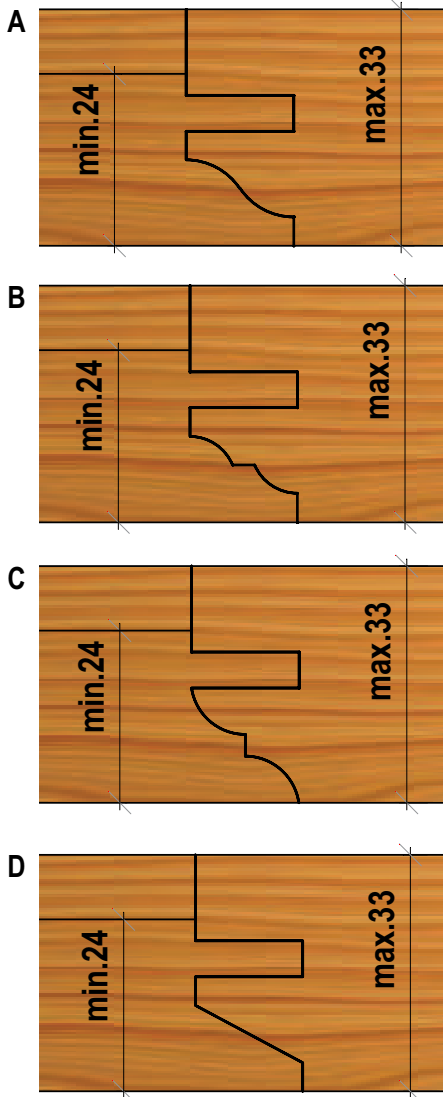

D	B	d	Z	COD	€	PROF
140	50	30	2	FB14050302A	360,00	A
140	50	30	2	FB14050302B	360,00	B
140	50	30	2	FB14050302C	360,00	C
140	50	30	2	FB14050302D	360,00	D

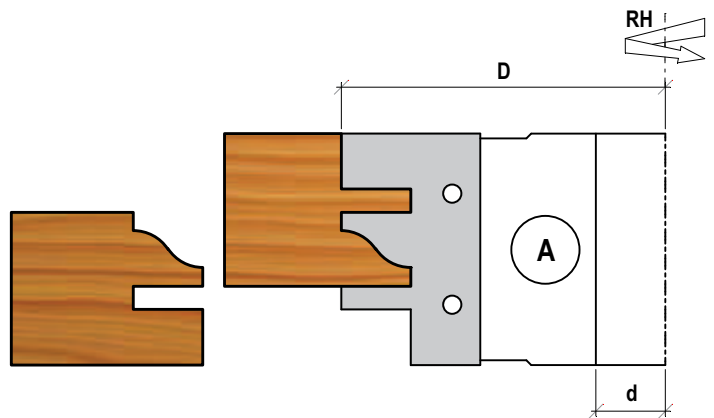

## RICAMBI - SPARE PARTS - PIECES DE RECHANGE - RECAMBIOS

HW

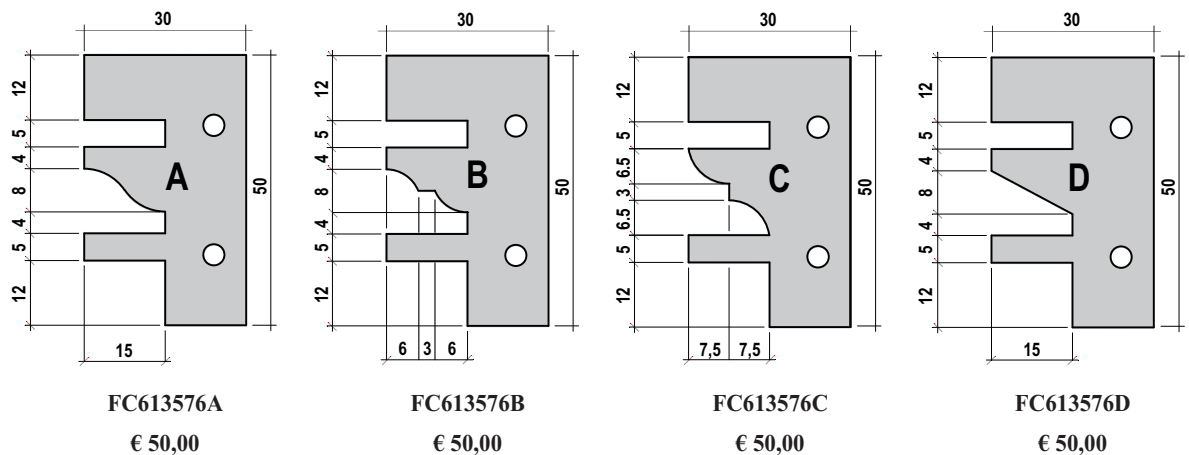

**F**  
**R**

**5**  
**7**  
**8**



MAN

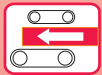

MEC

# GRUPPO TESTE MULTIPROFILO PER ANTINE



Multiprofile cutterhead  
set for doors



Jeu de porte-outil  
multiprofiles pour portes



Juego de cabezal  
multiperfiles  
para puertas

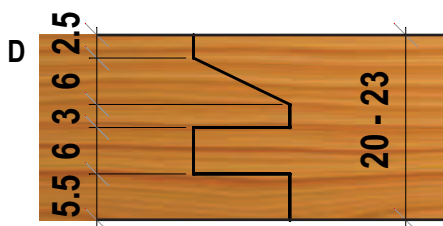
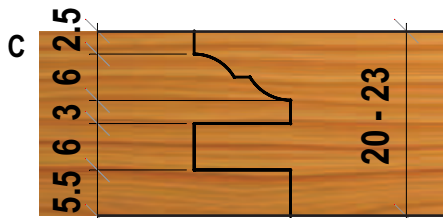
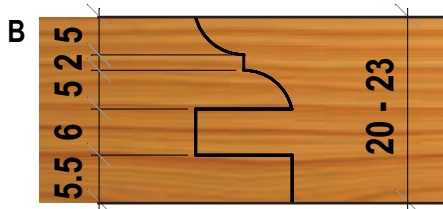
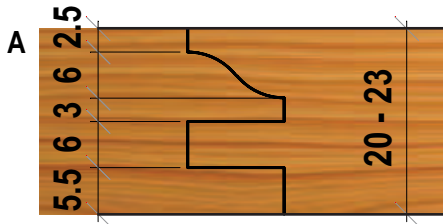

D	B	d	Z	COD	€	PROF
150	12+12	30	2+2	FB1501212304A	480,00	A
150	12+12	30	2+2	FB1501212304B	480,00	B
150	12+12	30	2+2	FB1501212304C	480,00	C
150	12+12	30	2+2	FB1501212304D	480,00	D

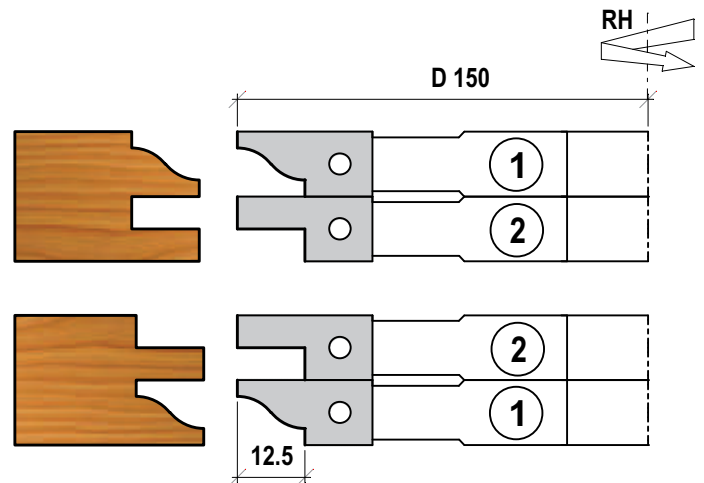

## RICAMBI - SPARE PARTS - PIECES DE RECHANGE - RECAMBIOS

HW



FC6135780  
€ 24,00



FC6135781  
€ 24,00



FC6135782  
€ 24,00



FC6135783  
€ 24,00



FC6135784  
€ 24,00



MAN

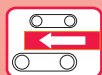

MEC

# GRUPPO TESTE MULTIPROFILO PER ANTINE

**GB** Multiprofile cutterhead set for doors

**F** Jeu de porte-outil multiprofiles pour portes

**E** Juego de cabezal multiperfiles para puertas



N	D	B	d	Z	COD	€	
1	155	20	30	2			
2	155	8-16	30	2+4V			
3	125	12	30	4+4V			
1+2+3	GRUPPO COMPLETO COMPLETE GROUP GROUP COMPLET GRUPO COMPLETO					FG155203016	778,00
4	155	20	30	2	FB15520302	360,00	
5	155	6	30	4+4V	FB1556308	264,00	
6	155	5	30	4+4V	FB1555308	264,00	
7	155	4	30	4+4V	FB1554308	264,00	

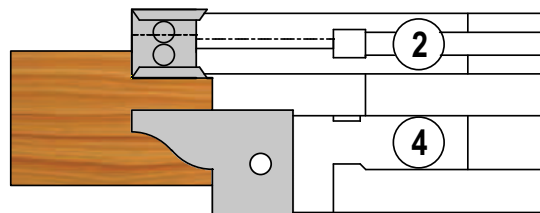
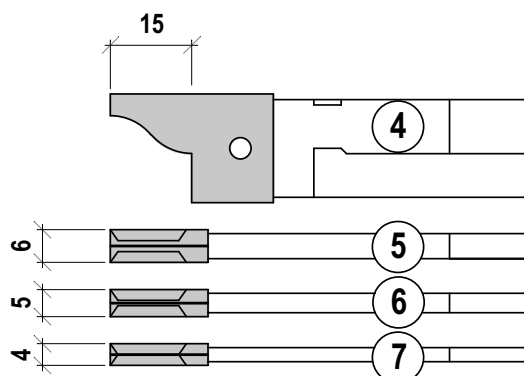
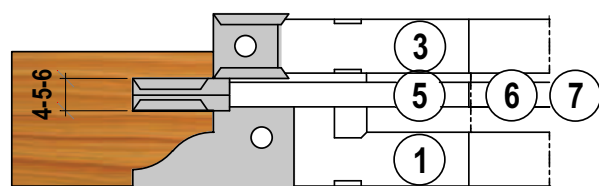
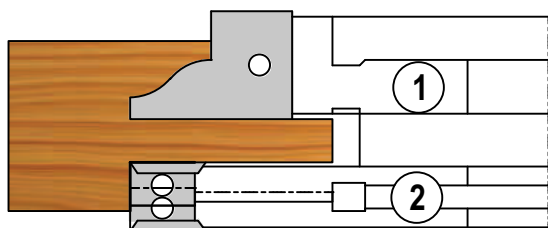
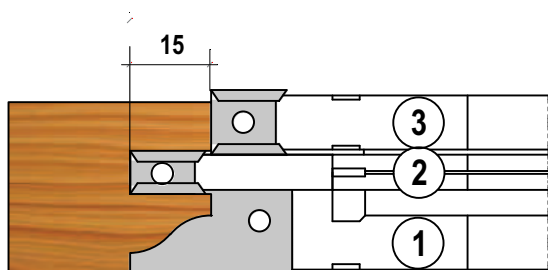



MAN

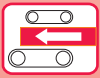

MEC

# GRUPPO TESTE MULTIPROFILO PER ANTINE



Multiprofile cutterhead set for doors



Jeu de porte-outil multiprofiles pour portes



Juego de cabezal multiperfiles para puertas

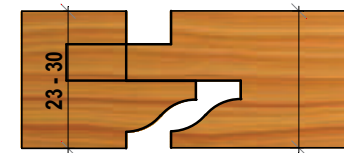
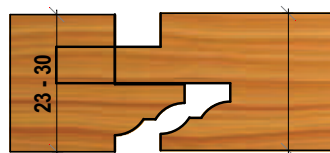
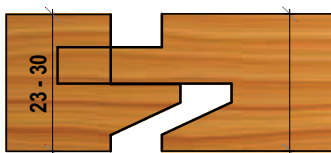
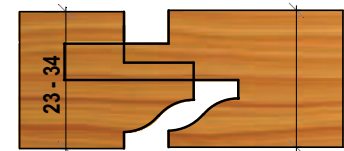
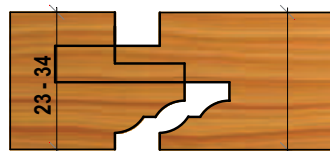
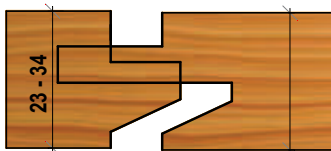
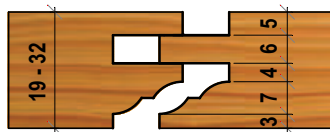
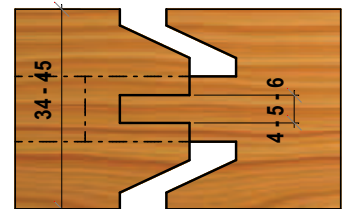
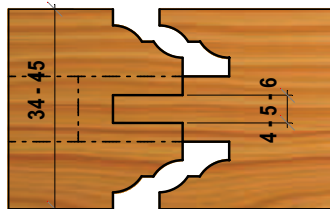
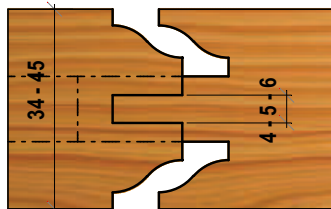
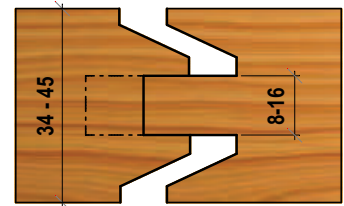
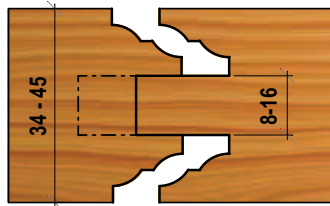
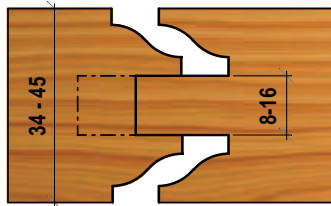
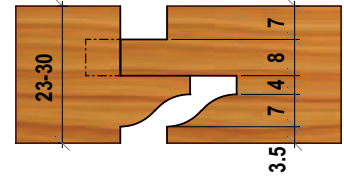
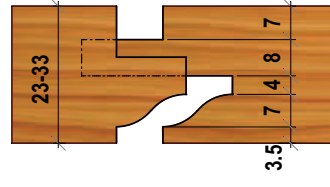
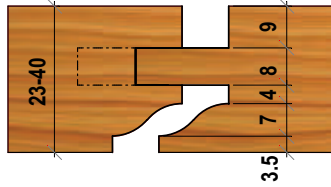

## RICAMBI - SPARE PARTS - PIECES DE - RECHANGE - RECAMBIOS

**HW**

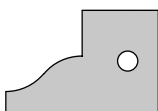

FC6135801  
€ 28,80

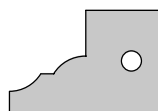

FC6135802  
€ 28,80

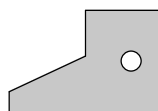

FC6135803  
€ 28,80

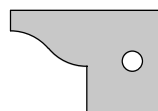

FC6135804  
€ 28,80

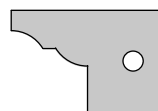

FC6135805  
€ 28,80

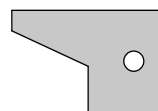

FC6135806  
€ 28,80

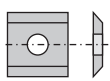

7,5x12x1,5  
FC612012001  
€ 1,80

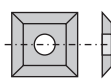

12x12x1,5  
FC612012002  
€ 2,00

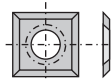

14x14x1,2  
FC612013295  
€ 2,40

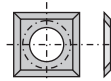

14x14x2  
FC612013273  
€ 2,00

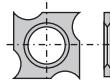

18x18x1,95  
FC612013293  
€ 6,50

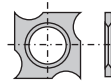

18x18x2,45  
FC612013291  
€ 8,50

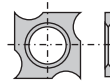

18x18x2,95  
FC612013305  
€ 9,40



**F**  
**R**

## TESTA PER BATTUTE A TAGLIENTI INCLINATI

**GB** Shear angle beating cutterhead **F** Porte-outil pour feuillures avec coupe biais **E** Cabezal para galces corte inclinado



**5**  
**8**  
**2**

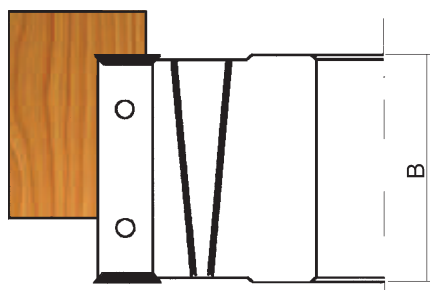

D	B	d	Z	COD	€
125	50	30	4+4V	FB12550308	216,00
125	60	30	4+4V	FB12560308	300,00
140	50	30	4+4V	FB14050308	264,00



MAN



MEC



### RICAMBI - SPARE PARTS - PIECES DE RECHANGE - RECAMBIOS

**HW**

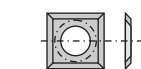

14x14x2  
FC612013273  
€ 2,00



50x12x1,5  
FC612012006  
€ 4,20



60x12x1,5  
FC612012007  
€ 5,30

**F**  
**R**

## TESTA PER BATTUTE A TAGLIENTI DIRITTI

**GB** Beating cutterhead **F** Porte-outil pour feuillures **E** Cabezal para galces



**5**  
**8**  
**6**

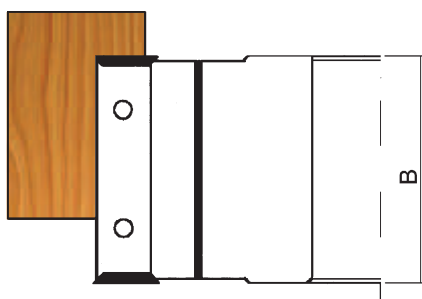

D	B	d	Z	COD	€
100	30	30	2+4V	FB10030306	192,00
100	50	30	2+4V	FB10050306	204,00
125	30	30	2+4V	FB12530306	200,00
125	50	30	2+4V	FB12550306	210,00
125	30	30	4+4V	FB12530308	204,00
125	50	30	4+4V	FB12550308	216,00
125	60	30	4+4V	FB12560308	288,00



MAN

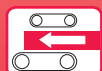

MEC



### RICAMBI - SPARE PARTS - PIECES DE RECHANGE - RECAMBIOS

**HW**

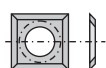

14x14x2  
FC612013273  
€ 2,00

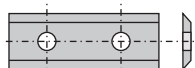

30x12x1,5  
FC612012005  
€ 2,80



50x12x1,5  
FC612012006  
€ 4,20



60x12x1,5  
FC612012007  
€ 5,30

FR

588



## TESTA PER PIALLARE CON TAGLIO ELICOIDALE



Spiral planing  
cutterhead



Porte-outil helicoidal  
a raboter



Cabezales helicoidal  
para cepillar

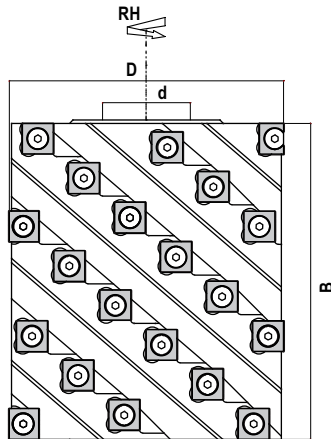

### CORPO IN LEGA LEGGERA - LIGHT ALLOY BODY CORPS EN ALLIAGE LÉGER - CUERPO DE ALEACIÓN LIGERA

D	B	d	Z	COD	€
100	120	35	36	FP1001203536A	538,00
100	190	35	60	FP1001903560A	778,00
125	100	40	30	FP1251004030A	520,00
125	120	40	36	FP1251204036A	598,00
125	130	40	42	FP1251304042A	610,00
125	150	40	48	FP1251504048A	670,00
125	180	40	54	FP1251804054A	838,00
125	230	40	72	FP1252304072A	1078,00
125	260	40	78	FP1252604078A	1196,00
140	120	40	36	FP1401204036A	658,00
140	130	40	42	FP1401304042A	670,00
140	150	40	48	FP1401504048A	730,00
140	180	40	54	FP1401804054A	922,00
140	230	40	72	FP1402304072A	1184,00
140	260	40	78	FP1402604078A	1316,00

SUDDIVISIONE IRREGOLARE DEI TAGLIANTI  
MEDIANTE LA FORMA A SPIRALE

IRREGULAR SUBDIVISION OF THE KNIVES  
THROUGH THE SPIRAL STRUCTURE

SUBDIVISION IRRÉGULIÈRE DES COUTEAUX  
GRÂCE À LA FORME EN SPIRALE

SUBDIVISIÓN IRREGULARE DE LAS CUCHILLAS  
MEDIANTE LA FORMA ESPIRALE

### COLTELLI REVERSIBILI IN HM / HW REVERSIBLE KNIVES PLAQUETTE REVERSIBLES EN HW / CUCHILLAS REVERSIBLES DE HW

#### RICAMBI - SPARE PARTS - PIECES DE RECHANGE - RECAMBIOS

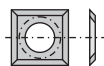
**HW**

14x14x2  
FC612013273  
€ 2,00

A RICHIESTA  
ON REQUEST  
SUR DEMANDE  
SU PREGUNTA

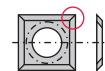

14x14x2  
FC61314142  
€ 3,80



FR

589



FR

589

/ A

# TESTA PER PIALLARE CON TAGLIO ELICOIDALE

**GB** Spiral planing  
cutterhead

**F** Porte-outil helicoidal  
a raboter

**E** Cabezales helicoidal  
para cepillar

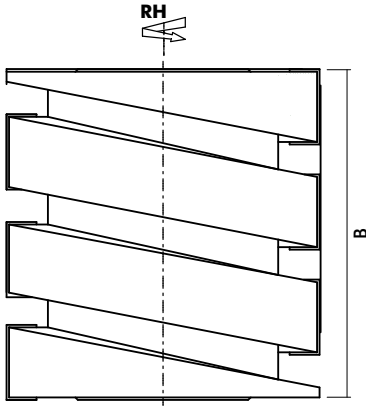

## CORPO IN LEGA LEGGERA - LIGHT ALLOY BODY CORPS EN ALLIAGE LÉGER - CUERPO DE ALEACIÓN LIGERA

D	B	d	Z	COD	€
100	120	35	14	FP1001203514B	466,00
100	130	35	16	FP1001303516B	480,00
100	180	35	24	FP1001803524B	622,00
125	120	40	14	FP1251204014B	480,00
125	130	40	16	FP1251304016B	504,00
125	150	40	18	FP1251504018B	562,00
125	180	40	24	FP1251804024B	646,00
125	230	40	30	FP1252304030B	790,00

SUDDIVISIONE IRREGOLARE DEI TAGLIANTI MEDIANTE LA FORMA A SPIRALE  
IRREGULAR SUBDIVISION OF THE KNIVES THROUGH THE SPIRAL STRUCTURE  
SUBDIVISION IRRÉGULIÈRE DES COUTEAUX GRÂCE À LA FORME EN SPIRALE  
SUBDIVISIÓN IRREGULAR DE LAS CUCHILLAS MEDIANTE LA FORMA ESPIRALE



LAVORA IN COMBINAZIONE CON LE TESTE FR 589  
IT WORKS IN COMBINATION WITH THE HEADS FR 589  
IL TRAVAIL ENSEMBLE AUX TÊTES FR 589  
TRABAJA CONJUNTO A LA CABEZA FR 589

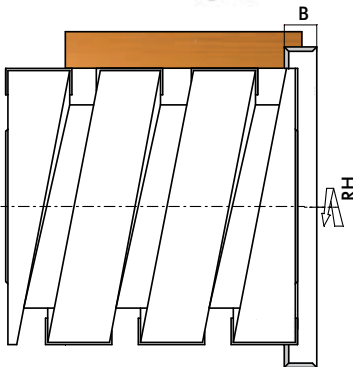

D	B	d	Z	COD	€
120	14,7	35	4+2V	FB1201473542	210,00
145	14,7	40	4+2V	FB1451474042	222,00
160	14,7	40	4+2V	FB1601474042	240,00

## COLTELLI REVERSIBILI IN HM / HW REVERSIBLE KNIVES PLAQUETTE REVERSIBLES EN HW / CUCHILLAS REVERSIBLES DE HW

### RICAMBI - SPARE PARTS - PIECES DE RECHANGE - RECAMBIOS

**HW**

  
14x14x2  
FC612013273  
€ 2,00

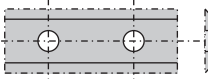
  
30x12x1,5  
FC612012005  
€ 2,80

A RICHIESTA  
ON REQUEST  
SUR DEMANDE  
SU PREGUNTA

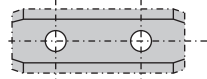
  
30x12x1,5  
FC613301215  
€ 8,20

F  
R  
5  
9  
0

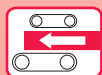

MEC



ALU

## TESTA DA PIALLA CON COLTELLI A BLOCCAGGIO CENTRIFUGO

**GB** Planning cutterhead  
with centrifugal  
fixing system knives

**F** Porte-outil avec couteaux  
à bloc centrifuge

**E** Cabezas con cuchillas  
a bloqueo centrifugo



### CORPO IN LEGA LEGGERA - LIGHT ALLOY BODY CORPS EN ALLIAGE LÉGER CUERPO DE ALEACIÓN LIGERA

IL BLOCCAGGIO CENTRIFUGO  
CONSENTE LA SOSTITUZIONE RAPIDA  
E PRECISA DEI COLTELLI.

THE CENTRIFUGAL FIXING SYSTEM  
ALLOWS FAST AND PRECISE KNIFE  
CHANGE.

LE BLOC CENTRIFUGE PERMET LE  
REMPACEMENT RAPIDE ET PRÉCIS  
DES COUTEAUX

EL BLOQUEO CENTRIFUGO CONSIENTE  
LA SOSTITUCIÓN RAPIDA Y PRECISA  
DE LA CUCHILLAS

D	B	d	Z	COD	€
100	100	35	4	FP100100354C	294,00
100	130	35	4	FP100130354C	358,00
100	180	35	4	FP100180354C	618,00
125	100	40	4	FP125100404C	328,00
125	130	40	4	FP125130404C	420,00
125	140	40	4	FP125140404C	446,00
125	150	40	4	FP125150404C	475,00
125	160	40	4	FP125160404C	493,00
125	170	40	4	FP125170404C	514,00
125	180	40	4	FP125180404C	540,00
125	190	40	4	FP125190404C	585,00
125	210	40	4	FP125210404C	618,00
125	230	40	4	FP125230404C	660,00
125	240	40	4	FP125240404C	715,00
140	100	40	4	FP140100404C	400,00
140	130	40	4	FP140130404C	504,00
140	140	40	4	FP140140404C	534,00
140	150	40	4	FP140150404C	566,00
140	160	40	4	FP140160404C	611,00
140	170	40	4	FP140170404C	650,00
140	180	40	4	FP140180404C	702,00
140	190	40	4	FP140190404C	748,00
140	210	40	4	FP140210404C	793,00
140	230	40	4	FP140230404C	814,00
140	240	40	4	FP140240404C	845,00
160	100	40	6	FP160100406C	507,00
160	130	40	6	FP160130406C	644,00
160	140	40	6	FP160140406C	690,00
160	150	40	6	FP160150406C	738,00
160	160	40	6	FP160160406C	788,00
160	170	40	6	FP160170406C	840,00
160	180	40	6	FP160180406C	878,00
160	190	40	6	FP160190406C	930,00
160	210	40	6	FP160210406C	975,00
160	230	40	6	FP160230406C	1058,00
160	240	40	6	FP160240406C	1106,00

### RICAMBI - SPARE PARTS - PIECES DE RECHANGE - RECAMBIOS

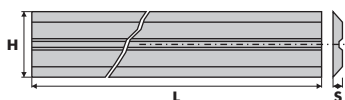

COLTELLI CENTROLOCK ART FR 602 PAG. 187 / KNIVES CENTROLOCK ART FR 602 PAG. 187  
COUTEAUX CENTROLOCK ART FR 602 PAG. 187 / CUCHILLAS CENTROLOCK ART FR 602 PAG. 187



# TESTA DA PIALLA

**GB** Planing cutterhead

**F** Porte-outil a raboter

**E** Cabezales para cepillar



## CORPO IN LEGA LEGGERA - LIGHT ALLOY BODY CORPS EN ALLIAGE LÉGER CUERPO DE ALEACIÓN LIGERA

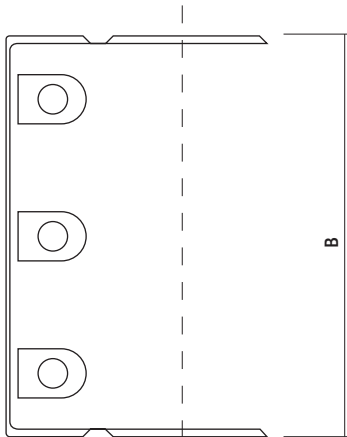

D	B	d	Z	COD	€
100	120	35	4	FP100120354DA	300,00
100	190	35	4	FP100190354DA	384,00
125	100	40	4	FP125100404DA	260,00
125	120	40	4	FP125120404DA	294,00
125	130	40	4	FP125130404DA	325,00
125	150	40	4	FP125150404DA	358,00
125	160	40	4	FP125160404DA	390,00
125	170	40	4	FP125170404DA	408,00
125	180	40	4	FP125180404DA	424,00
125	190	40	4	FP125190404DA	440,00
125	210	40	4	FP125210404DA	472,00
125	230	40	4	FP125230404DA	504,00
125	240	40	4	FP125240404DA	520,00
125	250	40	4	FP125250404DA	536,00

TESTE PORTA COLTELLI CON COLTELLI AL 13%CR H=30  
CUTTERBLOCKS WITH KNIVES QUALITY 13%CR H=30  
TÊTE PORTE-COUTEAUX AVEC COUTEAUX A 13%CR H=30  
CABEZAS PUERTAS-CUCHILLAS CON CUCHILLAS 13%CR H=30

## CORPO IN ACCIAIO - STEEL BODY CORPS IN ACIER - CUERPO DE ACERO

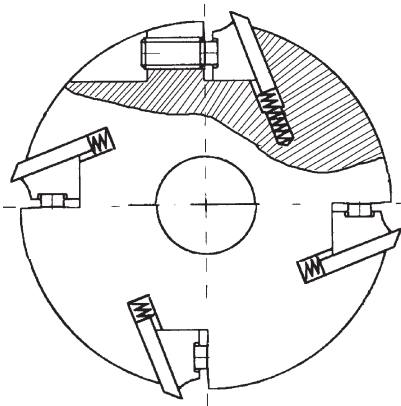

D	B	d	Z	COD	€
100	120	35	4	FP100120354DS	300,00
100	190	35	4	FP100190354DS	384,00
125	100	40	4	FP125100404DS	260,00
125	120	40	4	FP125120404DS	294,00
125	130	40	4	FP125130404DS	325,00
125	150	40	4	FP125150404DS	358,00
125	160	40	4	FP125160404DS	390,00
125	170	40	4	FP125170404DS	408,00
125	180	40	4	FP125180404DS	424,00
125	190	40	4	FP125190404DS	440,00
125	210	40	4	FP125210404DS	472,00
125	230	40	4	FP125230404DS	504,00
125	240	40	4	FP125240404DS	520,00
125	250	40	4	FP125250404DS	536,00

TESTE PORTA COLTELLI CON COLTELLI AL 13%CR H=30  
CUTTERBLOCKS WITH KNIVES QUALITY 13%CR H=30  
TÊTE PORTE-COUTEAUX AVEC COUTEAUX A 13%CR H=30  
CABEZAS PUERTAS-CUCHILLAS CON CUCHILLAS 13%CR H=30

**RICAMBI**  
COLTELLI DA PIALLA  
H=30 ART FR 598 PAG. 185

**SPARE PARTS**  
PLANING KNIVES  
H=30 ART FR 598 PAG. 185

**PIECES DE RECHANGE**  
COUTEAUX DE RABOTEUSE  
H=30 ART FR 598 PAG. 185

**RECAMBIOS**  
CUCHILLAS CEPILLADORES  
H=30 ART FR 598 PAG. 185

COPPIA DI CALIBRI AD ANELLO PER TESTE ART FR 592  
PAIR OF RING GAUGES FOR HEADS ART FR 592

COUPLE DE JAUGES EN BAGUE  
POUR TÊTES ART FR 592  
PAREJA DE CALIBRES A ANILLOS  
POR CABEZAS ART FR 592

COD. FXCALIBRO100 € 145,00  
COD. FXCALIBRO125 € 145,00

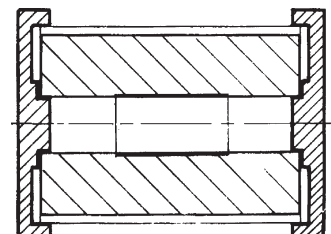

**F**  
**R**

**5**  
**9**  
**3**



# TESTA PORTACOLTELLI ZIGRINATI

**GB** Cutterhead for corrugated knives

**F** Porte-outil avec plaquettes crantées

**E** Cabezal para cuchillas grafiladas

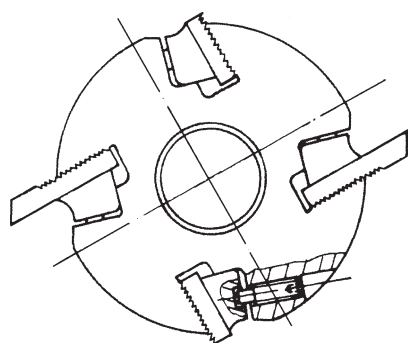

D	B	d	Z	COD	€
122	40	40	4	FP12240404E	190,00
122	60	40	4	FP12260404E	218,00
122	80	40	4	FP12280404E	244,00
122	100	40	4	FP122100404E	264,00
122	130	40	4	FP122130404E	306,00
122	150	40	4	FP122150404E	330,00
122	180	40	4	FP122180404E	356,00
122	230	40	4	FP122230404E	420,00
137	40	40	4	FP13740404E	222,00
137	60	40	4	FP13760404E	252,00
137	80	40	4	FP13780404E	278,00
137	100	40	4	FP137100404E	304,00
137	130	40	4	FP137130404E	345,00
137	150	40	4	FP137150404E	374,00
137	180	40	4	FP137180404E	408,00
137	230	40	4	FP137230404E	488,00

FORNITA SENZA COLTELLI / PROVIDED WITHOUT KNIVES  
FOURNIE SANS COUTEAUX / ABASTECIDA SIN CUCHILLAS

## ALTEZZA MAX SAGOMA

PROFILE'S MAX HEIGHT  
HAUTEUR MAXIMAL MODÈLE  
ALTURA MÁXIMA PERFIL

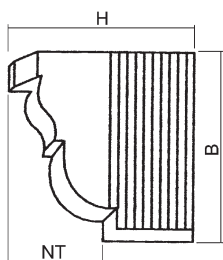

H	NT HSS	NT HM/HW
50	12	12
60	20	20
70	30	25

**CON TESTA D=122**  
WITH HEAD D=122  
AVEC TÊTE D=122  
CON CABEZA D=122

Altezza coltelli  
Knives height  
Hauteur couteaux  
Altura cuchillas

H	D MAX
50	160
60	180
70	200

**CON TESTA D=137**  
WITH HEAD D=137  
AVEC TÊTE D=137  
CON CABEZA D=137

Altezza coltelli  
Knives height  
Hauteur couteaux  
Altura cuchillas

H	D MAX
50	175
60	195
70	215

## RICAMBI - SPARE PARTS - PIECES DE RECHANGE - RECAMBIOS

COLTELLI CORRUGATI ART. FR 600 PAG. 186  
CORRUGATED KNIVES ART. FR 600 PAG. 186  
COUTEAUX BRUTS ART. FR 600 PAG. 186  
CUCHILLAS PERFILAR ART. FR 600 PAG. 186

**F**  
**R**

**5**  
**9**  
**4**



# TESTA PORTACOLTELLI A SERRAGGIO IDRAULICO

**GB** Cutterhead with hydraulic centering and clamping

**F** Tête porte-couteaux avec serrage hydraulique

**E** Cabeza puertacuchillas con ajuste hidráulico

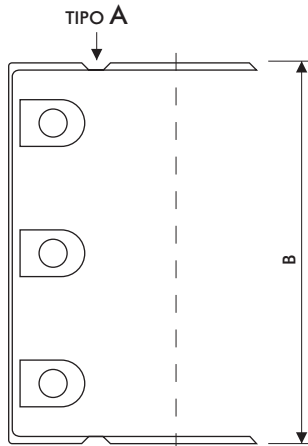

INGRASSATORE ASSIALE  
AXIAL GREASE NIPPLES  
GRAISSEUR AXIAL  
ENGRASADOR AXIAL

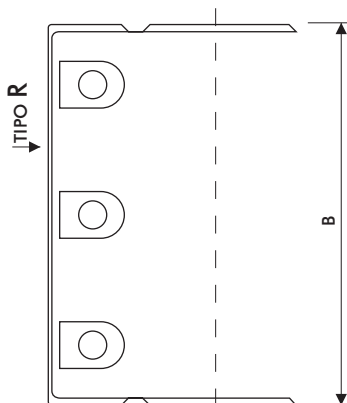

INGRASSATORE RADIALE  
RADIAL GREASE NIPPLES  
GRAISSEUR RADIAL  
ENGRASADOR RADIAL

PRESSIONE DI SERRAGGIO MASSIMA  
MAXIMUM BUSH CLAMPING PRESSURE  
PRESSION DE SERRAGE MAXIMALE  
PRESIÓN D'AJUSTE MÁXIMA  
**450 Bar**

D	B	d	Z	TIPO A COD	TIPO R COD
143	60	40	4	FP14360404FA	FP14360404FR
143	100	40	4	FP143100404FA	FP143100404FR
143	130	40	4	FP143130404FA	FP143130404FR
143	150	40	4	FP143150404FA	FP143150404FR
143	160	40	4	FP143160404FA	FP143160404FR
143	230	40	4	FP143230404FA	FP143230404FR
163	60	40	4	FP16360404FA	FP16360404FR
163	100	40	4	FP163100404FA	FP163100404FR
163	130	40	4	FP163130404FA	FP163130404FR
163	150	40	4	FP163150404FA	FP163150404FR
163	160	40	4	FP163160404FA	FP163160404FR
163	170	40	4	FP163170404FA	FP163170404FR
163	180	40	4	FP163180404FA	FP163180404FR
163	230	40	4	FP163230404FA	FP163230404FR
163	240	40	4	FP163240404FA	FP163240404FR
163	260	40	4	FP163260404FA	FP163260404FR
163	310	40	4	FP163310404FA	FP163310404FR
203	100	40	6	FP203100406FA	FP203100406FR
203	150	40	6	FP203150406FA	FP203150406FR
203	160	40	6	FP203160406FA	FP203160406FR
203	230	40	6	FP203230406FA	FP203230406FR
203	260	40	6	FP203260406FA	FP203260406FR
203	310	40	6	FP203310406FA	FP203310406FR

PREZZI A RICHIESTA / PRICE ON REQUEST  
PRIX SUR DEMANDE / PRECIOS SU PREGUNTA

TESTA PORTACOLTELLI COSTRUITA IN ACCIAIO AD ALTA RESISTENZA CON UN DISPOSITIVO PER IL SERRAGGIO IDRAULICO DELL'UTENSILE SULL'ALBERO DELLA MACCHINA.

CUTTERHEAD WITH HYDRAULIC CENTERING AND CLAMPING. TOOL BODY IS MADE OF HIGH TENSILE STEEL AND THE LOCKING ON THE MACHINES SPINDLE IS ACHIEVED WITH TWO SPECIAL SLEEVES.

TÊTE PORTE-COUTEAUX FAITE EN ACIER À HAUTE RESISTANCE AVEC UN DESPOSITIF POUR LE SERRAGE HYDRAULIQUE DE L'OUTIL SUR L'ARBRE DE LA MACHINE.

CABEZA PUERTAS-CUCHILLAS HECHO D'ACERO CON UNO MECANISMO PARA EL AJUSTE HIDRAÚLICO DEL HERRAMIENTA SOBRE EL ÁRBOL DE LA MÁQUINA.

**Si costruiscono anche teste**  
**We produce heads too**  
**On produit aussi des têtes**  
**Producimos tambien cabezas**

Ø 163 Z=6-8

Ø 203 Z=8-10-12-16

## RICAMBI - SPARE PARTS - PIECES DE RECHANGE - RECAMBIOS

COLTELLI DA PIALLA H=30 ART. FR 598 PAG. 185

PLANING KNIVES H=30 ART. FR 598 PAG. 185

COUTEAUX DE RABOTEUSE H=30 ART. FR 598 PAG. 185

CUCHILLAS CEPILLADORES H=30 ART. FR 598 PAG. 185



# TESTA PORTACOLTELLI ZIGRINATI A SERRAGGIO IDRAULICO

**GB** Cutterhead with hydraulic centering and clamping for profiled knives

**F** Tête porte-couteaux moletée avec serrage hydraulique

**E** Cabeza puertas-cuchillas graneados con ajuste hidráulico

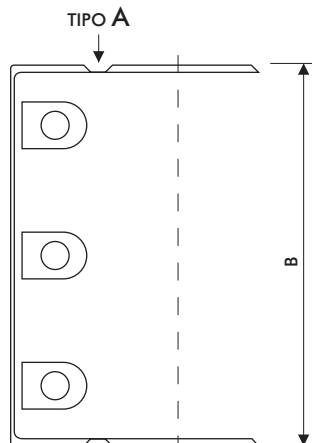

INGRASSATORE ASSIALE  
AXIAL GREASE NIPPLES  
GRAISSEUR AXIAL  
ENGRASADOR AXIAL

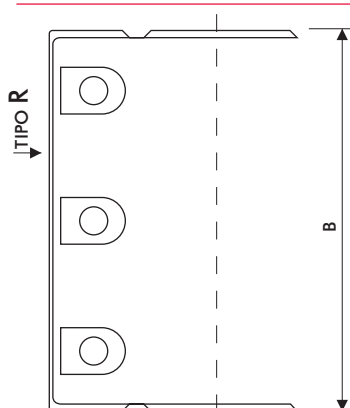

INGRASSATORE RADIALE  
RADIAL GREASE NIPPLES  
GRAISSEUR RADIAL  
ENGRASADOR RADIAL

PRESSIONE DI SERRAGGIO MASSIMA  
MAXIMUM BUSH CLAMPING PRESSURE  
PRESSION DE SERRAGE MAXIMALE  
PRESIÓN D'AJUSTE MÁXIMA

450 Bar

## RICAMBI

COLTELLI CORRUGATI  
ART FR 600 PAG. 186

## SPARE PARTS

CORRUGATED KNIVES  
ART FR 600 PAG. 186

## PIECES DE RECHANGE

COUTEAUX BRUTS  
ART FR 600 PAG. 186

## RECAMBIOS

CUCHILLAS PER FILAR  
ART FR 600 PAG. 186

D	B	d	Z	TIPO A COD	TIPO R COD
137	60	40	4	FP13760404GA	FP13760404GR
137	100	40	4	FP137100404GA	FP137100404GR
137	150	40	4	FP137150404GA	FP137150404GR
152	60	40	4	FP15260404GA	FP15260404GR
152	100	40	4	FP152100404GA	FP152100404GR
152	150	40	4	FP152150404GA	FP152150404GR
152	230	40	4	FP152230404GA	FP152230404GR
152	60	40	6	FP15260406GA	FP15260406GR
152	100	40	6	FP152100406GA	FP152100406GR
152	130	40	6	FP152130406GA	FP152130406GR
152	150	40	6	FP152150406GA	FP152150406GR
152	180	40	6	FP152180406GA	FP152180406GR
152	230	40	6	FP152230406GA	FP152230406GR
152	260	40	6	FP152260406GA	FP152260406GR
152	310	40	6	FP152310406GA	FP152310406GR
163	60	40	8	FP16360408GA	FP16360408GR
163	100	40	8	FP163100408GA	FP163100408GR
163	130	40	8	FP163130408GA	FP163130408GR
163	150	40	8	FP163150408GA	FP163150408GR
163	230	40	8	FP163230408GA	FP163230408GR
163	260	40	8	FP163260408GA	FP163260408GR
163	310	40	8	FP163310408GA	FP163310408GR

PREZZI A RICHIESTA / PRICE ON REQUEST  
PRIX SUR DEMANDE / PRECIOS SU PREGUNTA

TESTA PORTACOLTELLI COSTRUITA IN ACCIAIO AD ALTA RESISTENZA  
CON UN DISPOSITIVO PER IL SERRAGGIO IDRAULICO DELL'UTENSILE  
SULL'ALBERO DELLA MACCHINA.

CUTTERHEAD WITH HYDRAULIC CENTERING AND CLAMPING. TOOL BODY IS  
MADE OF HIGH TENSILE STEEL AND THE LOCKING ON THE MACHINES SPINDLE  
IS ACHIEVED WITH TWO SPECIAL SLEEVES.

TÊTE PORTE-COUTEAUX FAITE EN ACIER À HAUTE RESISTANCE  
AVEC UN DESPOSITIF POUR LE SERRAGE HYDRAULIQUE DE L'OUTIL SUR  
L'ARBRE DE LA MACHINE.

CABEZA PUERTAS-CUCHILLAS HECHO D'ACERO CON UNO MECANISMO PARA  
EL AJUSTE HIDRAÚLICO DEL HERRAMIENTA SOBRE EL ÁRBOL DE LA MÁQUINA.

## DIAMETRO MASSIMO CON COLTELLI

DIAMETER MAX WITH KNIVES  
DIAMÈTRE MAXIMAL AVEC COUTEAUX  
DIÁMETRO MÁXIMO CON CUCHILLAS

Ø	H	Ø MAX	Ø	H	Ø MAX	Ø	H	Ø MAX
137	50	170	152	50	185	163	50	198
137	60	190	152	60	205	163	60	218
137	70	210	152	70	225	163	70	238

## ALTEZZA MAX SAGOMA

HEIGHT MAX OF PROFILE  
HAUTER MAXIMALE AVEC COUTEAUX  
ALTURA MÁXIMA DEL PERFIL

H	NT HSS	NT HM/HW
50	12	12
60	20	20
70	30	25

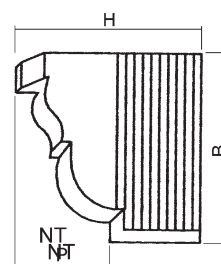



### Coltelli da pialla

Planing knives

Couteaux de raboteuse

Cuchillas cepilladoras

### FR 598

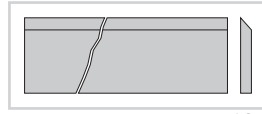

185

### Coltelli corrugati profilabili da pialla

Corrugated knives for cutterhead

Couteaux bruts pour porte-outils

Cuchillas a perfilar para cabezail

### FR 600

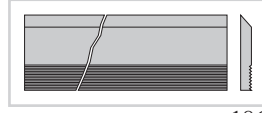

186

### Coltelli reversibili

Reversible knives

Plaquettes reversibles

Cuchillas reversibles

### FR 602

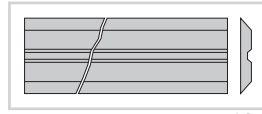

187

### FR 603

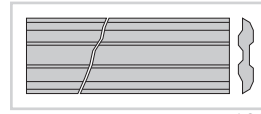

188

### FR 604

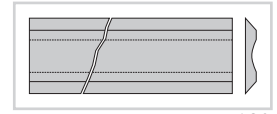

189

### FR 605

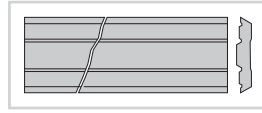

190

### FR 606

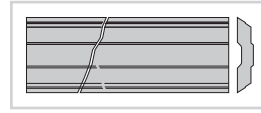

191

### FR 607

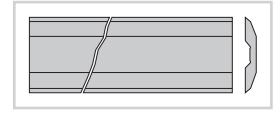

192

### FR 608

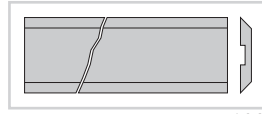

193

### FR 609

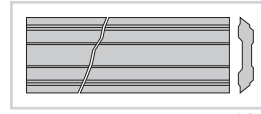

193

### Coltelli reversibili in HM

HW reversible knives

Plaquettes reversibles en HW

Cuchillas reversibles de HW

### FR 612

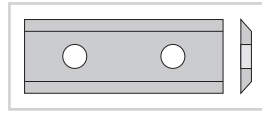

194-195

### FR 612

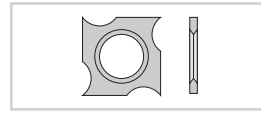

194-195

### Lame per seghe a nastro per legno

Band saw blades

Lames de scies a ruban

Hojas de sierra de cinta

### SN 650



196

## COLTELLI DA PIALLA

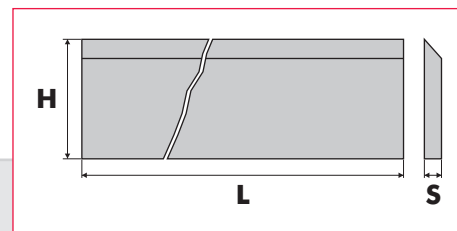

**GB** Planing knives

**F** Couteaux de raboteuse

**E** Cuchillas cepilladoras

L	H	S	COD	HSS 18% W€	COD	HM€
60	30	3	FC59860301	3,40	FC59860302	15,60
80	30	3	FC59880301	4,50	FC59880302	18,80
100	30	3	FC598100301	5,60	FC598100302	21,20
110	30	3	FC598110301	6,10	FC598110302	22,20
120	30	3	FC598120301	6,70	FC598120302	24,20
130	30	3	FC598130301	7,20	FC598130302	26,20
140	30	3	FC598140301	7,80	FC598140302	28,30
150	30	3	FC598150301	8,30	FC598150302	30,30
160	30	3	FC598160301	8,90	FC598160302	32,30
170	30	3	FC598170301	9,40	FC598170302	34,30
180	30	3	FC598180301	10,00	FC598180302	36,30
200	30	3	FC598200301	11,10	FC598200302	40,30
210	30	3	FC598210301	11,60	FC598210302	42,40
220	30	3	FC598220301	12,20	FC598220302	44,40
230	30	3	FC598230301	12,70	FC598230302	46,40
250	30	3	FC598250301	13,90	FC598250302	50,40
300	30	3	FC598300301	16,60	FC598300302	60,50
310	30	3	FC598310301	17,20	FC598310302	62,50
350	30	3	FC598350301	19,40	FC598350302	70,60
400	30	3	FC598400301	22,10	FC598400302	80,60
410	30	3	FC598410301	22,70	FC598410302	82,70
430	30	3	FC598430301	23,80	FC598430302	86,70
450	30	3	FC598450301	24,90	FC598450302	90,70
460	30	3	FC598460301	25,50	FC598460302	92,70
500	30	3	FC598500301	27,70	FC598500302	100,80
510	30	3	FC598510301	28,20	FC598510302	102,80
520	30	3	FC598520301	28,80	FC598520302	104,80
530	30	3	FC598530301	29,30	FC598530302	106,80
600	30	3	FC598600301	33,20	FC598600302	120,90
700	30	3	FC598700301	38,70	FC598700302	141,10
810	30	3	FC598810301	44,80	FC598810302	163,30
1000	30	3	FC5981000301	55,30	FC5981000302	201,50
1070	30	3	FC5981070301	59,20	FC5981070302	215,60

MISURE SPECIALI A RICHIESTA ORDINE MINIMO 6 PEZZI - € AL METRO 55,30 201,50

*Special measures on request  
minimum order 6 pieces - € per meter*

*Mesures speciaux sur demande  
commande minimale 6 pièces - € le mètre*

*Medidas especiales a demanda  
pedido minimo 6 piezas - € al metro*

300	35	3	FC598300351	17,60	FC598300352	60,50
310	35	3	FC598310351	18,20	FC598310352	62,50
350	35	3	FC598350351	20,50	FC598350352	70,60
400	35	3	FC598400351	23,40	FC598400352	80,60
410	35	3	FC598410351	24,00	FC598410352	82,70
430	35	3	FC598430351	25,20	FC598430352	86,70
450	35	3	FC598450351	26,40	FC598450352	90,70
460	35	3	FC598460351	27,00	FC598460352	92,70
500	35	3	FC598500351	29,30	FC598500352	100,80
510	35	3	FC598510351	29,90	FC598510352	102,80
520	35	3	FC598520351	30,50	FC598520352	104,80
530	35	3	FC598530351	31,00	FC598530352	106,80
600	35	3	FC598600351	35,10	FC598600352	120,90
700	35	3	FC598700351	41,00	FC598700352	141,10
810	35	3	FC598810351	47,40	FC598810352	163,30
1000	35	3	FC5981000351	58,50	FC5981000352	201,50
1070	35	3	FC5981070351	62,60	FC5981070352	215,60

MISURE SPECIALI A RICHIESTA ORDINE MINIMO 6 PEZZI - € AL METRO 58,50 201,50

*Special measures on request  
minimum order 6 pieces - € per meter*

*Mesures speciaux sur demande  
commande minimale 6 pièces - € le mètre*

*Medidas especiales a demanda  
pedido minimo 6 piezas - € al metro*

## CONFEZIONE DI 2 PEZZI - PREZZO AL PEZZO

*Packet of 2 pieces - Price for each piece    Paquet de 2 pièces - Prix pour chaque pièce    Paquete de 2 piezas - Precio para cada pieza*

## COLTELLI CORRUGATI PROFILABILI DA PIALLA

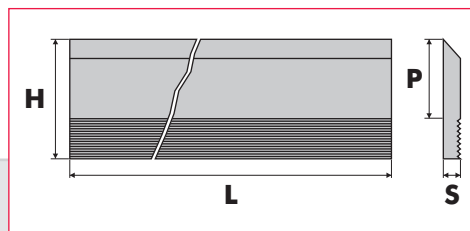

(GB) Corrugated knives for cutterhead   
 (F) Couteaux bruts pour porte-outils   
 (E) Cuchillas a perfilar para cabezail

L	H	S	COD	HSS 18% W€
130	30	5	FC600130301	24,50
150	30	5	FC600150301	34,25
230	30	5	FC600230301	49,80
310	30	5	FC600310301	65,50
40	40	5	FC60040401	11,50
60	40	5	FC60060401	17,70
80	40	5	FC60080401	21,90
100	40	5	FC600100401	26,10
130	40	5	FC600130401	32,50
150	40	5	FC600150401	36,70
170	40	5	FC600170401	40,90
180	40	5	FC600180401	43,00
190	40	5	FC600190401	45,20
210	40	5	FC600210401	49,40
230	40	5	FC600230401	53,60
240	40	5	FC600240401	55,70
270	40	5	FC600270401	62,00
310	40	5	FC600310401	70,50
40	50	8	FC60040501	15,00
60	50	8	FC60060501	20,00
80	50	8	FC60080501	25,00
100	50	8	FC600100501	30,00
130	50	8	FC600130501	37,50
150	50	8	FC600150501	42,50
180	50	8	FC600180501	50,00
230	50	8	FC600230501	62,50
650	50	8	FC600650501	162,50
40	60	8	FC60040601	15,60
60	60	8	FC60060601	20,90
80	60	8	FC60080601	26,20
100	60	8	FC600100601	31,50
130	60	8	FC600130601	39,50
150	60	8	FC600150601	44,80
180	60	8	FC600180601	52,70
230	60	8	FC600230601	66,00
650	60	8	FC600650601	172,50
40	70	8	FC60040701	16,20
60	70	8	FC60060701	21,80
80	70	8	FC60080701	27,40
100	70	8	FC600100701	33,00
130	70	8	FC600130701	41,40
150	70	8	FC600150701	47,00
180	70	8	FC600180701	55,40
230	70	8	FC600230701	69,40
650	70	8	FC600650701	182,00

COLTELLI H=30 E H=40 AFFILATI - BILANCIATI  
 H=30 AND H=40 SHARP KNIVES - BALANCED  
 COUTEAUX H=30 ET H=40 AIGUISÉS - ÉQUILIBRÉS  
 CUCHILLAS H=30 Y=40 AFILADOS - EQUILBRADOS

CONFEZIONE DI 2 PEZZI - PREZZO AL PEZZO

Packet of 2 pieces - Price for each piece    Paquet de 2 pièces - Prix pour chaque pièce    Paquete de 2 piezas - Precio para cada pieza

FR

602

## COLTELLI DA PIALLA PER SISTEMA CENTROLOCK

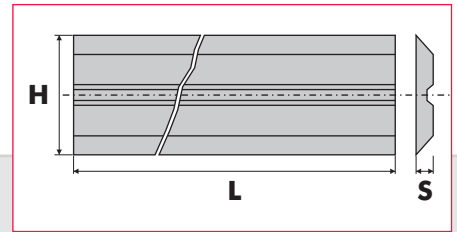

(GB) Planing knives for centrolock system  
 (F) Couteaux a raboter pour systeme centrolock  
 (E) Cuchillas cepilladoras para sistema centrolock

L	H	S	COD	HSS 18% W€	COD	HM€
20	16	3	FC602201	10,80	FC602202	30,90
30	16	3	FC602301	10,80	FC602302	45,90
40	16	3	FC602401	10,80	FC602402	45,90
50	16	3	FC602501	10,80	FC602502	45,90
60	16	3	FC602601	10,80	FC602602	45,90
80	16	3	FC602801	12,00	FC602802	32,70
100	16	3	FC6021001	12,40	FC6021002	42,40
130	16	3	FC6021301	14,30	FC6021302	52,70
140	16	3	FC6021401	14,90	FC6021402	56,50
150	16	3	FC6021501	15,50	FC6021502	57,20
160	16	3	FC6021601	16,10	FC6021602	58,70
170	16	3	FC6021701	16,70	FC6021702	60,20
180	16	3	FC6021801	17,30	FC6021802	61,70
190	16	3	FC6021901	18,10	FC6021902	72,20
210	16	3	FC6022101	19,50	FC6022102	76,40
220	16	3	FC6022201	20,40	FC6022202	78,50
230	16	3	FC6022301	21,30	FC6022302	80,80
240	16	3	FC6022401	21,90	FC6022402	87,80
260	16	3	FC6022601	23,30	FC6022602	93,20
270	16	3	FC6022701	24,00	FC6022702	100,20
300	16	3	FC6023001	26,20	FC6023002	118,10
310	16	3	FC6023101	27,00	FC6023102	122,00
460	16	3	FC6024601	38,90	FC6024602	176,70
650	16	3	FC6026501	58,80	FC6026502	350,60
710	16	3	FC6027101	64,30	-	-
810	16	3	FC6028101	73,40	-	-
1050	16	3	FC60210501	95,10	-	-

## COLTELLI DA PIALLA PER SISTEMA TERSA

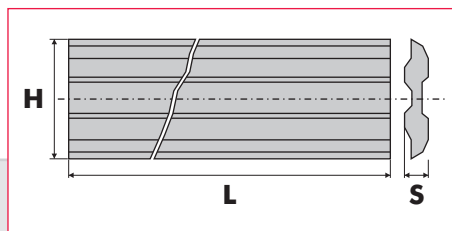

**GB** Planer knives  
for tersa system

**F** Couteaux a raboter  
pour systeme tersa

**E** Cuchillas cepilladoras  
para sistema tersa

L	H	S	COD	HSS 18% W€	COD	HM€
60	10	2,3	FC603601	3,80	FC603602	28,80
80	10	2,3	FC603801	4,80	FC603802	35,30
90	10	2,3	FC603901	5,20	FC603902	38,30
100	10	2,3	FC6031001	5,80	FC6031002	41,20
110	10	2,3	FC6031101	6,30	FC6031102	46,70
120	10	2,3	FC6031201	6,80	FC6031202	50,30
130	10	2,3	FC6031301	7,30	FC6031302	53,90
140	10	2,3	FC6031401	7,80	FC6031402	57,40
150	10	2,3	FC6031501	8,20	FC6031502	61,00
160	10	2,3	FC6031601	8,80	FC6031602	63,00
170	10	2,3	FC6031701	8,90	FC6031702	65,00
180	10	2,3	FC6031801	9,50	FC6031802	68,50
190	10	2,3	FC6031901	10,20	FC6031902	74,10
200	10	2,3	FC6032001	10,30	FC6032002	77,80
210	10	2,3	FC6032101	10,80	FC6032102	78,40
220	10	2,3	FC6032201	11,10	FC6032202	83,60
230	10	2,3	FC6032301	11,30	FC6032302	86,60
240	10	2,3	FC6032401	11,60	FC6032402	90,10
250	10	2,3	FC6032501	11,70	FC6032502	93,90
260	10	2,3	FC6032601	12,20	FC6032602	97,40
270	10	2,3	FC6032701	12,60	FC6032702	100,90
280	10	2,3	FC6032801	12,90	FC6032802	104,50
300	10	2,3	FC6033001	13,80	FC6033002	111,60
310	10	2,3	FC6033101	14,30	FC6033102	115,20
320	10	2,3	FC6033201	14,80	FC6033202	117,80
350	10	2,3	FC6033501	15,80	FC6033502	125,60
360	10	2,3	FC6033601	16,20	FC6033602	129,50
400	10	2,3	FC6034001	17,40	FC6034002	144,20
410	10	2,3	FC6034101	17,80	FC6034102	147,80
420	10	2,3	FC6034201	18,20	FC6034202	152,10
430	10	2,3	FC6034301	18,60	FC6034302	155,90
450	10	2,3	FC6034501	19,70	FC6034502	159,70
460	10	2,3	FC6034601	20,90	FC6034602	163,40
500	10	2,3	FC6035001	22,10	FC6035002	181,30
510	10	2,3	FC6035101	22,60	FC6035102	185,00
520	10	2,3	FC6035201	23,00	FC6035202	188,80
530	10	2,3	FC6035301	23,20	FC6035302	192,50
540	10	2,3	FC6035401	23,60	FC6035402	233,50
600	10	2,3	FC6036001	26,10	FC6036002	259,50
610	10	2,3	FC6036101	26,50	FC6036102	263,70
630	10	2,3	FC6036301	27,30	FC6036302	272,30
640	10	2,3	FC6036401	28,40	FC6036402	276,60
650	10	2,3	FC6036501	29,10	FC6036502	280,90
710	10	2,3	FC6037101	31,80	-	-
810	10	2,3	FC6038101	36,30	-	-
1050	10	2,3	FC60310501	47,10	-	-

# COLTELLI DA PIALLA PER SISTEMA TERMINUS

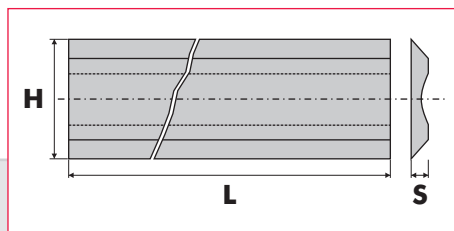

**GB** Planer knives for terminus system    **F** Couteaux a raboter pour systeme terminus    **E** Cuchillas cepilladoras para sistema terminus

L	H	S	COD	HSS 18% W€	COD	HM€
50	14	2,55	FC604501	4,40	FC604502	38,30
60	14	2,55	FC604601	5,20	FC604602	44,10
80	14	2,55	FC604801	6,90	FC604802	55,40
100	14	2,55	FC6041001	8,70	FC6041002	66,90
110	14	2,55	FC6041101	9,50	FC6041102	72,80
120	14	2,55	FC6041201	10,40	FC6041202	78,50
130	14	2,55	FC6041301	11,30	FC6041302	84,10
136	14	2,55	FC6041361	11,80	FC6041362	88,00
140	14	2,55	FC6041401	12,10	FC6041402	89,90
150	14	2,55	FC6041501	13,00	FC6041502	95,60
160	14	2,55	FC6041601	13,90	FC6041602	101,50
170	14	2,55	FC6041701	14,70	FC6041702	107,20
180	14	2,55	FC6041801	15,60	FC6041802	112,80
190	14	2,55	FC6041901	16,40	FC6041902	118,50
200	14	2,55	FC6042001	17,30	FC6042002	124,20
210	14	2,55	FC6042101	18,20	FC6042102	130,10
220	14	2,55	FC6042201	19,00	FC6042202	135,80
230	14	2,55	FC6042301	19,90	FC6042302	141,50
240	14	2,55	FC6042401	20,80	FC6042402	147,30
250	14	2,55	FC6042501	21,60	FC6042502	152,90
255	14	2,55	FC6042551	22,10	FC6042552	155,60
260	14	2,55	FC6042601	22,50	FC6042602	158,80
270	14	2,55	FC6042701	23,30	FC6042702	164,50
275	14	2,55	FC6042751	23,80	FC6042752	168,50
280	14	2,55	FC6042801	24,20	FC6042802	170,20
300	14	2,55	FC6043001	25,90	FC6043002	181,60
310	14	2,55	FC6043101	26,80	FC6043102	187,40
330	14	2,55	FC6043301	28,50	FC6043302	198,90
350	14	2,55	FC6043501	30,30	FC6043502	210,20
360	14	2,55	FC6043601	31,10	FC6043602	216,10
400	14	2,55	FC6044001	34,60	FC6044002	238,90
410	14	2,55	FC6044101	35,40	FC6044102	244,80
420	14	2,55	FC6044201	36,30	FC6044202	250,50
430	14	2,55	FC6044301	37,20	FC6044302	256,20
450	14	2,55	FC6044501	38,90	FC6044502	267,60
480	14	2,55	FC6044801	41,50	FC6044802	285,40
500	14	2,55	FC6045001	43,20	FC6045002	296,20
510	14	2,55	FC6045101	44,10	FC6045102	302,10
520	14	2,55	FC6045201	44,90	FC6045202	307,80
530	14	2,55	FC6045301	45,80	FC6045302	313,60
610	14	2,55	FC6046101	52,70	FC6046102	359,40
620	14	2,55	FC6046201	53,60	FC6046202	365,20
630	14	2,55	FC6046301	54,40	FC6046302	370,90
640	14	2,55	FC6046401	55,30	FC6046402	376,60
650	14	2,55	FC6046501	56,10	FC6046502	382,20
710	14	2,55	FC6047101	61,30	-	-
810	14	2,55	FC6048101	70,00	-	-
1050	14	2,55	FC60410501	90,70	-	-

# COLTELLI DA PIALLA PER SISTEMA CENTROFIX

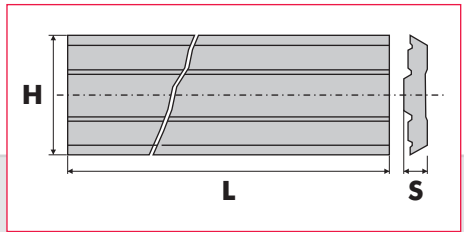

(GB) Planer knives for centrofix system   
 (F) Couteaux a raboter pour systeme centrofix   
 (E) Cuchillas cepilladoras para sistema centrofix

L	H	S	COD	HSS 18% W€	COD	HM€
50	12	2,7	FC605501	5,20	FC605502	42,90
80	12	2,7	FC605801	8,30	FC605802	42,90
100	12	2,7	FC6051001	9,80	FC6051002	42,90
120	12	2,7	FC6051201	11,10	FC6051202	48,90
130	12	2,7	FC6051301	11,30	FC6051302	52,20
150	12	2,7	FC6051501	13,00	FC6051502	59,30
170	12	2,7	FC6051701	14,70	FC6051702	64,30
180	12	2,7	FC6051801	15,60	FC6051802	67,40
190	12	2,7	FC6051901	16,40	FC6051902	71,10
210	12	2,7	FC6052101	18,20	FC6052102	78,50
230	12	2,7	FC6052301	19,90	FC6052302	82,00
240	12	2,7	FC6052401	20,70	FC6052402	91,00
310	12	2,7	FC6053101	26,80	FC6053102	117,50
400	12	2,7	FC6054001	34,60	FC6054002	157,90
410	12	2,7	FC6054101	35,40	FC6054102	161,70
420	12	2,7	FC6054201	36,30	FC6054202	165,50
430	12	2,7	FC6054301	37,10	FC6054302	169,20
500	12	2,7	FC6055001	43,20	FC6055002	195,90
510	12	2,7	FC6055101	44,10	FC6055102	199,50
520	12	2,7	FC6055201	44,90	FC6055202	203,30
530	12	2,7	FC6055301	45,80	FC6055302	206,80
540	12	2,7	FC6055401	46,60	FC6055402	210,80
630	12	2,7	FC6056301	54,40	FC6056302	318,50
640	12	2,7	FC6056401	55,20	FC6056402	323,60
650	12	2,7	FC6056501	56,10	FC6056502	328,60
710	12	2,7	FC6057101	61,30	-	-
810	12	2,7	FC6058101	69,90	-	-
1050	12	2,7	FC60510501	90,70	-	-

F

R

6

0

6

## COLTELLI DA PIALLA PER SISTEMA VARIPLAN

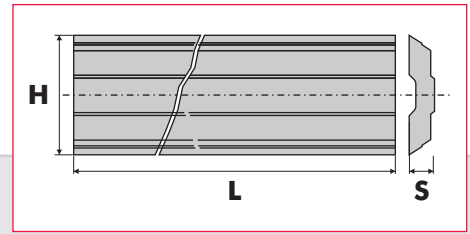

Planer knives for  
variplan system



Couteaux a raboter  
pour systeme variplan



Cuchillas cepilladoras  
para sistema variplan

L	H	S	COD	HSS 18% W€	COD	HM€
50	16	3,7	FC606501	10,20	FC606502	50,30
60	16	3,7	FC606601	10,20	FC606602	50,30
80	16	3,7	FC606801	12,60	FC606802	38,50
100	16	3,7	FC6061001	15,70	FC6061002	44,50
120	16	3,7	FC6061201	16,90	FC6061202	52,90
130	16	3,7	FC6061301	18,30	FC6061302	56,70
136	16	3,7	FC6061361	19,20	FC6061362	59,30
150	16	3,7	FC6061501	20,20	FC6061502	64,20
170	16	3,7	FC6061701	21,80	FC6061702	71,20
180	16	3,7	FC6061801	22,40	FC6061802	74,10
190	16	3,7	FC6061901	23,60	FC6061902	78,20
210	16	3,7	FC6062101	26,10	FC6062102	90,00
230	16	3,7	FC6062301	27,70	FC6062302	96,70
240	16	3,7	FC6062401	28,40	FC6062402	100,40
260	16	3,7	FC6062601	29,60	FC6062602	108,80
270	16	3,7	FC6062701	30,90	FC6062702	113,00
310	16	3,7	FC6063101	35,20	FC6063102	129,70
320	16	3,7	FC6063201	36,30	FC6063202	153,40
410	16	3,7	FC6064101	46,30	FC6064102	196,60
420	16	3,7	FC6064201	47,80	FC6064202	201,40
520	16	3,7	FC6065201	56,60	FC6065202	236,60
540	16	3,7	FC6065401	58,80	FC6065402	245,70
630	16	3,7	FC6066301	66,50	FC6066302	270,60
650	16	3,7	FC6066501	68,70	FC6066502	279,20



F

R

6

0

7

## COLTELLI DA PIALLA PER SISTEMA SINUS

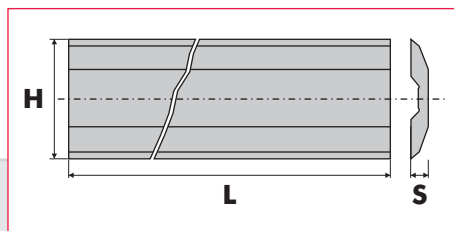

**GB** Planer knives  
for sinus system

**F** Couteaux a raboter  
pour systeme sinus

**E** Cuchillas cepilladoras  
para sistema sinus

L	H	S	COD	HSS 18% W€	COD	HM€
80	16	2,5	FC607801	14,70	FC607802	82,20
100	16	2,5	FC6071001	15,00	FC6071002	99,90
120	16	2,5	FC6071201	15,30	FC6071202	116,40
130	16	2,5	FC6071301	15,90	FC6071302	122,40
140	16	2,5	FC6071401	16,20	FC6071402	131,80
150	16	2,5	FC6071501	17,40	FC6071502	141,20
160	16	2,5	FC6071601	17,90	FC6071602	150,60
180	16	2,5	FC6071801	19,20	FC6071802	164,30
190	16	2,5	FC6071901	19,30	FC6071902	170,70
200	16	2,5	FC6072001	20,40	FC6072002	179,70
210	16	2,5	FC6072101	21,40	FC6072102	188,80
220	16	2,5	FC6072201	22,40	FC6072202	197,70
230	16	2,5	FC6072301	23,40	FC6072302	206,80
240	16	2,5	FC6072401	24,40	FC6072402	215,70
250	16	2,5	FC6072501	25,40	FC6072502	224,80
260	16	2,5	FC6072601	26,50	FC6072602	233,60
300	16	2,5	FC6073001	30,50	FC6073002	269,60
310	16	2,5	FC6073101	31,50	FC6073102	278,70
400	16	2,5	FC6074001	40,70	FC6074002	359,40
410	16	2,5	FC6074101	41,70	FC6074102	368,50
430	16	2,5	FC6074301	43,70	FC6074302	386,50
500	16	2,5	FC6075001	50,80	FC6075002	449,30
510	16	2,5	FC6075101	51,80	FC6075102	458,40
610	16	2,5	FC6076101	62,00	FC6076102	548,30
630	16	2,5	FC6076301	64,00	FC6076302	566,20
640	16	2,5	FC6076401	65,00	FC6076402	575,00
710	16	2,5	FC6077101	72,20	-	-
1050	16	2,5	FC60710501	106,70	-	-

FR

## COLTELLI DA PIALLA PER SISTEMA BULLDOZER

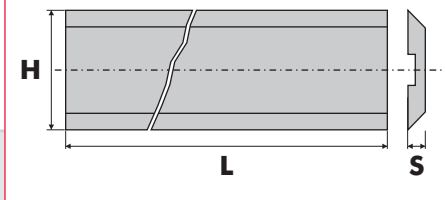

**GB** Planer knives for bulldozer system **F** Couteaux a raboter pour systeme bulldozer **E** Cuchillas cepilladoras para sistema bulldozer

L	H	S	COD	HM€
60	13,6	1,8	FC608602	23,30
70	13,6	1,8	FC608702	27,20
80	13,6	1,8	FC608802	31,10
100	13,6	1,8	FC6081002	38,80
110	13,6	1,8	FC6081102	42,70
120	13,6	1,8	FC6081202	46,60
130	13,6	1,8	FC6081302	50,50
140	13,6	1,8	FC6081402	54,30
150	13,6	1,8	FC6081502	58,20
160	13,6	1,8	FC6081602	62,10
180	13,6	1,8	FC6081802	69,80
190	13,6	1,8	FC6081902	73,70
200	13,6	1,8	FC6082002	77,60
220	13,6	1,8	FC6082202	85,40
230	13,6	1,8	FC6082302	89,20
240	13,6	1,8	FC6082402	93,10
250	13,6	1,8	FC6082502	97,00
260	13,6	1,8	FC6082602	100,90

**GDA**  
High-tech tools

FR

## COLTELLI DA PIALLA PER SISTEMA ENSHIN

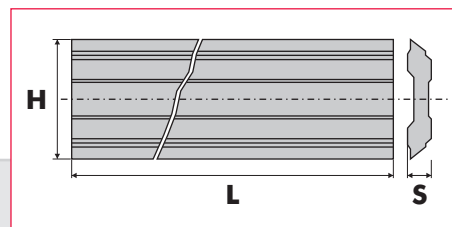

**GB** Planer knives for enshin system **F** Couteaux a raboter pour systeme enshin **E** Cuchillas cepilladoras para sistema enshin

L	H	S	COD	HSS 18% W€	COD	HM€
80	12	2,7	FC609801	19,90	FC609802	70,10
100	12	2,7	FC6091001	23,00	FC6091002	87,60
130	12	2,7	FC6091301	27,60	FC6091302	114,10
150	12	2,7	FC6091501	29,20	FC6091502	131,60
170	12	2,7	FC6091701	31,60	FC6091702	149,20
180	12	2,7	FC6091801	31,80	FC6091802	157,70
190	12	2,7	FC6091901	33,60	FC6091902	166,70
210	12	2,7	FC6092101	37,20	FC6092102	184,20
230	12	2,7	FC6092301	40,70	FC6092302	201,70
240	12	2,7	FC6092401	42,50	FC6092402	210,30
260	12	2,7	-	-	FC6092602	227,80
380	12	2,7	FC6093801	67,20	-	-
640	12	2,7	-	-	FC6096402	534,60

**GDA**  
High-tech tools

## COLTELLI REVERSIBILI

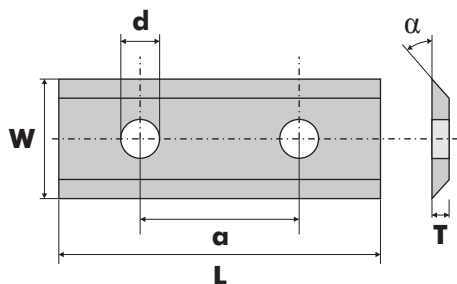

- GB** Reversible knives
- F** Couteaux reversibles
- E** Cuchillas reversibles

MATERIALI / MATERIALS / MATERIAUX / MATERIALES	T03SMG	T04F	T08MF	T10MG
HDF, MDF	●●●	●●	—	●
TRUCIOLARE / CHIPBOARD PANNEAUX DE PARTICULE / PANEL DE AGLOMERADO	●●●●	●●●	—	●
LEGNO DURO / HARDWOOD BOIS DUR / MADERA DURA	●●	●●	●●	●●●
LEGNO TENERO / SOFTWOOD BOIS TENDRE / MADERA BLANDA	—	●●	●●	●●●
LEGNO INCOLLATO / GLUED-UP WOOD BOIS COLLE' / MADERA ENCOLA	—	●●	●	●●

— Poco idoneo / Poor / Mal adapté / Nada apropiad      ●● Buono / Good / Bon / Bueno      ●●●● Ottimo / Excellent / Excellent / Optimo  
 ● Possibile / Possible / Possible / Possible      ●●● Molto idoneo / Very Good / Très Bien / Muy

	L	W	T	α	α	Z	T04F	€	T03SMG	€	T08MF	€
<b>Z=2 / 35°</b> 	7.5	12.0	1.5		35°	2	FC612012001	1,80	FC612013811	2,70		
	9.6	12.0	1.5		35°	2	FC612012015	2,40				
	15.0	12.0	1.5		35°	2	FC612012003	2,10				
	20.0	12.0	1.5		35°	2	FC612012004	2,40	FC612013823	3,00		
	25.0	12.0	1.5		35°	2	FC612012025	3,40				
<b>Z=2 / 35°</b> 	25.0	12.0	1.5	14.0	35°	2	FC612012011	3,40				
	30.0	12.0	1.5	14.0	35°	2	FC612012005	2,80	FC612013828	3,60		
	40.0	12.0	1.5	26.0	35°	2	FC612012014	3,90	FC612013847	4,60		
	50.0	12.0	1.5	26.0	35°	2	FC612012006	4,20	FC612013834	5,30		
	60.0	12.0	1.5	26.0	35°	2	FC612012007	5,30	FC612013839	6,10		
<b>Z=2 / 35°</b> 	80.0	13.0	2.2	60.0	35°	2					FC612012008	17,00
	100.0	13.0	2.2	60.0	35°	2					FC612012009	22,60
	120.0	13.0	2.2	60.0	35°	2					FC612012010	28,30
	L	W	T	α	α	Z	T04F	€	T08MF	€	T10MG	€
<b>Z=4 STANDARD</b> 	12.0	12.0	1.5	4.0	35°	4	FC612012002	2,00				
<b>Z=4 INCISORI</b> 	14.0	14.0	1.2		30°	4			FC612013295	2,40		
<b>Z=4 INCISORI</b> 	14.0	14.0	2.0		30°	4			FC612013273	2,00		
	15.0	15.0	2.5		30°	4					FC612013315	4,00
	L	W	T	α	α	Z	T04F	€	T03SMG	€		
<b>Z=4 - 3 FORI</b> 	50.0	12.0	1.7	37.0	35°	4	FC612013327	6,60	FC612013866	8,30		
<b>Z=3 - SPECIALE</b> 	16.0	7.0	1.5	7.0		3	FC612016934	5,90	FC612016933	7,40		
	28.0	7.0	1.5	14.0		3	FC612016823	7,50	FC612016822	8,30		

## COLTELLI REVERSIBILI

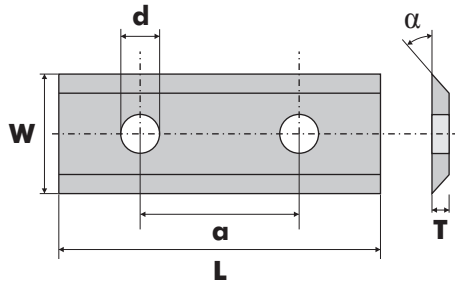

- GB** Reversible knives
- F** Couteaux reversibles
- E** Cuchillas reversibles

	L	W	T	d	$\alpha$	Z	T10MG	€				
<b>Z=2 / 45°</b> 	20.0	12.0	1.5		45°	2	FC612014100	4,60				
<b>Z=2 / 45°</b> 	30.0 50.0	12.0	1.5	14.0 26.0	45° 45°	2	FC612014102 FC612014105	4,80 6,60				
<b>Z=4</b> 	19,5	12.0	1.5			4	FC612013498	4,50				
<b>Z=4</b> 	29,5 49,5	12.0	1.5			4 4	FC612013507 FC612013520	4,40 6,10				
<b>Z=4 / 45°</b> 	12.0	12.0	1.5		45°	4	FC612014096	4,30				
	L	W	T	d	$\alpha$	Z	T08MF	€	T10MG	€		
<b>Z=4 INCISORI</b> 	21.0	21.0	5.5		40°	4			FC612022695	11,40		
<b>Z=4 ROMPIRUCIOLO</b> 	15.0	15.0	2.0			4	FC612013322	7,60				
<b>Z=4 CON RAGGIO</b> 	15.0 15.0	15.0	2.5		R=150 R=50	4 4			FC612013320 FC612043895	4,80 4,80		
	L	W	T	d	$\alpha$	Z	T08MF	€				
<b>COLTELLO DA INCASTRO</b> 	18.0 18.0 18.0	18.0	1.95 2.45 2.95			4 4 4	FC612013293 FC612013291 FC612013305	6,50 8,50 9,40				
<b>TRIANGOLARE</b> 	22.0	19.0	2.0		30°	3	FC612013271	5,50				

CONFEZIONE DI 10 PEZZI - PREZZO AL PEZZO

Packet of 10 pieces - Price for each piece Paquet de 10 pièces - Prix pour chaque pièce Paquete de 10 piezas - Precio para cada pieza

# LAME PER SEGHE A NASTRO PER LEGNO

**GB** Band saw blades

**F** Lames de scies a ruban

**E** Hojas de sierra de cinta

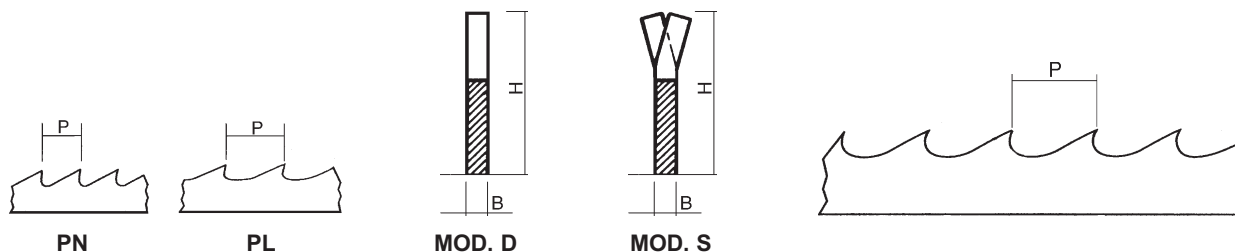

H	B	PN	PL	SOLO DENTATO ONLY TOOTHED - SELLEMENT DENTE - SOLAMENTE DENTADO				AFFILATO/STRADATO SHARPENIG - A FILE - AFILADO			
				MOD. D ACCIAIO NiCr	€	MOD. D ACCIAIO UDD	€	MOD. S ACCIAIO NiCr	€	MOD. S ACCIAIO UDD	€
10	0.4	6-8	-	SN650111004	1,80	SN650121004	3,50	SN650211004	3,90	SN650221004	5,70
10	0.5	6-8	-	SN650111005	2,00	SN650121005	3,60	SN650211005	4,00	SN650221005	5,80
10	0.6	6-8	-	SN650111006	2,20	SN650121006	3,70	SN650211006	4,20	SN650221006	5,90
10	0.7	6-8	-	SN650111007	2,40	SN650121007	4,00	SN650211007	4,40	SN650221007	6,40
15	0.4	6-8-10	-	SN650111504	2,10	SN650121504	3,50	SN650211504	4,10	SN650221504	5,70
15	0.5	6-8-10	-	SN650111505	2,20	SN650121505	3,70	SN650211505	4,40	SN650221505	5,80
15	0.6	6-8-10	-	SN650111506	2,40	SN650121506	4,00	SN650211506	4,60	SN650221506	6,40
15	0.7	8-10	-	SN650111507	2,60	SN650121507	4,50	SN650211507	4,80	SN650221507	7,00
15	0.8	8-10	-	SN650111508	2,80	SN650121508	5,00	SN650211508	5,00	SN650221508	7,40
20	0.4	6-8-10	-	SN650112004	2,40	SN650122004	4,00	SN650212004	4,60	SN650222004	6,60
20	0.5	6-8-10	-	SN650112005	2,50	SN650122005	4,20	SN650212005	4,80	SN650222005	6,80
20	0.6	6-8-10	-	SN650112006	2,80	SN650122006	4,40	SN650212006	4,90	SN650222006	7,00
20	0.7	8-10	-	SN650112007	2,90	SN650122007	5,00	SN650212007	5,10	SN650222007	7,70
20	0.8	8-10	-	SN650112008	3,00	SN650122008	5,90	SN650212008	5,30	SN650222008	8,50
25	0.5	6-8-10	-	SN650112505	2,90	SN650122505	4,80	SN650212505	5,10	SN650222505	7,50
25	0.6	6-8-10	12	SN650112506	3,00	SN650122506	5,00	SN650212506	5,30	SN650222506	7,70
25	0.7	8-10	12	SN650112507	3,50	SN650122507	5,50	SN650212507	5,60	SN650222507	8,40
25	0.8	8-10	12	SN650112508	3,60	SN650122508	6,20	SN650212508	5,80	SN650222508	9,20
30	0.5	8-10	-	SN650113005	4,00						
30	0.6	8-10	12-14	SN650113006	3,50	SN650123006	5,60	SN650213006	5,60	SN650223006	8,50
30	0.7	8-10	12-14	SN650113007	3,60	SN650123007	5,80	SN650213007	5,80	SN650223007	8,80
30	0.8	8-10	12-14	SN650113008	3,90	SN650123008	6,80	SN650213008	6,00	SN650223008	9,90
35	0.6	8-10	12-14	SN650113506	3,90	SN650123506	6,60	SN650213506	6,00	SN650223506	9,90
35	0.7	8-10	12-14	SN650113507	4,00	SN650123507	6,80	SN650213507	6,20	SN650223507	10,20
35	0.8	8-10	12-14	SN650113508	4,20	SN650123508	7,40	SN650213508	6,40	SN650223508	10,80
40	0.7	10-12	14-16	SN650114007	4,40	SN650124007	8,20	SN650214007	6,70	SN650224007	12,10
40	0.8	10-12	14-16	SN650114008	4,70	SN650124008	9,20	SN650214008	6,90	SN650224008	13,30
40	0.9	10-12	14-16	SN650114009	5,30	SN650124009	10,80	SN650214009	7,20	SN650224009	15,00
45	0.8	12-14	16-18-20	SN650114508	5,90	SN650124508	11,10				
45	0.9	12-14	16-18-20	SN650114509	6,80	SN650124509	12,70				
50	0.8	12-14	16-18-20	SN650115008	7,00	SN650125008	12,60				
50	0.9	12-14	16-18-20	SN650115009	7,60	SN650125009	14,80				
50	1.0	12-14	16-18-20	SN650115010	8,50	SN650125010	16,80				

## CONFEZIONE

IN ROTOLI DA MT 100 O IN ANELLI A MISURA - MINIMO 10 PEZZI - SALDATURA

€ 8,50

IN COILS 100 MT OR IN RINGS MINIMUM 10 PCS - WELDING

€ 8,50

ENFOULEMENT 100 MT OU EN BOUCHES MINIMUM 10 PCS - SOUNDURE

€ 8,50

EN BOBINAS 100 MT O EN ANILLOS MINIMO 10 PED - SOLDATURA

€ 8,50



## CONDIZIONI GENERALI DI VENDITA

### **ORDINI**

Tutte le ordinazioni dovranno pervenirci con ordine scritto ed eventuali richieste emesse verbalmente avranno valore solo dopo la nostra conferma d'ordine ed alle condizioni in essa riportate. Non si accettano annullamenti, anche parziali, trascorse 24 ore dall'invio dell'ordine se non in via eccezionale, riservandoci comunque il diritto di richiedere il rimborso delle spese sostenute fino a quel momento. Gli ordini non dovranno essere di importo inferiore a € 150,00. Eventuali ordini di minor importo, potranno essere da noi ritardati nella consegna in modo da accumulare diversa merce sino al raggiungimento della cifra minima stabilita. In caso di urgenza, sarà possibile una spedizione anche di valore inferiore, ma verranno addebitati € 25 in fattura quale contributo spese per la gestione dell'ordine.

### **CONSEGNE**

I termini di consegna pattuiti saranno nel possibile rispettati. Eventuali ritardi, conseguenze di disguidi indipendenti dalla nostra volontà, non potranno essere motivo di annullamento o di richieste di indennizzi di nessun genere.

### **SPEDIZIONI**

La merce viene resa franco nostro stabilimento e spedita, salvo accordi stabiliti, con il mezzo da noi ritenuto più vantaggioso. La merce viaggerà sempre a rischio e pericolo del committente. Eventuali assicurazioni dovranno essere esplicitamente richieste e saranno fatturate al costo. L'imballo è sempre a carico del committente ed addebitato al costo.

### **GARANZIA**

Tutti i nostri utensili sono sottoposti ad accurati controlli e sono completamente garantiti. La garanzia esula da danni subiti dalla merce durante il trasporto ed inoltre nessuna garanzia sarà riconosciuta per difetti causati da errata manutenzione, logorio, uso improprio o modifiche effettuate senza la nostra approvazione. Richieste di indennizzi per danni diretti o indiretti, causati da utensili ritenuti difettosi, non saranno da noi accettate.

### **RESTITUZIONE E RECLAMI**

Eventuali reclami per merce sbagliata o difettosa dovranno essere inviati alla nostra sede esclusivamente tramite documentazione scritta indicante il difetto riscontrato ed entro 8 giorni dal ricevimento della merce. La ditta GDA non accetta nessun tipo di reso se non espressamente concordato.

### **PREZZI**

I prezzi si intendono con IVA esclusa, merce resa franco nostra fabbrica ed imballo a carico del committente.

### **PAGAMENTI**

Gli importi delle fatture, salvo accordi diversi, vanno pagati per intero alla scadenza stabilita. Tutte le spese accessorie sono a carico del committente. Il mancato rispetto dei termini di pagamento autorizza la GDA al recupero di ogni spesa accessoria, agli interessi maturati e ad un ulteriore tasso del 5% per il recupero spese, riservandosi inoltre il diritto alla sospensione di eventuali ordini in corso. L'eventuale reclamo di parte della fornitura non dà diritto al ritardo del pagamento per la parte non contestata, né al mancato pagamento di altre fatture in scadenza.

### **DIRITTI D'AUTORE**

Tutti i diritti sono riservati a norma di legge. E' vietato riprodurre o copiare anche parzialmente, testi, disegni, illustrazioni, senza il consenso scritto della G.D.A. s.r.l.

### **FORO COMPETENTE**

Per qualsiasi eventuale controversia il foro competente è quello di Rovereto (TN). Tutti i contratti stipulati sono regolamentati dalla legislazione italiana.

**QUESTO CATALOGO SOSTITUISCE ED ANNULLA OGNI EDIZIONE PRECEDENTE.**



## GENERAL SALES CONDITIONS

### **ORDERS**

All the orders should be reached in writing. About the orders transmitted by telephone, they will be valid only after our order confirmation and with the terms we will write in it. We can't accept cancellation, nor partial, after 24 hours from the date of the order, except special case, and if accepted, it will be our right to ask the reimbursement of the expenses sustained until that moment. The minimum amount for the orders is € 150,00. It could be possible that we'll delay some orders with lower amount to accumulate material to achieve the minimum fixed. In case of urgency for delivery of the order for lower amount we'll debit € 25,00 in the invoice as contribution for the extra costs of the order management.

---

### **DELIVERIES**

The delivery time confirmed will be respected as much as possible. Possible delays that don't depend from our company will can not be reasons to cancel the order or to request any compensation.

---

### **TRANSPORT**

Freight costs and risks will be at the charge of the buyer. Without different agreements, we will ship the material with the most advantageous forwarding agent. Possible insurances must be previously demanded and debited at the real cost in the invoice. The package is at the charge of the buyer and it's debited at the real cost.

---

### **WARRANTY**

All our products are carefully controlled during the manufacturing and they're guaranteed in every aspect. The guarantee doesn't include damages caused during the transport, defects for wrong or improper use, wear and tear and modifications made without our approval. In any case, claims for direct or indirect damages caused from the tools considered defectives will not accepted.

---

### **CLAIMS AND RETOURNS**

Claims for wrong or defective goods have to be communicated by written documentation within 8 days from the receipt of the goods mentioning the defect found. Any restitution will accepted if not previously authorized.

---

### **PRICES**

Prices are considered without VAT that will be imposed with the share in force at the moment of the invoicing. The prices are ex works and the package is excluded.

---

### **PAYMENTS**

Without different agreements, the invoice's amount has to be totally paid at the established deadline (date). All the extra expenses are at the charge of the customer. If the terms of payment are not respected, the GDA can interrupt the supplies and debit the accrued interests, with further interest of 5% to cover the extra costs. Claims for part of supplies don't give the right to postpone the term of payment or to not pay other invoices.

---

### **RESERVED OWNERSHIP RIGHTS**

All rights are reserved in accordance with the law. This catalogue may not be reproduced or copied (even in part) without the written authorization of GDA.

---

### **PLACE OF JURISDICTION**

For every legal matter the place of jurisdiction is Rovereto (TN). All the contracts are regulated by the Italian legislation.

---

**THIS CATALOGUE REPLACE AND CANCEL EVERY PREVIOUS EDITION.**



## CONDITIONS GENERALES DE VENTE

### COMMANDES

Toutes les commandes doivent être envoyées par écrit. Éventuelles demandes téléphoniques seront valides seulement après notre confirmation d'ordre et aux conditions que nous indiquerons dans la même. Nous n'accepterons pas (si non en voie exceptionnelle) des annulations aussi partiels après les 24 heures de l'envoi de l'ordre et nous nous réservons le droit de demander le remboursement des frais pour les matériaux et les travaux jusqu'à ce moment. Les commandes ne devront pas être de valeur inférieure à € 150,00. Pour éventuelles commandes de petit valeur nous pourrons reculer la livraison pour cumuler différente marchandise et rejoindre la chiffre établie. Une livraison de valeur inférieure sera possible pour les urgences, mais nous débitons € 25 dans la facture comme contribution pour les frais pour la gestion de l'ordre.

### LIVRAISON

Nous ferons tout le possible pour respecter les délais de livraison indiqué dans nos confirmations d'ordre, mais éventuels retards en conséquence des erreurs ou problèmes pas dépendants de notre volonté, ne pourront pas être raison de nullement ou des demandes de dommage.

### EXPEDITION

La marchandise, sans différents accords sera livrée départ-usine avec le transporteur que nous estimerons plus convenable. La marchandise voyagera toujours au risque et danger de l'acheteur. Eventuelles assurances devront être formellement demandées et seront facturées au coût. L'emballage est toujours à la charge de l'acheteur et il est débité au coût.

### GARANTIE

Tous nos outils sont soumis à des soigneux contrôles et ils sont complètement garanties. La garantie ne couvre pas éventuels dégâts pendant le transport et aucune garantie sera reconnue pour défauts causés par une entretien erroné, usure impropre, ou modifications effectuées sans notre approbation. Demandes de dommage et intérêts pour dégâts directs ou indirects causés par des outils retenus défectueux ne seront pas acceptées chez nous.

### RESTITUTION ET RECLAMATION

Éventuelles réclamations pour marchandise incorrecte ou défectueuse devront être envoyées exclusivement par documentation écrite, en indiquant le défaut dans 8 jours de la réception de la marchandise. La GDA n'accepte pas aucune restitution si non expressément concordée.

### PRIX

Les prix sont considérés sans V.A.T. Les coûts de transport et d'emballage sont à la charge du client.

### PAIEMENT

Les factures, doivent être entièrement payées, sans différents accords, à l'échéance établie. Tous les frais accessoires sont à la charge du client. Le manqué respect des délais de paiement, autorise la GDA à récupérer chaque frais accessoire, les intérêts échus et avec un ultérieur taux du 5% pour récupérer les frais, en réservant aussi le droit à la suspension des d'éventuelles commande en cours. L'éventuelle réclamation pour une partie de la fourniture ne donne pas le droit au retard pour le paiement de la marchandise pas contestée ni le non paiement d'autres factures.

### DROITS D'AUTEUR

Tous les droits sont réservés aux termes de la loi. La reproduction aussi partielle des dessins, des illustrations ou des textes est interdite l'autorisation écrite de la G.D.A. s.r.l.

### TRIBUNAL COMPETENT

Pour toute éventuelle controverse la compétence sera du tribunal de Rovereto (TN). Tous les contrats sont réglementés par la législation italienne

**CE CATALOGUE ANNULE ET REMPLACE CHAQUE EDITION PRECEDENTE**





## CONDICIONES GENERALES DE VENTA

### **PEDIDOS**

Todas las ordenes nos deberán llegar escritas y con el eventual pedido verbalmente tendrán valor solo después de la nuestra confirmación del orden y las condiciones ya aclaradas. No se aceptan anulamientos, ni parciales, transcurridas las 24 horas del envío del orden si no que en manera excepcional, reservándonos de todas maneras el derecho de pedir el gasto, sostenido hasta ese momento. Las ordenes no deberán ser inferiores a 150€. Eventuales de menor importe, podrán ser de parte nuestra con atraso en la entrega, de manera que se pueda acumular diferente mercadería hasta llegar a la cifra mínima establecida. En el caso de urgencia, será posible una expedición aunque de valor inferior; pero vendrán a su cargo 25€ en factura cual contributo gastos por la gestión del orden.

### **ENTREGAS**

Los términos de entrega de comun acuerdo serán en el posible respetados. Eventuales atrasos, consecuencias de desuso independientes a nuestra voluntad, no podrán ser motivo de anulamiento o de pedidos de indemnización de ningún género.

### **EXPEDICIONES**

Las mercaderías en rendición (franco) por nuestra fábrica y que vendrá enviada, con el pacto de acuerdos establecidos, con el transporte que nosotros consideramos más ventajoso. La mercadería viajará siempre a riesgo y peligro del cliente. Eventuales aseguraciones deberán ser explícitamente pedidas y serán facturadas al costo. El embalaje es siempre a cargo del comitente y viene adeudado al costo.

### **GARANTIA**

Todos los nuestros utensilios son sometidos a acurados controles y son completamente garantidos. La garantía no se responsabiliza de los daños sufridos de la mercadería causados por el transporte y además ninguna garantía será reconocida por defectos causados por errada manutención, desgastes, uso impropio o modificaciones efectuadas sin la nuestra aprobación. Pedidos por indemnización por daños directos o indirectos, causados por utensilios defectuosos, no serán por parte nuestra aceptados.

### **RESTITUCION Y RECLAMOS**

Eventuales reclamos por mercaderías equivocadas o defectuosas deberán ser enviadas a nuestra sede exclusivamente mediante documentación escrita indicando el defecto encontrado y dentro los 8 días del recibimiento de la mercadería. La empresa GDA no acepta ningún tipo de devolución si no es expresamente de comun acuerdo.

### **PRECIOS**

Los precios se entienden con IVA excluida, las mercaderías en rendición (franco) por parte de nuestra fábrica, por lo tanto el embalaje va a cargo del cliente.

### **PAGOS**

Los importes de las facturas, con la excepción de acuerdos diferentes, van pagados por entero a la fecha establecida. Todos los gastos adicionales son a cargo del interesado. El faltado respecto de los términos de pago autoriza la GDA al recupero de cada gasto adicional, los intereses acumulados y además a un interés del 5% del recupero de los gastos, reservándonos además el derecho a la suspensión de eventuales ordenes en curso. Los eventuales reclamos de parte de la provisión no da el derecho al atraso del pago por la parte no contestada, ni al faltado pago de otras facturas en vencimiento.

### **DERECHOS DE AUTOR**

Todos los derechos son reservados a norma de ley. Es prohibido reproducir o copiar aunque parcialmente, textos, dibujos, ilustraciones, sin el consentimiento escrito de la G.D.A. s.r.l.

### **TRIBUNAL COMPETENTE**

Por cualquier controversia el tribunal competente es Rovereto (TN). Todos los contratos estipulados son reglamentados por la legislación italiana.

**ESTE CATALOGO SOSTITUYE Y ANULA TODAS LAS EDICIONES PRECEDENTES.**